

Micrel's Guide to

Designing With Low-Dropout Voltage Regulators

Bob Wolbert

Applications Engineering Manager

Micrel Semiconductor

1849 Fortune Drive

San Jose, CA 95131

Phone: + 1 (408) 944-0800

Fax: + 1 (408) 944-0970

Micrel, The High Performance Analog Power IC Company

Micrel Semiconductor designs, develops, manufactures, and markets high performance analog power integrated circuits on a worldwide basis. These circuits are used in a wide variety of electronic products, including those in cellular communications, portable and desktop computers, and in industrial electronics.

Micrel History

Since its founding in 1978 as an independent test facility of integrated circuits, Micrel has maintained a reputation for excellence, quality and customer responsiveness that is second to none.

In 1981 Micrel acquired its first independent semiconductor processing facility. Initially focusing on custom and specialty fabrication for other IC manufacturers, Micrel eventually expanded to develop its own line of semicustom and standard product Intelligent Power integrated circuits. In 1993, with the continued success of these ventures, Micrel acquired a new 57,000 sq. ft. facility and in 1995 expanded the campus into a 120,000 sq. ft. facility. The new Class 10 facility has allowed Micrel to extend its process and foundry capabilities with a full complement of CMOS/DMOS/Bipolar/NMOS/PMOS processes. Incorporating metal gate, silicon gate, dual metal, dual poly and feature sizes down to 1.5 micron, Micrel is able to offer its customers unique design and fabrication tools.

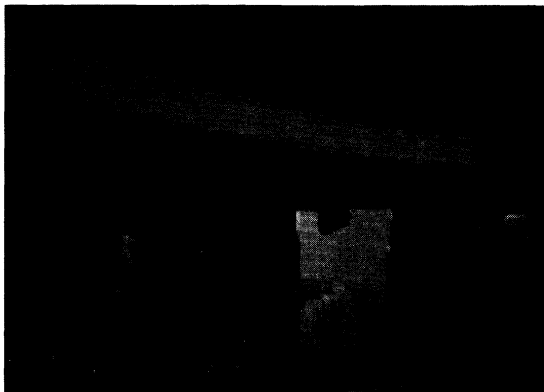

Micrel Today and Beyond

Building on its strength as an innovator in process and test technology, Micrel has expanded and diversified its business by becoming a recognized leader in the high performance analog power control and management markets.

The company's initial public offering in December of 1994 and recent ISO9001 compliance are just two more steps in Micrel's long range strategy to become the preeminent supplier of high performance analog power management and control ICs. By staying close to the customer and the markets they serve, Micrel will continue to remain focused on cost effective standard product solutions for an ever changing world.

The niche Micrel has carved for itself involves:

- **High Performance**.....precision voltages, high technology (Super beta PNP™ process, patented circuit techniques, etc.) combined with the new safety features of overcurrent, overvoltage, and overtemperature protection
- **Analog**.....we control continuously varying outputs of voltage or current as opposed to digital ones and zeros (although we often throw in "mixed signal" i.e. analog with digital controls to bring out the best of both worlds)
- **Power ICs**.....our products involve high voltage, high current, or both

We use this expertise to address the following growing market segments:

1. Power supplies
2. Battery powered computer, cellular phone, and handheld instruments
3. Industrial & display systems
4. Desktop computers
5. Aftermarket automotive
6. Avionics
7. Plus many others

Copyright © 1996 Micrel Incorporated.

All rights reserved. No part of this publication may be reproduced or used in any form or by any means without written permission of Micrel, Incorporated.

Some products in this book are protected by one or more of the following patents: 4,914,546; 4,951,101; 4,979,001; 5,034,346; 5,045,966; 5,047,820; 5,254,486; and 5,355,008. Additional patents are pending.

Designing With LDO Regulators

Table of Contents

	<u>Page</u>
Contributors:.....	viii
Section 1. Introduction: Low Dropout Linear Regulators.....	1
What is a Linear Regulator?.....	1
Why Use Regulators?	1
Basic Design Issues	2
What is a “Low-Dropout” Linear Regulator?.....	3
Linear Regulators versus Switching Regulators	4
Who Prefers Linear Low Dropout Regulators?	4
Section 2. Low Dropout Regulator Design Charts	5
Output Current & Package Type Selector Guide	6
Maximum Power Dissipation by Package Type	7
LDO Selector Guide	8
A Pictorial Guide to Choosing Linear Regulators	10
Pin Compatible Selector Guide	14
Through-Hole Devices	14
Surface Mount Devices	16
Typical Thermal Characteristics	18
Output Current vs. Junction Temperature and Voltage Differential	19
Junction Temperature Rise vs. Available Output Current and Differential Voltage	22
Section 3. Using LDO Linear Regulators	25
General Layout and Construction Considerations	25
Layout	25
Bypass Capacitors	25
Output Capacitor	25
Circuit Board Layout	26
Assembly	26
Lead Bending	27
Heat Sink Attachment	27

Output Voltage Accuracy	28
Adjustable Regulator Accuracy Analysis	28
Improving Regulator Accuracy	29
Regulator & Reference Circuit Performance	30
Design Issues and General Applications	32
Noise and Noise Reduction	32
Stability	32
LDO Efficiency	32
Building an Adjustable Regulator Allowing 0V Output	32
Reference Generates a “Virtual V_{OUT} ”	32
Op-Amp Drives Ground Reference	33
Systems With Negative Supplies	33
High Input Voltages	34
Controlling Voltage Regulator Turn-On Surges	34
The Simplest Approach	35
Improving the Simple Approach	35
Eliminating Initial Start-Up Pedestal	36
Current Sources	37
Simple Current Source	37
The Super LDO Current Source	37
Accurate Current Source Using Op Amps	37
A Low-Cost 12V & 5V Power Supply	37
Computer Power Supplies	39
Dropout Requirements	39
5V to 3.xV Conversion Circuits	40
Method 1: Use a Monolithic LDO	40
Method 2: The MIC5156 “Super LDO”	40
Method 3: The MIC5158 “Super LDO”	41
Method 4: Current Boost a MIC2951	41
Adjust Resistor Values	41
3.3V to 2.xV Conversion	42
Improving Transient Response	42
Accuracy Requirements	43
Multiple Output Voltages	44
Multiple Supply Sequencing	45
Thermal Design	45
Portable Devices	46
Design Considerations	46
Small Package Needed	46
Self Contained Power	46
Low Current (And Low Voltage)	46
Low Output Noise Requirement	46
Dropout and Battery Life	47
Ground Current and Battery Life	47
Battery Stretching Techniques	47
Sleep Mode Switching	47
Power Sequencing	47
Multiple Regulators Provide Isolation	47

Thermal Management.....	48
A Thermal Primer.....	48
Thermal Parameters	48
Thermal/Electrical Analogy	48
Calculating Thermal Parameters	49
Calculating Maximum Allowable Thermal Resistance	50
Why A Maximum Junction Temperature?	50
Heat Sink Charts for High Current Regulators	51
Thermal Examples.....	52
Heat Sink Selection	53
Reading Heat Sink Graphs	53
Power Sharing Resistor	54
Multiple Packages on One Heat Sink	55
Paralleled Devices on a Heat Sink Example	56
Heat Sinking Surface Mount Packages	57
Determining Heat Sink Dimensions	57
SO-8 Calculations:.....	58
Comments	59
Linear Regulator Troubleshooting Guide.....	60
Section 4. Linear Regulator Solutions	61
Super β PNP™ Regulators.....	61
Super β PNP Circuitry	62
Dropout Voltage	62
Ground Current	63
Fully Protected	63
Current Limiting.....	63
Overtemperature Shutdown	63
Reversed Input Polarity	63
Overvoltage Shutdown	64
Variety of Packages.....	64
Why Choose Five Terminal Regulators?	64
Compatible Pinouts.....	64
Stability Issues	65
Paralleling Bipolar Regulators	65
Micrel's Unique "Super LDO™"	67
Micrel's Super LDO Family	67
The MIC5156	67
The MIC5157 and MIC5158	67
3.3V, 10A Regulator Application.....	67
Comparison With Monolithics	68
Similarities to Monolithics	68
Differences from Monolithics	68

Unique Super LDO Applications 68
 Super High-Current Regulator 68
 Selecting the Current Limit Threshold 70
 Sense Resistor Power Dissipation 70
 Kelvin Sensing 70
Alternative Current Sense Resistors 70
Overcurrent Sense Resistors from PC Board Traces 70
 Resistor Design Method 71
 Design Example 71
 Calculate Sheet Resistance 72
 Calculate Minimum Trace Width 72
 Calculate Required Trace Length 72
 Resistor Layout 72
 Thermal Considerations 72
Design Aids 72
 Highly Accurate Current Limiting 72
 Protecting the Super LDO from Long-Term Short Circuits 72

Section 5. Micrel Low-Dropout Regulator Data Sheets 75

MIC5230 10mA Micropower Low-Dropout Linear Regulator 76
 MIC5203 80mA Low-Dropout Voltage Regulator 81
 MIC5200 100mA Low-Dropout Voltage Regulator 87
 MIC5202 Dual 100mA Low-Dropout Voltage Regulator 93
 LP2950/2951 100mA Low-Dropout Voltage Regulator 99
 MIC2950/2951 150mA Low-Dropout Voltage Regulator 100
 MIC5205 150mA Low Noise Low-Dropout Voltage Regulator 115
 MIC5206 150mA Low Noise Low-Dropout Voltage Regulator 122
 MIC5207 180mA Low Noise Low-Dropout Voltage Regulator 129
 MIC5201 200mA Low-Dropout Voltage Regulator 136
 MIC2954 250mA Low-Dropout Voltage Regulator 142
 MIC2920A/29201/29202/29203/29204 400mA LDO Regulator 152
 MIC2937A/29371/29372/29373 750mA Low-Dropout Voltage Regulator 161
 MIC2940A/2941A 1.25A Low-Dropout Voltage Regulator 170
 MIC29150/29151/29152/29153 1.5A Low-Dropout Voltage Regulator 178
 MIC29300/29301/29302/29303 3A Low-Dropout Voltage Regulator 178
 MIC29310/29312 3A Low-Dropout Voltage Regulator 193
 MIC29500/501/502/503 5A Low-Dropout Voltage Regulator 178
 MIC29510/29512 5A Low-Dropout Voltage Regulator 201
 MIC29710/29712 7.5A Low-Dropout Voltage Regulator 209
 MIC29750/29751/29752 7.5A Low-Dropout Voltage Regulator 178
 MIC5156/5157/5158 "Super LDO" 217
 Switching Regulator Selector Guide 228

Section 6: Package Information	229
Packaging for Automatic Handling	230
Tape & Reel Standards	230
Packages Available in Tape & Reel	230
Package Orientation	231
Linear Regulator Packages	232
Section 7. Appendices	243
Appendix A. Table of Standard 1% Resistor Values	244
Appendix B. Table of Standard $\pm 5\%$ and $\pm 10\%$ Resistor Values	245
Appendix C. LDO SINK for the HP 48 Calculator	246
Section 8. Low-Dropout Voltage Regulator Glossary	249
Section 9. References	251
Section 10. Index	252
Section 11. Worldwide Sales Force	255
Micrel Sales Offices	255
U.S. Sales Representatives	256
U.S. Distributors	258
International Sales Representatives and Distributors	262

Contributors:

Jerry Kmetz

Mike Mottola

Jim Cecil

Brian Huffman

Marvin Vander Kooi

Claude Smithson

Micrel Semiconductor
1849 Fortune Drive
San Jose, CA 95131
Phone: + 1 (408) 944-0800
Fax: + 1 (408) 944-0970
<http://www.micrel.com>

Section 1. Introduction:

Low Dropout Linear Regulators

What is a Linear Regulator?

IC linear voltage regulators have been around for decades. These simple-to-use devices appear in nearly every type of electronic equipment, where they produce a clean, accurate output voltage used by sensitive components.

Historically, linear regulators with PNP outputs have been expensive and limited to low current applications. However, Micrel Semiconductor's unique "Super β PNP™" line of low dropout regulators provides up to 7.5 amperes of current with dropout voltages less than 0.6V, guaranteed. A lower cost product line outputs the same currents with only 1V of dropout. These low dropout voltages guarantee the microprocessor gets a clean, well regulated supply that quickly reacts to processor-induced load changes as well as input supply variations.

The low dropout linear voltage regulator is a easy-to-use, low cost, yet high performance means of powering your systems.

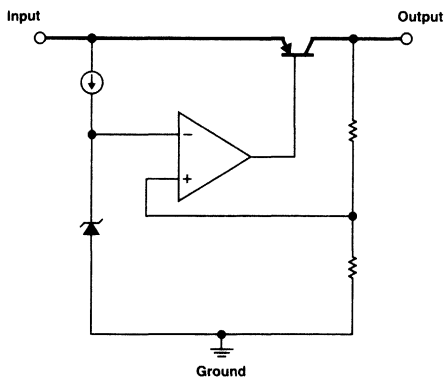

Figure 1-1. A basic linear regulator schematic.

A typical linear regulator diagram is shown in Figure 1-1. A pass transistor is controlled by an operational amplifier which compares the output voltage to a reference. As the output voltage drops, the

op-amp increases drive to the pass element, which increases output voltage. Conversely, if the output rises above the desired set point, the op amp reduces drive. These corrections are performed continuously with the reaction time limited only by the speed of the op amp and output transistor loop.

Real linear regulators have a number of other features, including protection from short circuited loads and overtemperature shutdown. Advanced regulators offer extra features such as overvoltage shutdown, reversed-insertion and reversed polarity protection, and digital error indicators that signal when the output is not correct.

Why Use Regulators?

Their most basic function, voltage regulation, provides clean, constant, accurate voltage to a circuit. Voltage regulators are a fundamental block in the power supplies of most all electronic equipment.

Key regulator benefits and applications include:

- Accurate supply voltage
- Active noise filtering
- Protection from overcurrent faults
- Inter-stage isolation (decoupling)
- Generation of multiple output voltages from a single source
- Useful in constant current sources

Figure 1-2 shows several typical applications for linear voltage regulators. A traditional AC to DC power supply appears in Figure 1-2(A). Here, the linear regulator performs ripple rejection, eliminating AC hum, and output voltage regulation. The power supply output voltage will be clean and constant, independent of AC line voltage variations. Figure 1-2(B) uses a low-dropout linear regulator to provide a constant output voltage from a battery, as the battery discharges. Low dropout regulators are excellent for this application since they allow more usable life from a given battery. Figure 1-2(C) shows a linear regulator configured as a "post regulator" for a switching power

supply. Switching supplies are known for excellent efficiency, but their output is noisy; ripple degrades regulation and performance, especially when powering analog circuits. The linear regulator following the switching regulator provides active filtering and greatly improves the output accuracy of the composite supply. As Figure 1-2(D) demonstrates, some linear regulators serve a double duty as both regulator and power ON/OFF control. In some applications, especially radio systems, different system blocks are often powered from different regulators—even if they use the same supply voltage—because of the isolation (decoupling) the high gain regulator provides.

Basic Design Issues

Let's review the most important parameters of voltage regulators:

- Output voltage is an important parameter, as this is the reason most designers purchase a regulator. Linear regulators are available in both fixed output voltage and adjustable configurations. Fixed voltage regulators offer enhanced ease-of-

use, with their output voltages accurately trimmed at the factory—but only if your application uses an available voltage. Adjustables allow using a voltage custom-tailored for your circuit.

- Maximum output current is the parameter generally used to group regulators. Larger maximum output currents require larger, more expensive regulators.
- Dropout voltage is the next major parameter. This is the minimum additional voltage on the input that still produces a regulated output. For example, a Micrel 5.0V Super β PNP regulator will provide regulated output with an input voltage of 5.3V or above. The 300mV term is the dropout voltage. In the linear regulator world, the lower the dropout voltage, the better.
- Ground current is the supply current used by the regulator that does not pass into the load. An ideal regulator will minimize its ground current. This parameter is sometimes called quiescent current, but this usage is incorrect for PNP-pass element regulators.

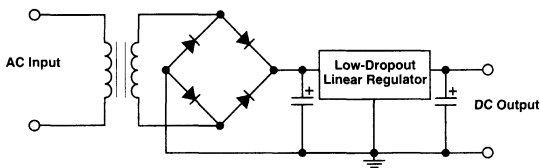

(A) Standard Power Supplies

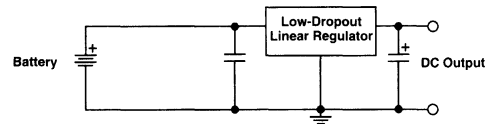

(B) Battery Powered Applications

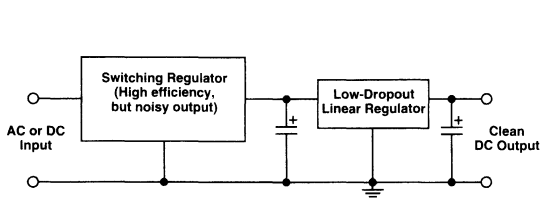

(C) Post-Regulator for Switching Supplies

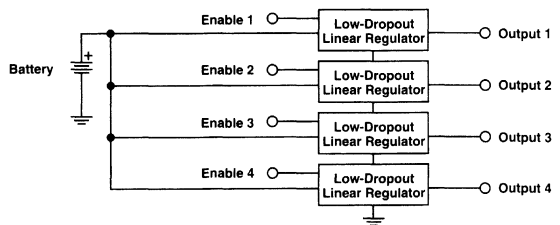

(D) "Sleep-mode" and Inter Stage Isolation or Decoupling

Figure 1-2. Typical Linear Regulator Applications

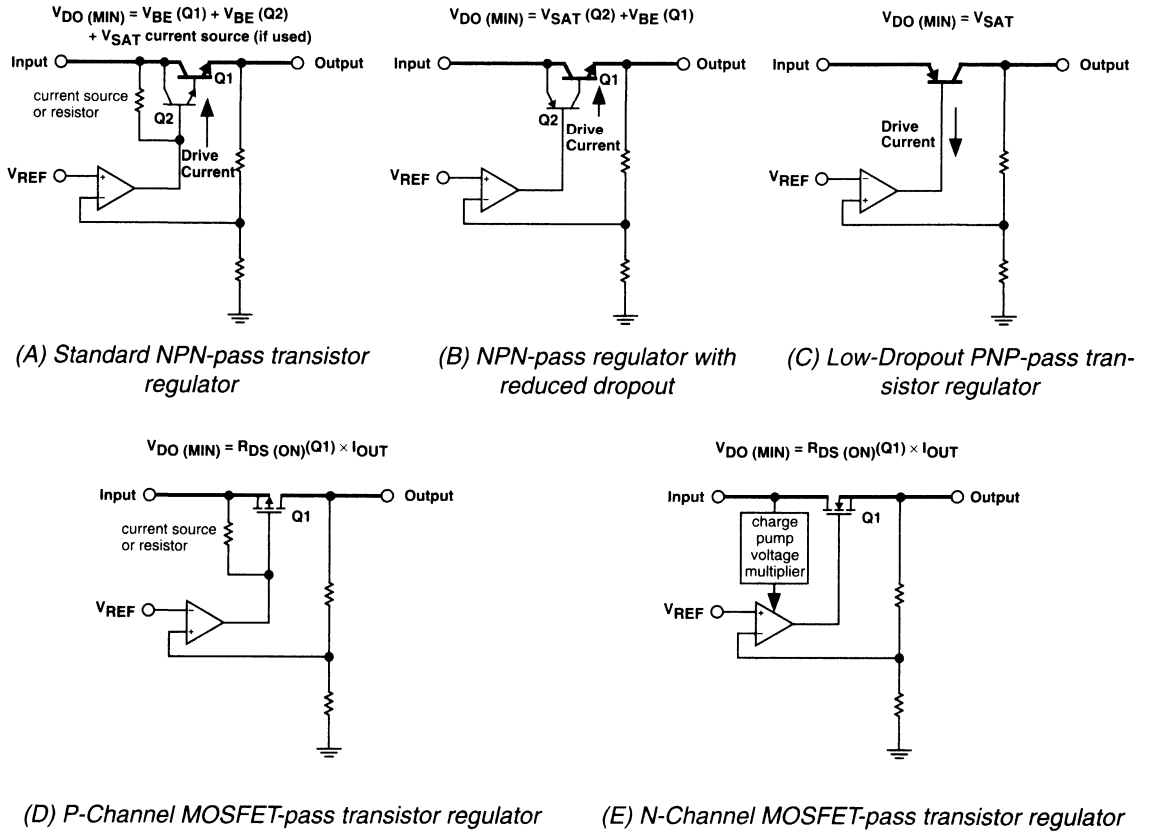

Figure 1-3. The Five Major Types of Linear Regulators

- Efficiency is the amount of usable (output) power achieved from a given input power. With linear regulators, the efficiency is approximately the output voltage divided by the input voltage.

What is a “Low-Dropout” Linear Regulator?

A low dropout regulator is a class of linear regulator that is designed to minimize the saturation of the output pass transistor and its drive requirements. A low-dropout linear regulator will operate with input voltages only slightly higher than the desired output voltage. For example, “classic” linear regulators, such as the 7805 or LM317 need about 2.5 to 3V higher input voltage for a given output voltage. For a 5V output, these older devices need a 8V input. By comparison, Micrel’s Super beta PNP low dropout regu-

lators require only 0.3V of headroom, and would provide regulated output with only 5.3V of input.

Figure 1-3 shows the five major types of linear regulators:

- “Classic” NPN-based regulators that require 2.5 to 3V of excess input voltage to function.
- “Low Dropout NPN” regulators, with a NPN output but a PNP base drive circuit. These devices reduce the dropout requirement to 1.2 to 1.5V.
- True low dropout PNP-based regulators that need 0.3V to 0.6V extra for operation.
- P-channel CMOS output regulators. These devices have very low dropout voltages at low currents but require large die area (hence higher costly than bipolar versions) and have high internal drive current requirements when working with noisy inputs or widely varying output currents.

E. Regulator controllers. These are integrated circuits that provide the reference and control functions of a linear regulator, but do not have the pass element on board. They provide the advantage of optimizing die area and cost for higher current applications but suffer the disadvantage of being a multiple package solution.

If we graph the efficiency of the different classes of linear regulators we see very significant differences at low input and output voltages (see Figure 1-4). At higher voltages, however, these differences diminish. A 3.3V high current linear regulator controller such as the Micrel MIC5156 can approach 100% efficiency as the input voltage approaches dropout. But an LM317 set to 3.3V at 1A will have a miserable efficiency of only about 50% at its dropout threshold.

Linear Regulators versus Switching Regulators

Linear regulators are less energy efficient than switching regulators. Why do we continue using them? Depending upon the application, linear regulators have several redeeming features:

- lower output noise is important for radios and other communications equipment
- faster response to input and output transients
- easier to use because they require only filter capacitors for operation
- generally smaller in size (no magnetics required)
- less expensive (simpler internal circuitry and no magnetics required)

Furthermore, in applications using low input-to-output voltage differentials, the efficiency is not all that bad! For example, in a 5V to 3.3V microprocessor application, linear regulator efficiency approaches 66%. And applications with low current subcircuits may not care that regulator efficiency is less than optimum as the power lost may be negligible overall.

Who Prefers Linear Low Dropout Regulators?

We see that price sensitive applications prefer linear regulators over their sampled-time counterparts. The design decision is especially clear cut for makers of:

- communications equipment
- small devices
- battery operated systems
- low current devices
- high performance microprocessors with sleep mode (fast transient recovery required)

As you proceed through this book, you will find numerous other applications where the linear regulator is the best power supply solution.

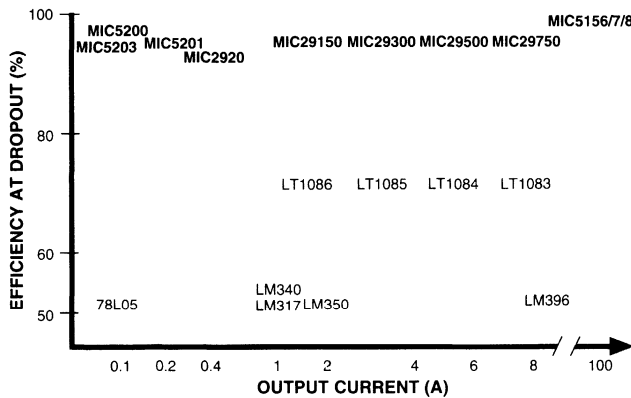

Figure 1-4. Linear Regulator Efficiency at Dropout

Section 2. Low Dropout Regulator Design Charts

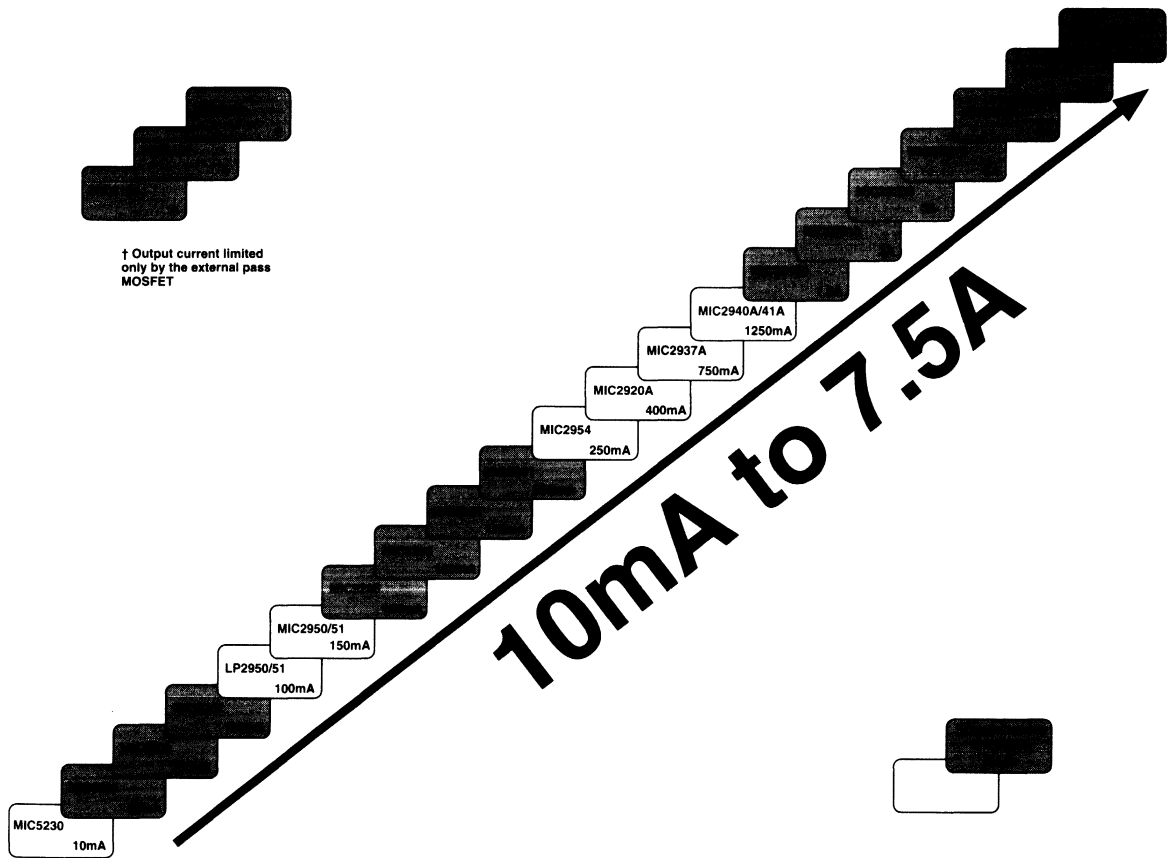

Figure 2-1. Micrel's Low Dropout Linear Regulators.

Micrel's low-dropout linear regulators are available with maximum rated output currents ranging from 10mA to 7.5A (monolithics); the MIC5156/5157/5158 "Super LDO" controller has no inherent maximum current. Regulators shown inside a shaded box feature

"zero-current" shutdown mode, and draw virtually no current when the regulator is disabled. The charts on the next few pages are designed to help you choose a regulator with the necessary output capability, thermal rating, and feature set.

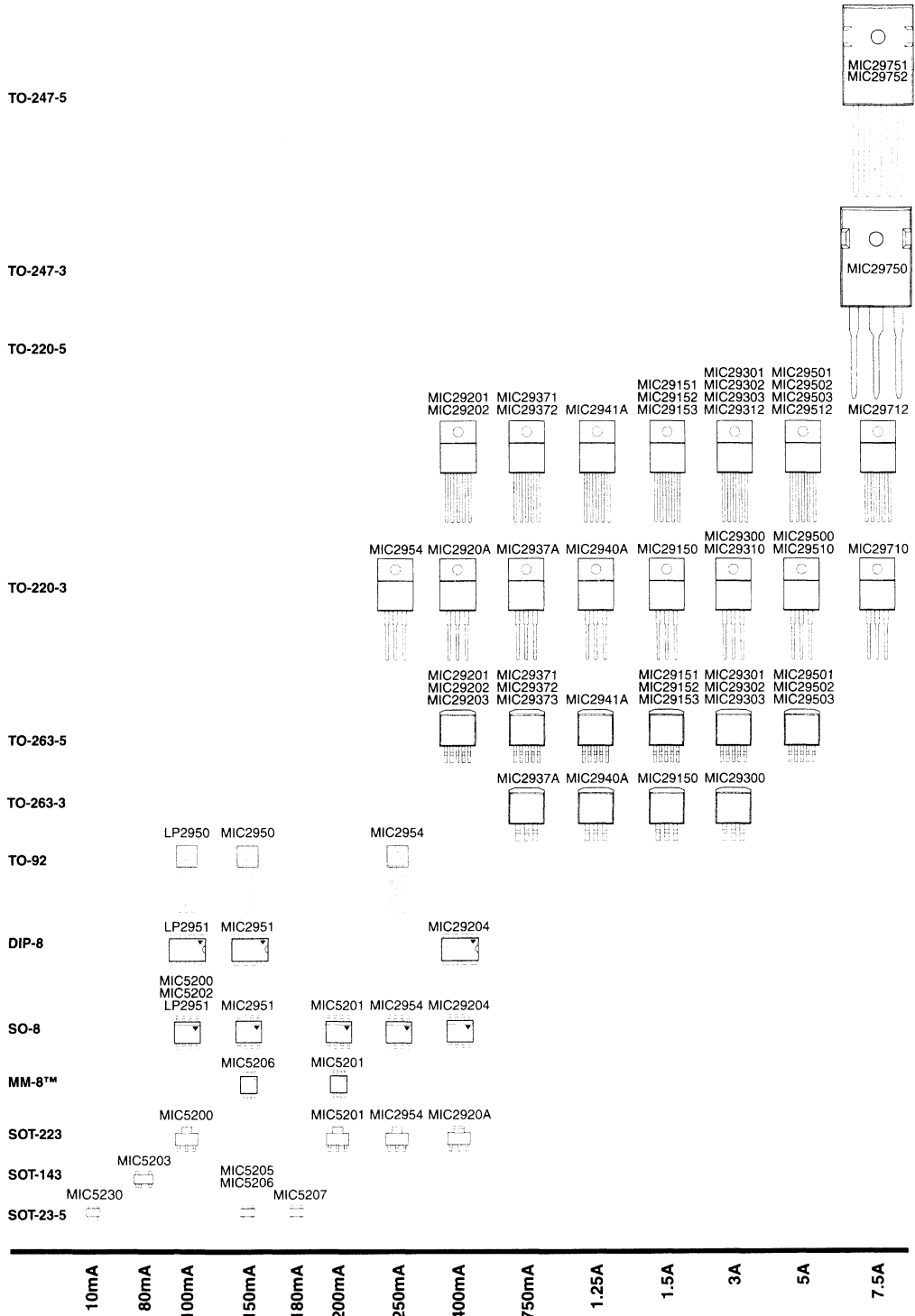

Figure 2-2. Output Current & Package Type Selector Guide

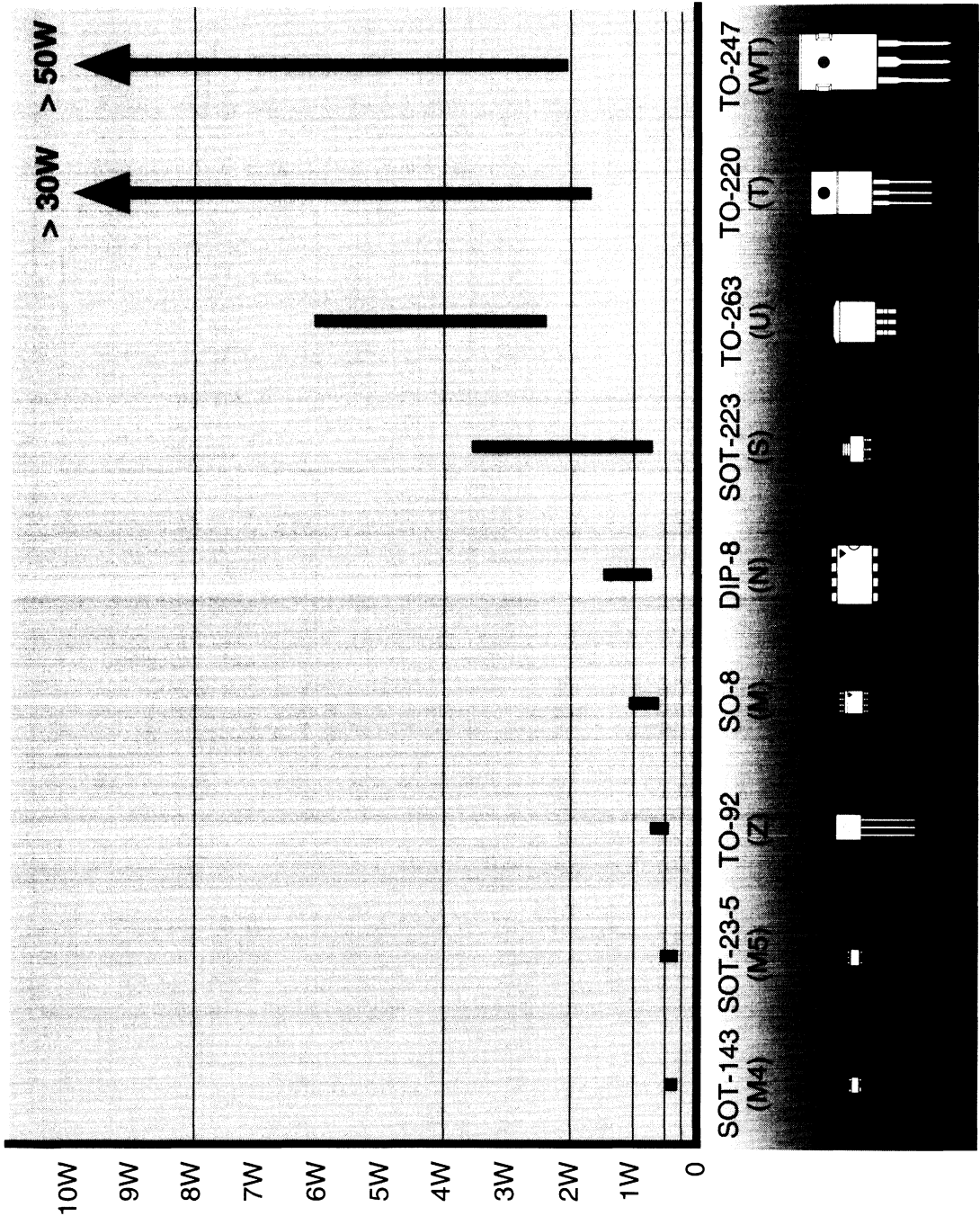

Figure 2-3 Maximum Power Dissipation by Package Type

The minimum point on each line of Figure 2-3 shows package power dissipation capability using “worst case” mounting techniques. The maximum point shows power capability with a very good (not infinite, though) heat sink. For example, through-hole TO-220 packages can dissipate a bit less than 2W without a heat sink, and over 30W with a good sink. The chart is approximate, and assumes an ambient temperature of 25°C. Packages are *not* shown in their approximate relative size.

Table 2-1 LDO Selector Guide



Device	V _{OUT}				Accuracy	I _{OUT} (mA)	Dropout Voltage @ I _{LM} (Max. @ 25°C)	Features					Package		
	3.0	3.3	5.0	12				Adjust.	I _{LM}	Therm Protect	Error Flag	Logic Control		Reverse Supply	Load Dump
MIC5203	•	•	•	•		80	450mV	•	•	•	•	•	•	•	SOT-143
MIC5200	•	•	•	•		100	450mV	•	•	•	•	•	•	•	SO-8, SOT-223
MIC5202	•	•	•	•		100 dual	450mV	•	•	•	•	•	•	•	SO-8
LP2950						100	450mV	•	•						TO-92
LP2951					1.2 to 29		450mV @ 100mA	•	•	•	•	•	•	•	P DIP, SO-8
MIC2950						150	300mV @ 100mA	•	•	•	•	•	•	•	TO-92
MIC2951	•	•	•	•	1.2 to 29		300mV @ 100mA	•	•	•	•	•	•	•	P DIP, SO-8
MIC5205	•	•	•	•	1.2 to 16	150	275mV	•	•	•	•	•	•	•	SOT-23-5
MIC5206	•	•	•	•	1.2 to 16	150	275mV	•	•	•	•	•	•	•	SOT-23-5, MM8™
MIC5207	•	•	•	•	1.2 to 16	180	300mV	•	•	•	•	•	•	•	SOT-23-5
MIC5201	•	•	•	•	1.2 to 16	200	450mV	•	•	•	•	•	•	•	SO-8, SOT-223, MM8™
MIC2954					1.2 to 29	250	500mV @ 250mA	•	•	•	•	•	•	•	TO-92, TO-220
MIC2920A						400	450mV	•	•	•	•	•	•	•	SOT-223, SO-8
MIC29201	•	•	•	•			450mV @ 250mA	•	•	•	•	•	•	•	TO-220, SOT-223
MIC29202	•	•	•	•	1.2 to 26		370mV typ.	•	•	•	•	•	•	•	TO-220-5, TO-263-5
MIC29204					1.2 to 26			•	•	•	•	•	•	•	TO-220-5, TO-263-5
MIC2937A						750	450mV @ 500mA	•	•	•	•	•	•	•	P DIP, SO-8
MIC29371							325mV typ	•	•	•	•	•	•	•	TO-220, TO-263
MIC29372					1.2 to 26			•	•	•	•	•	•	•	TO-220-5, TO-263-5
MIC2940A						1250	450mV	•	•	•	•	•	•	•	TO-220, TO-263
MIC2941A					1.2 to 26			•	•	•	•	•	•	•	TO-220-5, TO-263-5

▲ = 4.85V, ● = 3.6V, 3.8V, 4.0V, 4.75V; ■ = 3.6V, 3.8V, 4.0V

LDO Selector Guide

Device	V _{OUT}			Accuracy	I _{OUT} (A)	Dropout Voltage @ I _{OUT} (Max. @ 25°C)	I _{LIM}	Features					Package		
	3.0	3.3	see note 5.0					12	Adjust.	Therm Protect	Error Flag	Logic Control		Reverse Supply	Load Dump
MIC29150	•	•	•	•	1% 1.5A	450mV	•	•	•	•	•	•	•	•	TO-220, TO-263
MIC29151	•	•	•	•	1% 1.5A	450mV	•	•	•	•	•	•	•	•	TO-220, TO-263
MIC29152	•	•	•	•	1% 1.5A	450mV	•	•	•	•	•	•	•	•	TO-220, TO-263
MIC29300	•	•	•	•	1% 3A	450mV	•	•	•	•	•	•	•	•	TO-220, TO-263
MIC29301	•	•	•	•	1% 3A	450mV	•	•	•	•	•	•	•	•	TO-220, TO-263
MIC29302	•	•	•	•	1% 3A	450mV	•	•	•	•	•	•	•	•	TO-220, TO-263
MIC29303	•	•	•	•	1% 3A	450mV	•	•	•	•	•	•	•	•	TO-220, TO-263
MIC29310	•	•	•	•	3A	1V	•	•	•	•	•	•	•	•	TO-220
MIC29312	•	•	•	•	3A	1V	•	•	•	•	•	•	•	•	TO-220
MIC29500	•	•	•	•	1% 5A	450mV	•	•	•	•	•	•	•	•	TO-220
MIC29501	•	•	•	•	1% 5A	450mV	•	•	•	•	•	•	•	•	TO-220, TO-263
MIC29502	•	•	•	•	1% 5A	450mV	•	•	•	•	•	•	•	•	TO-220, TO-263
MIC29503	•	•	•	•	1% 5A	450mV	•	•	•	•	•	•	•	•	TO-220, TO-263
MIC29510	•	•	•	•	5A	1V	•	•	•	•	•	•	•	•	TO-220
MIC29512	•	•	•	•	5A	1V	•	•	•	•	•	•	•	•	TO-220
MIC29710	•	•	•	•	7.5A	1V	•	•	•	•	•	•	•	•	TO-220
MIC29712	•	•	•	•	7.5A	1V	•	•	•	•	•	•	•	•	TO-220
MIC29750	•	•	•	•	1% 7.5A	450mV	•	•	•	•	•	•	•	•	TO-247
MIC29751	•	•	•	•	1% 7.5A	450mV	•	•	•	•	•	•	•	•	TO-247
MIC29752	•	•	•	•	1% 7.5A	450mV	•	•	•	•	•	•	•	•	TO-247
MIC5156	•	•	•	•	1%	①	•	•	•	•	•	•	•	•	SOIC, P DIP, CerDIP ① Max. I _{OUT} and dropout determined by choice of external MOSFET ② Selectable: 3.3V/5V/12V ③ Selectable: 5V/adjustable
MIC5157	•	•	•	•	1%	①	•	•	•	•	•	•	•	•	
MIC5158	•	•	•	•	1%	①	•	•	•	•	•	•	•	•	

▲ = 4.85; ● = 3.6V, 3.8V, 4.0V, 4.75V; ■ = 3.6V, 3.8V, 4.0V

Figure 2-4. A Pictorial Guide to Choosing Linear Regulators

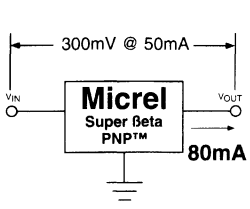

MIC5203

- Guaranteed 80mA output
- 3.0V, 3.3V, 3.6V, 3.8V, 4.0V, 4.75V, and 5.0V fixed
- 300mV typical dropout at 50mA
- Super Beta PNP™ minimizes ground current
- Available in SOT-143 package

MIC5203

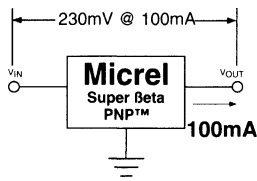
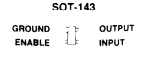

MIC5200/5202

- Guaranteed 100mA output
- 3.0V, 3.3V, and 5.0V fixed
- 230mV typical dropout at 100mA
- Super Beta PNP™ minimizes ground current
- MIC5200 Single is available in SO-8 and SOT-223 packages
- MIC5202 dual is available in SO-8

MIC5200

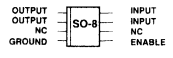

MIC5202

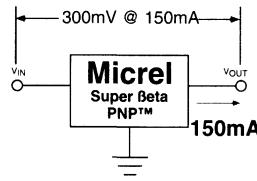
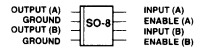

MIC2950

- Guaranteed 150mA output
- 3.3V, 4.85V, 5.0V fixed or adjustable
- 300mV typical dropout at 150mA
- Super Beta PNP™ minimizes ground current
- Available in SO-8, DIP, and TO-92 packages

MIC2950



MIC2951

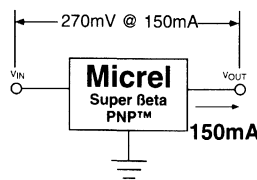
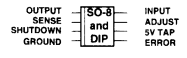

MIC5205

- Guaranteed 150mA output
- 3.0V, 3.3V, 3.6V, 3.8V, 4.0V, 5.0V or adj.
- 165mV typical dropout at 150mA
- Ultralow noise
- Super Beta PNP™ minimizes ground current
- Available in SOT-23-5 package

MIC5205

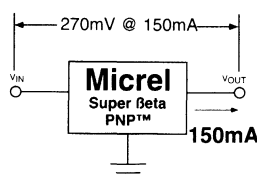
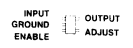

MIC5206

- Guaranteed 150mA output
- 3.0V, 3.3V, 3.6V, 3.8V, 4.0V, 5.0V or adj.
- 165mV typical dropout at 150mA
- Low noise/ultralow noise
- Fault flag output
- Super Beta PNP™ minimizes ground current
- Available in SOT-23-5 and SO-8 packages

MIC5206

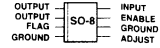
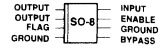
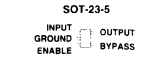

MIC5207

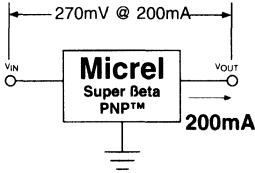

- Guaranteed 150mA output
- 3.0V, 3.3V, 3.6V, 3.8V, 4.0V, 5.0V or adj.
- 300mV maximum dropout at 150mA
- Ultralow noise
- Super Beta PNP™ minimizes ground current
- Available in SOT-23-5 package

MIC5207

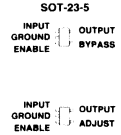

MIC5201

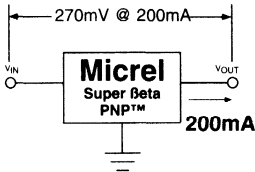

- Guaranteed 200mA output
- 3.0V, 3.3V, 4.5V, 5.0V, or adjustable
- 270mV typical dropout at 200mA
- Super Beta PNP™ minimizes ground current
- Available in SO-8 and SOT-223 packages

MIC5201

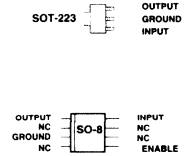

MIC2954

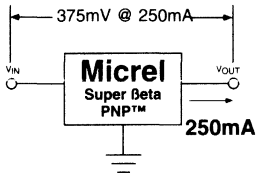

- Guaranteed 250mA output
- 5.0V fixed or adjustable
- <450mV dropout at 250mA
- Super Beta PNP™ minimizes ground current
- Available in SO-8, SOT-223, TO-220, and TO-92 packages

MIC2954

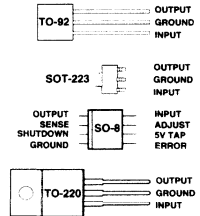

MIC2920A

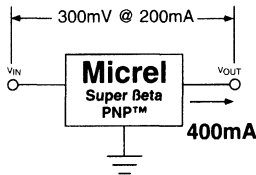

- Guaranteed 400mA output
- 3.3V, 5V, 12V fixed or adjustable
- 450mV typical dropout at 400mA
- Super Beta PNP™ minimizes ground current
- Available in SO-8, DIP, TO-220, TO-263, and SOT-223 packages

MIC2920A

MIC29201

MIC29202

MIC29204

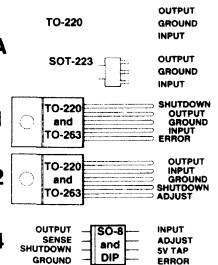

MIC2937A

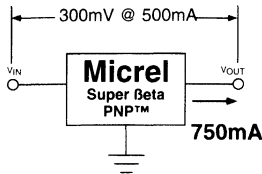

- Guaranteed 750mA output
- 3.3V, 5V, 12V fixed or adjustable
- 370mV typical dropout at 750mA
- Super Beta PNP™ minimizes ground current
- Available in TO-220 and TO-263 packages

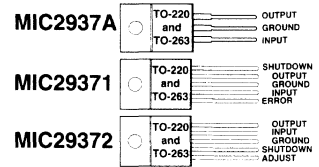

MIC2940A

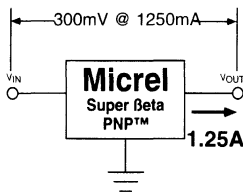

- Guaranteed 1250mA output
- 3.3V, 5V, 12V fixed or adjustable
- 300mV typical dropout at 1.25A
- Super Beta PNP™ minimizes ground current
- Available in TO-220 and TO-263 packages

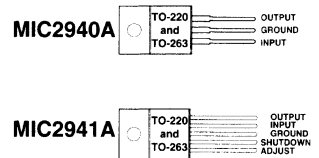

MIC29150

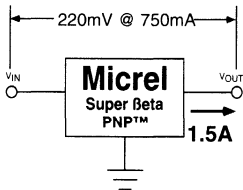

- Guaranteed 1.5A output
- 3.3V, 5V, 12V fixed or adjustable
- <450mV dropout at 1.5A
- Zero power shutdown mode
- Super Beta PNP™ minimizes ground current
- Available in TO-220 and TO-263 packages

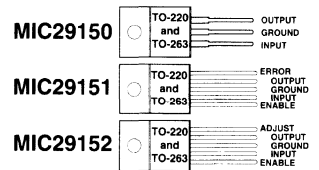

MIC29300

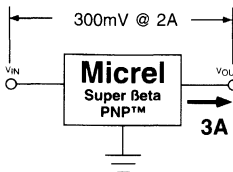

- Guaranteed 3A output
- 3.3V, 5V, 12V fixed or adjustable
- Input range to 26V
- 370mV typical dropout at 3A
- Zero power shutdown mode
- Super Beta PNP™ minimizes ground current
- Available in TO-220 and TO-263 packages

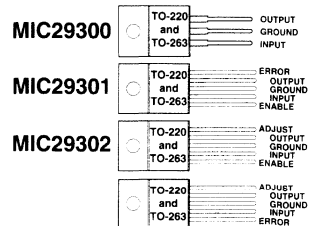

MIC29310

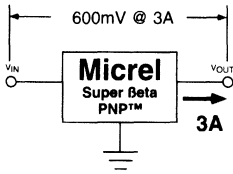

- Guaranteed 3A output
- 3.3V, 5V fixed or adjustable
- 600mV typical dropout at 3A
- Zero power shutdown mode
- Input range to 16V
- Available in TO-220-3 and -5 packages

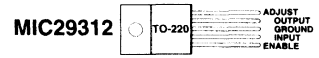
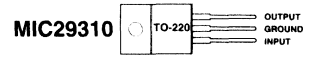

MIC29500

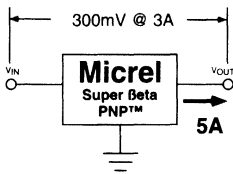

- Guaranteed 5A output
- 3.3V, 5V fixed or adjustable
- Input range to 26V
- 370mV typical dropout at 5A
- Zero power shutdown mode
- Super Beta PNP™ minimizes ground current
- Available in TO-220 and TO-263 packages

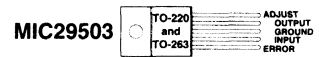
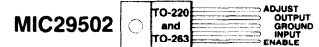
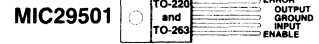
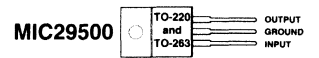

MIC29510

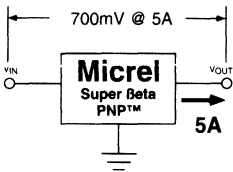

- Guaranteed 5A output
- 3.3V, 5V fixed or adjustable
- 700mV typical dropout at 5A
- Zero power shutdown mode
- Input range to 16V
- Available in TO-220-3 and -5 packages

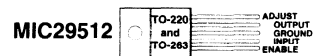
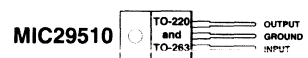

MIC29710

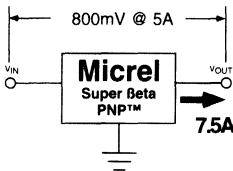

- Guaranteed 7.5A output
- 3.3V and 5V fixed or adjustable
- 700mV typical dropout at 7.5A
- Zero power shutdown mode
- Input range to 16V
- Available in TO-220-3 and -5 packages

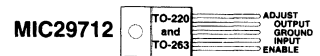
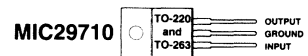

MIC29750

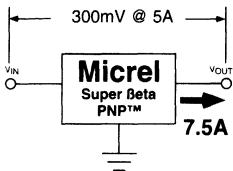

- Guaranteed 7.5A output
- 3.3V, 5V fixed or adjustable
- 240mV typical dropout at 7.5A
- Zero power shutdown mode
- Super Beta PNP™ minimizes ground current

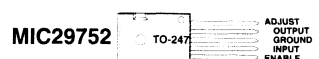
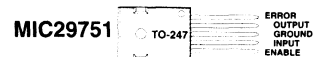

Pin Compatible Selector Guide

Figure 2-5

Many Micrel regulators have the same pinout across different output current ratings. Choosing a regulator in one of these pin-compatible series allows you the flexibility to migrate up (or down) in current capacity, if necessary, without changing your circuit board layout. Only *exact* matches are shown in this selector guide and regulators with “unique” packages or pinouts do not appear.

Through-Hole Devices

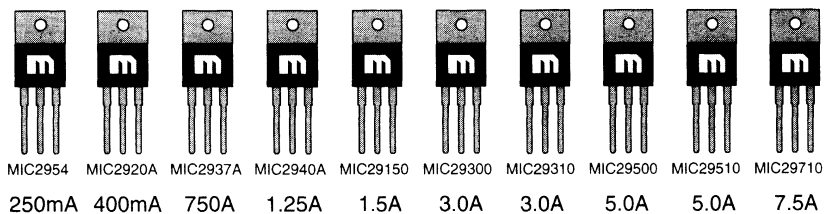
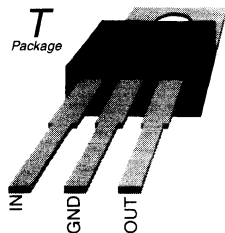
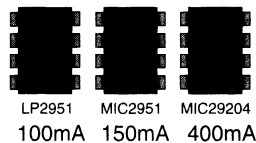
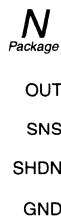
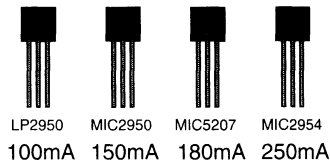

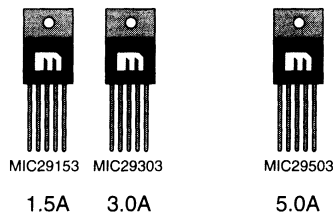
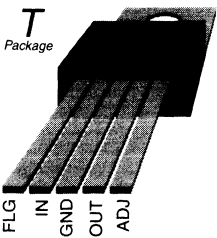
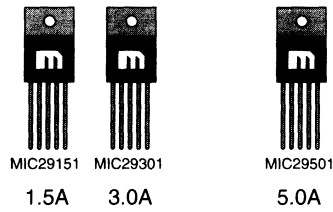
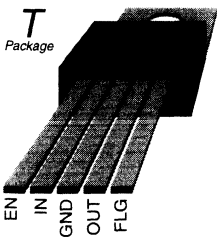
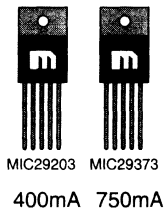
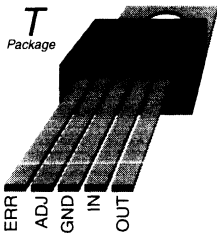
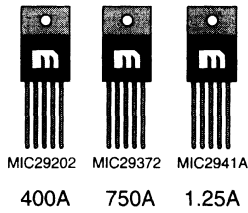
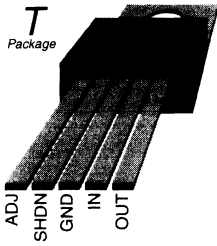
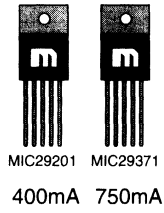
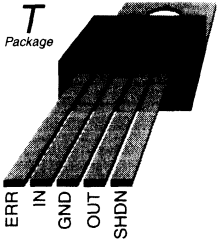

Surface Mount Devices

M

Package



LP2951	MIC2951	MIC2954	MIC29204
100mA	150mA	250mA	400mA

S

Package



MIC5200	MIC5201	MIC2954	MIC2920A
100mA	200mA	250mA	400mA

U

Package



MIC2937A	MIC2940A	MIC29150	MIC29300	MIC29500
750mA	1.25A	1.5A	3.0A	5.0A

U

Package



MIC29202	MIC29372	MIC2941A
400A	750A	1.25A

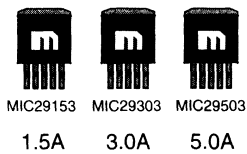
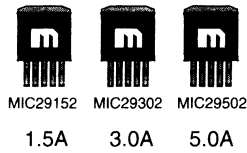
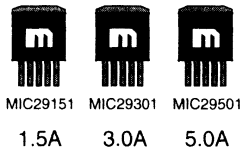
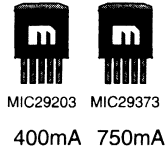

Table 2-2. Typical Thermal Characteristics

Device	θ_{JC}	θ_{CS}	"Typical" heat sink θ_{JA}	Equivalent Thermal Graph
MIC5203BM4	—	—	250	A
MIC5200BM	—	—	160	B
MIC5200BS	15	—	50	E
MIC5202BM	—	—	160	B
LP2950BZ	—	—	160 – 180	B
LP2951BM	—	—	160	B
MIC2950BZ	—	—	160 – 180	D
MIC2951BM	—	—	160	D
MIC2951BN	—	—	105	
MIC5205BM5	—	—	220	C
MIC5206BM5	—	—	220	C
MIC5206BMM	—	—	200	C
MIC5207BM5	—	—	220	C
MIC5201BM	—	—	160	D
MIC5201BS	15	—	50	E
MIC2954BM	—	—	160	
MIC2954BS	15	—	50	
MIC2954BT	3	1	15 – 30	
MIC2954BZ	—	—	160 – 180	
MIC2920ABS	15	—	50	
MIC2920ABT	3	1	15 – 30	G
MIC29202BU	3	—	30 – 50	F
MIC29203BU	3	—	30 – 50	F
MIC29204BM	—	—	160	
MIC2937ABT	3	1	15 – 30	G
MIC2937ABU	3	—	30 – 50	G
MIC29371BT	3	1	15 – 30	G
MIC29371BU	3	—	30 – 50	G
MIC29372BT	3	1	15 – 30	G
MIC29372BU	3	—	30 – 50	G
MIC29373BT	3	1	15 – 30	G
MIC29373BU	3	—	30 – 50	G
MIC2940ABT	3	1	15 – 30	H
MIC2940ABU	3	—	30 – 50	
MIC2941BT	2	1	15 – 30	H
MIC2941BU	2	—	30 – 50	
MIC29150BT	2	1	10 – 30	H
MIC29150BU	2	—	30 – 40	
MIC29151BT	2	1	10 – 30	H
MIC29151BU	2	—	30 – 40	
MIC29152BT	2	1	10 – 30	H
MIC29152BU	2	—	30 – 40	
MIC29153BT	2	1	10 – 30	H
MIC29153BU	2	—	30 – 40	
MIC29300BT	2	1	10 – 30	I
MIC29300BU	2	—	30 – 40	
MIC29301BT	2	1	10 – 30	I
MIC29301BU	2	—	30 – 40	
MIC29302BT	2	1	10 – 30	I
MIC29302BU	2	—	30 – 40	
MIC29303BT	2	1	10 – 30	I
MIC29303BU	2	—	30 – 40	
MIC29310BT	2	1	10 – 30	I
MIC29312BT	2	1	10 – 30	I
MIC29500BT	2	1	5 – 15	J
MIC29500BU	2	—	20 – 30	
MIC29501BT	2	1	5 – 15	J
MIC29501BU	2	—	20 – 30	
MIC29502BT	2	1	5 – 15	J
MIC29502BU	2	—	20 – 30	
MIC29503BT	2	1	5 – 15	J
MIC29503BU	2	—	20 – 30	
MIC29510BT	2	1	5 – 15	J
MIC29512BT	2	1	5 – 15	J
MIC29710BT	2	1	5 – 15	K
MIC29712BT	2	1	5 – 15	K
MIC29750BWT	1.5	0.5	3 – 9	L
MIC29751BWT	1.5	0.5	3 – 9	L
MIC29752BWT	1.5	0.5	3 – 9	L

Output Current vs. Junction Temperature and Voltage Differential

(Figure 2-6)

These graphs show the junction temperature with a given output current and input–output voltage differential. Ambient temperature is 25°C. The assumed thermal resistance is shown under each graph. Refer to *Thermal Management*, in **Section 3**, for definitions and details.

For example, a MIC5203-3.3BM4, supplying 50mA and with 5.3V on its input ($V_{IN} - V_{OUT} = 3V$), will have a junction temperature of approximately 63° (Figure 2-6 (A)).

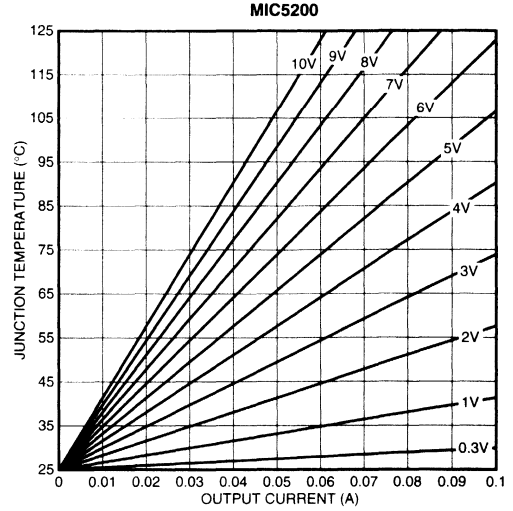

Figure 2-6 (B). SO-8 with $\theta_{JA} = 160^{\circ}C/W$

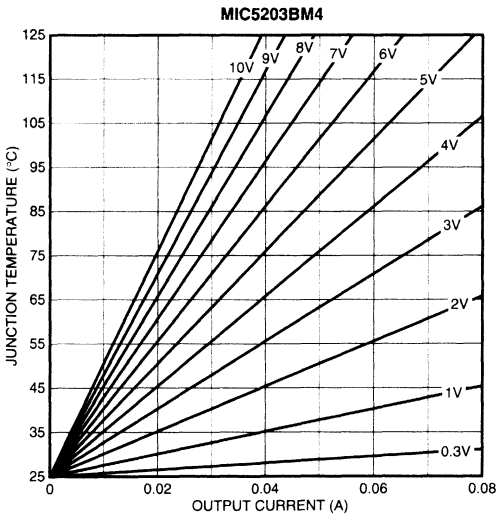

Figure 2-6 (A). SOT-143 with $\theta_{JA} = 250^{\circ}C/W$

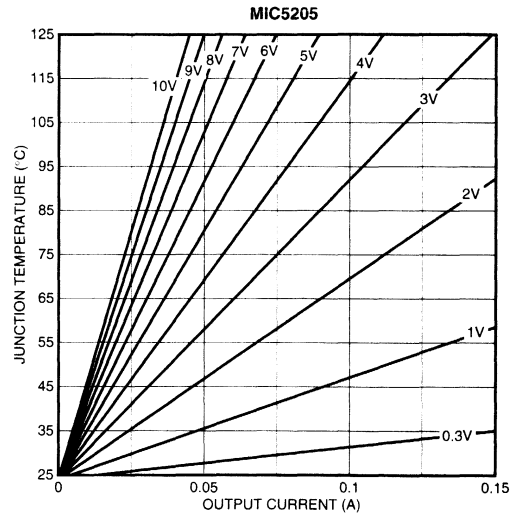

Figure 2-6 (C). SOT-23-5 with $\theta_{JA} = 220^{\circ}C/W$

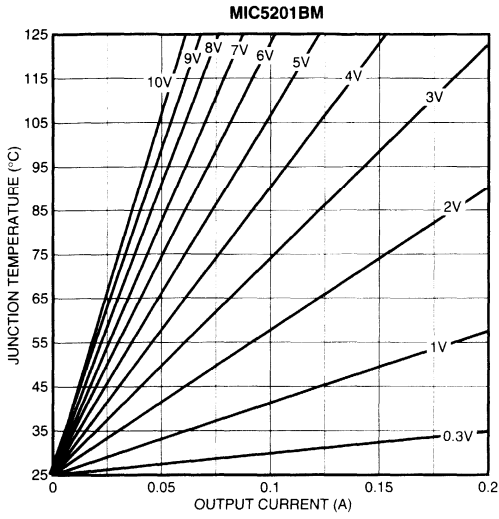

Figure 2-6 (D). High Current SO-8 with $\theta_{JA} = 160^{\circ}\text{C/W}$

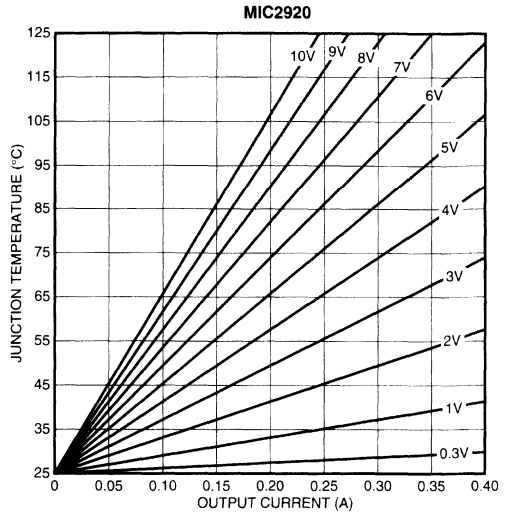

Figure 2-6 (F). TO-263 with $\theta_{JA} = 40^{\circ}\text{C/W}$

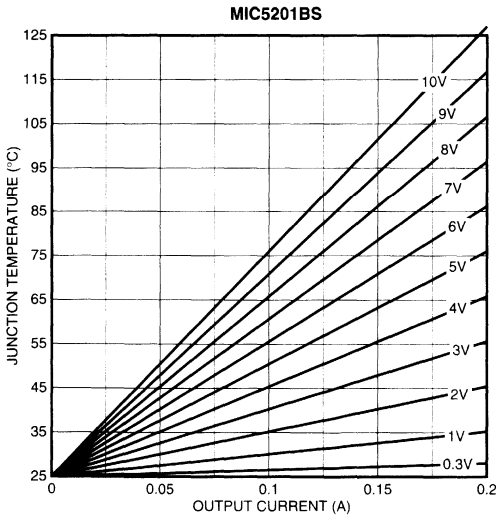

Figure 2-6 (E). SOT-223 with $\theta_{JA} = 50^{\circ}\text{C/W}$

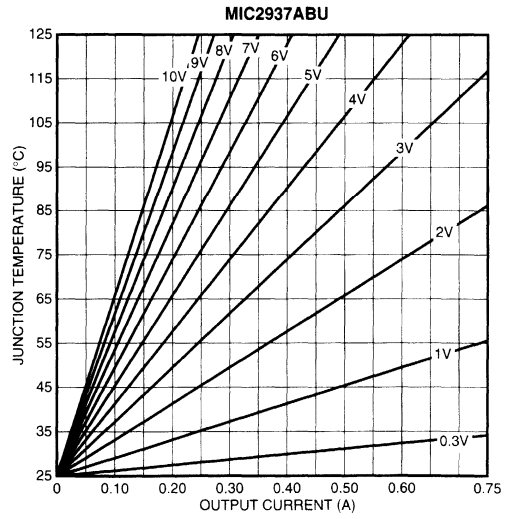

Figure 2-6 (G). TO-263 with $\theta_{JA} = 40^{\circ}\text{C/W}$

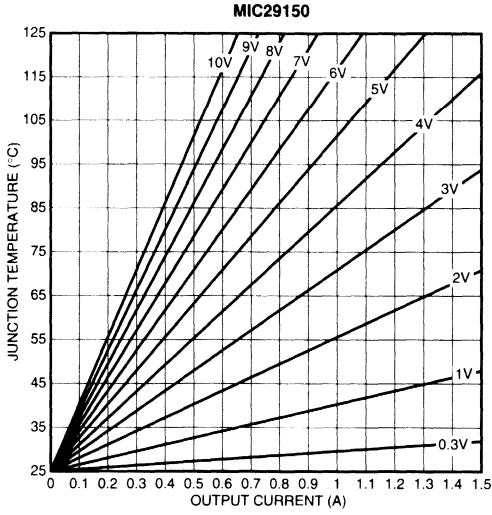

Figure 2-6 (H). TO-220 with $\theta_{JA} = 15^{\circ}\text{C/W}$

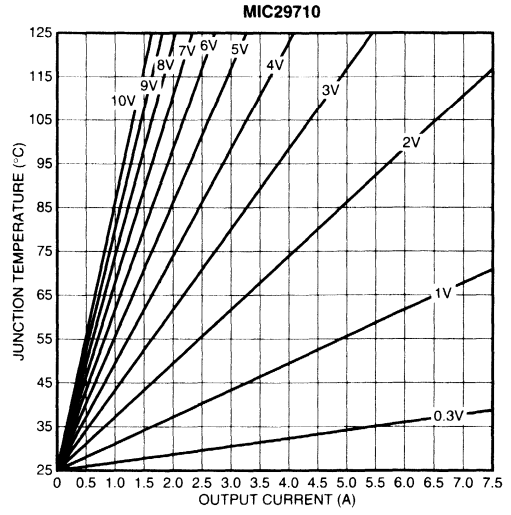

Figure 2-6 (K). TO-220 with $\theta_{JA} = 6^{\circ}\text{C/W}$

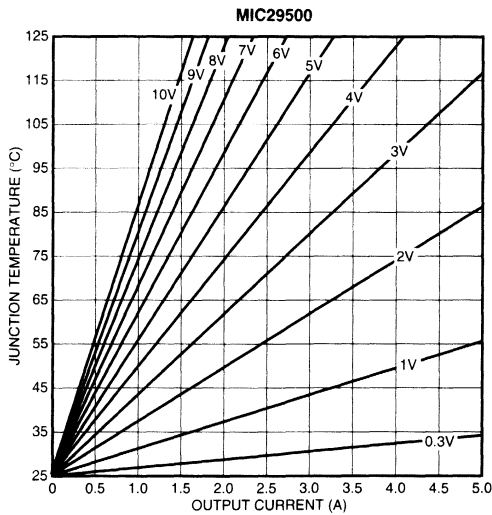

Figure 2-6 (J). TO-220 with $\theta_{JA} = 6^{\circ}\text{C/W}$

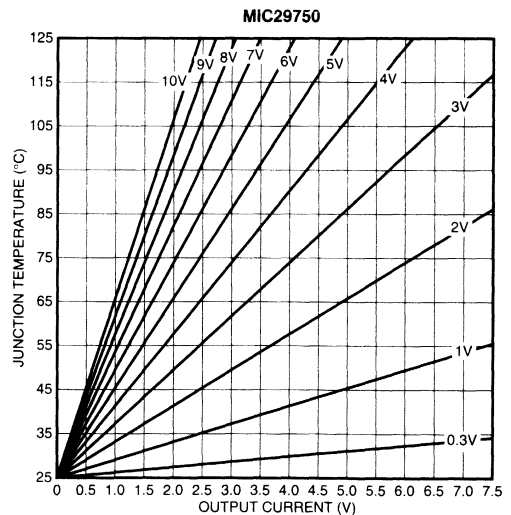

Figure 2-6 (L). TO-247 with $\theta_{JA} = 4^{\circ}\text{C/W}$

Junction Temperature Rise vs. Available Output Current and Differential Voltage

(Figure 2-7)

These graphs show the available thermally-limited steady-state output current with a given thermal resistance and input—output voltage differential. The assumed θ_{JA} (thermal resistance from junction to ambient) is shown below each graph. Refer to *Thermal Management* in **Section 3** for definitions and details.

For example, Figure 2-7 (C) shows that the MIC5205BM5, with 3V across it ($V_{IN} = V_{OUT} + 3V$) and supplying 120mA, will have a temperature rise of 90°C (when mounted normally).

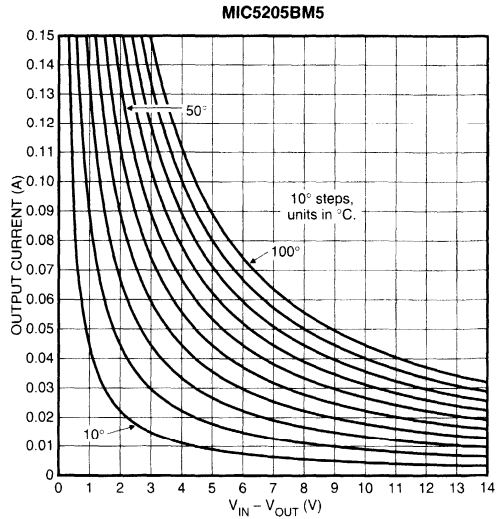

Figure 2-7 (C). SOT-23-5 with $\theta_{JA} = 220^\circ\text{C/W}$

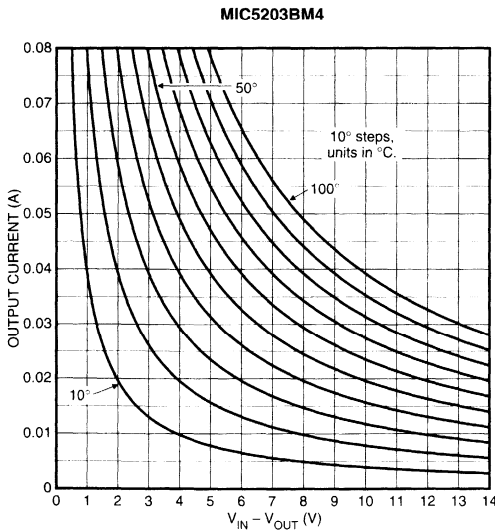

Figure 2-7 (A). SOT-143 with $\theta_{JA} = 250^\circ\text{C/W}$

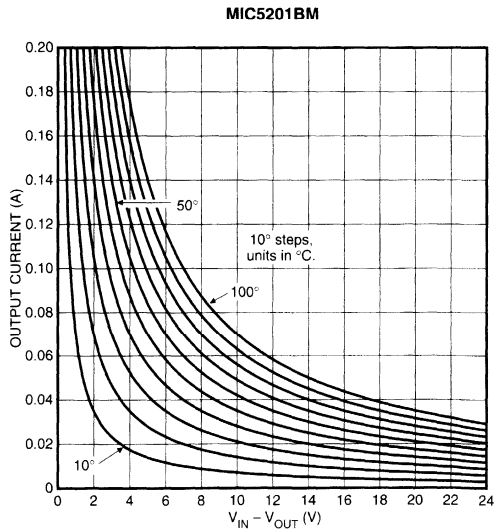

Figure 2-7 (D). SO-8 with $\theta_{JA} = 140^\circ\text{C/W}$

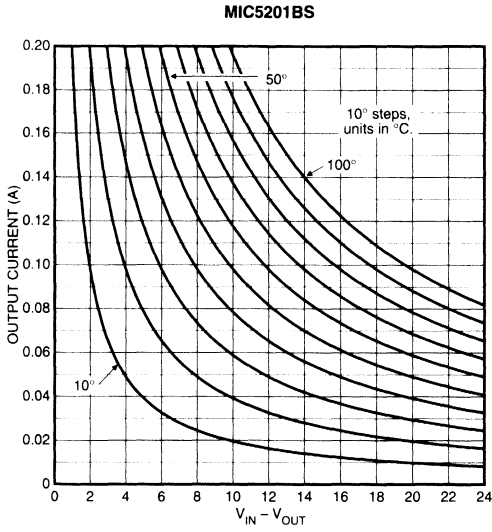

Figure 2-7 (E). SOT-223 with $\theta_{JA} = 50^{\circ}\text{C/W}$

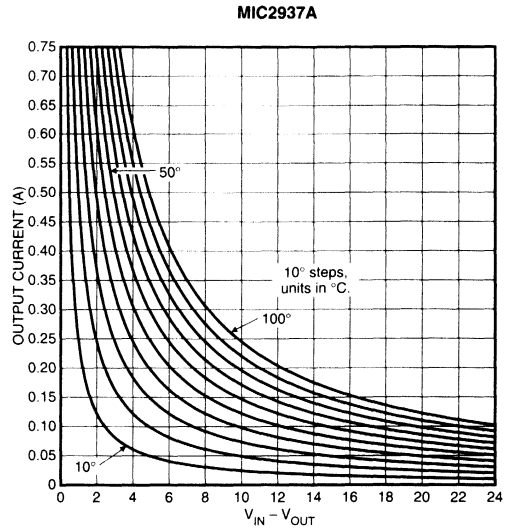

Figure 2-7 (G). TO-263 with $\theta_{JA} = 40^{\circ}\text{C/W}$

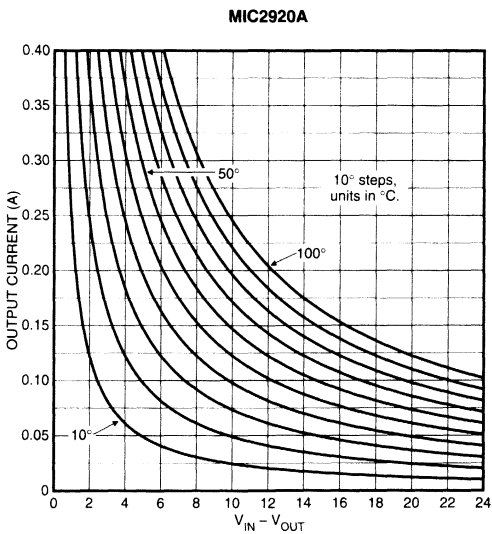

Figure 2-7 (F). TO-263 with $\theta_{JA} = 40^{\circ}\text{C/W}$

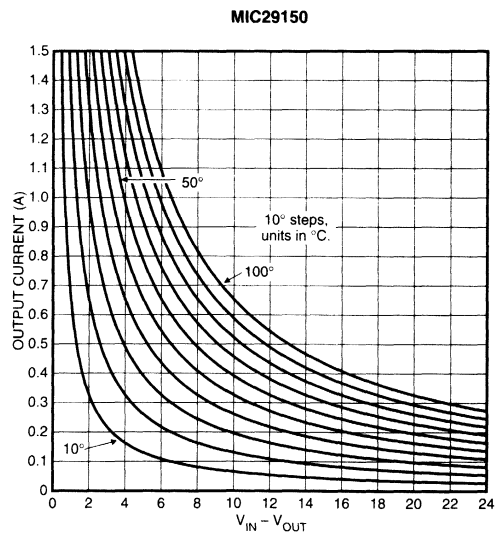

Figure 2-7 (H). TO-220 with $\theta_{JA} = 15^{\circ}\text{C/W}$

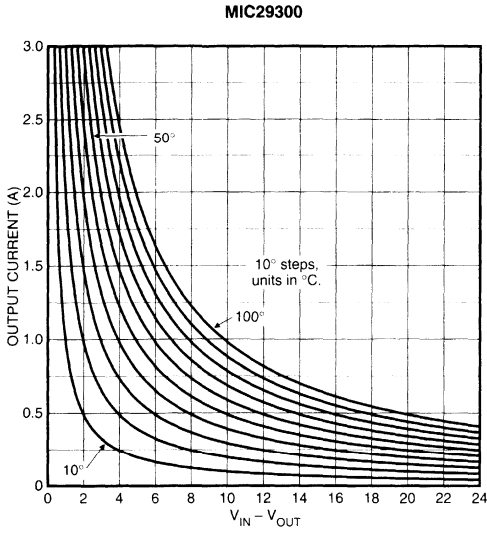

Figure 2-7 (I). TO-220 with $\theta_{JA} = 10^{\circ}\text{C}/\text{W}$

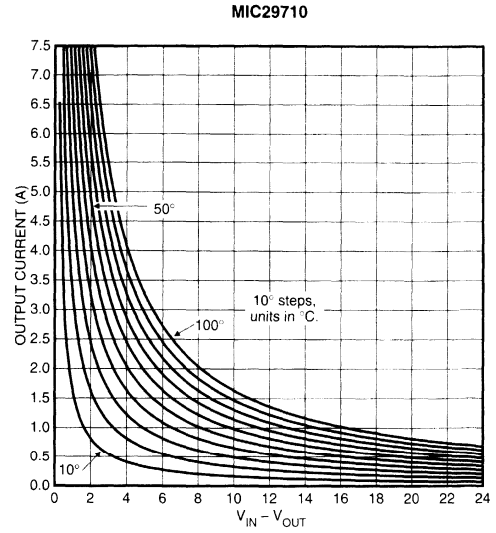

Figure 2-7 (K). TO-220 with $\theta_{JA} = 6^{\circ}\text{C}/\text{W}$

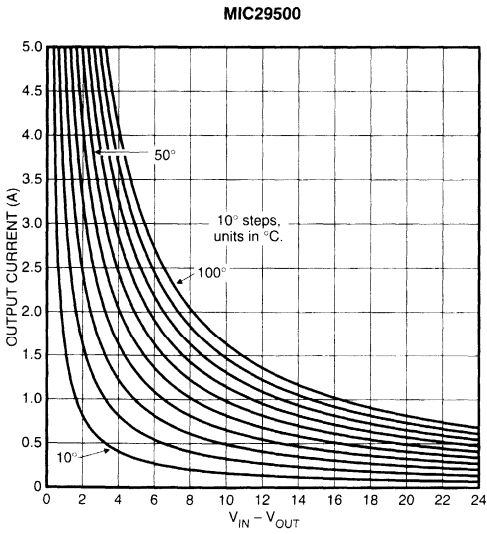

Figure 2-7 (J). TO-220 with $\theta_{JA} = 6^{\circ}\text{C}/\text{W}$

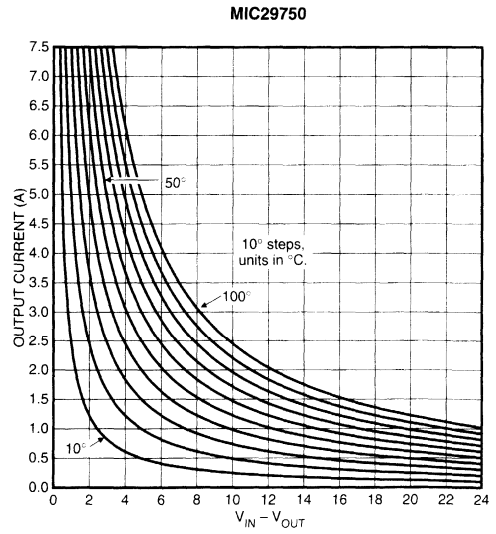

Figure 2-7 (L). TO-247 with $\theta_{JA} = 4^{\circ}\text{C}/\text{W}$

Section 3. Using LDO Linear Regulators

General Layout and Construction Considerations

Layout

Although often considered “just a D.C. Circuit”, low-dropout linear regulators are actually built with moderately high frequency transistors because rapid response to input voltage or output current changes demand excellent high frequency performance. These characteristics place some requirements on bypass capacitors and board layout.

Bypass Capacitors

Low-dropout linear regulators need capacitors on both their input and output. The input capacitor provides bypassing of the internal op amp used in the voltage regulation loop. The output capacitor improves regulator response to sudden load changes, and in the case of the Super β PNP™ devices, provides loop compensation that allows stable operation.

The input capacitor for monolithic regulators should feature low inductance and generally good high frequency performance. Capacitance is not too critical except for systems where excessive input ripple voltage is present. The capacitor must, as a minimum, maintain the input voltage minimum value above the dropout point. Otherwise, the regulator ceases regulation and becomes merely a saturated switch. In an AC-line powered system, where the regulator is mounted within a few centimeters from the main filter capacitor, additional capacitors are often unnecessary. A 0.1 μ F ceramic directly adjacent to the regulator is always a good choice, however. If the regulator is farther away from the filter capacitor, local bypassing is mandatory.

With the high current MIC5157 and MIC5158 Super LDO™ regulator controllers, the input capacitor should be a medium sized (10 μ F or larger) low ESR (effective series resistance) type.

Output Capacitor

The Super β PNP regulators require a certain minimum value of output capacitance for operation—below this minimum value, the output may exhibit oscillation. The output capacitor is inside the voltage control loop and is necessary for loop stabilization. Minimum recommended values are listed on each device data sheet. There is *no* maximum value—the output capacitor may be increased without limit.¹

Excellent response to high frequency load changes (load current transient recovery) demands low inductance, low ESR, high frequency filter capacitors. Stringent requirements are solved by paralleling multiple medium sized capacitors. Capacitors should be chosen by comparing their lead inductance, ESR, and dissipation factor. Multiple small or medium sized capacitors provide better high frequency characteristics than a single capacitor of the same total capacity since the lead inductance and ESR of the multiple capacitors is reduced by paralleling.

Although the capacitance value of the filter may be increased without limit, if the ESR of the paralleled capacitors drops below a certain (device family dependent) threshold, a zero in the transfer plot appears, lowering phase margin and decreasing stability. With some devices, especially the MIC5157 and MIC5158 Super LDO, this problem is solved by using a low ESR input decoupling capacitor. Worst-case situations may require changes to higher ESR output capacitors—perhaps increasing both the ESR and the capacitance by using a different chemistry—or, as a last resort, by adding a small series resistance ($< 1\Omega$) between the regulator and the capacitor(s).

NOTE 1: Truly huge output capacitors will extend the start-up time, since the regulator must charge them. This time is determined by capacitor value and the current limit value of the regulator.

Circuit Board Layout

Stray capacitance and inductance may upset loop compensation and promote instability. Excessive input lead resistance increases the dropout voltage, and excessive output lead resistance reduces output load regulation. Ground loops also cause both problems. Careful layout is the solution.

Reduce stray capacitance and inductance by placing bypass and filter capacitors close to the regulator. Swamp parasitic reactances by using a 0.1µF ceramic capacitor (or equivalent) in parallel with the regulator input filter capacitor. Designers of battery-powered circuits often overlook the finite high-frequency impedance of their cells. The ceramic capacitor solves many unexpected problems.

Excessive lead resistance, causing unwanted voltage drops and ruining load regulation, is solved by merely increasing conductor size. Regulators with remote sensing capability—like all Micrel adjustables—may utilize a Kelvin-sense connection directly to the load. As Figure 3-1 shows, an additional pair of wires feeds back the load voltage to the regulator sense input.² This lets the regulator compensate for line drop. As the Kelvin sense leads carry only the small voltage-programming resistor current, they may be very narrow traces or small diameter wire. A judicious layout is especially important in remote-sensed designs, since these long, high impedance leads are susceptible to noise pickup.

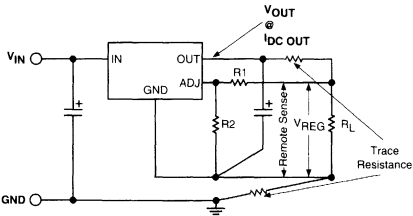

Figure 3-1. Remote Voltage Sense (Kelvin) Connections

A common ground loop problem occurs when rectifier ripple current flows through the regulator's

NOTE 2: The internal reference in most Micrel regulators is positioned between the adjust pin and ground, unlike the older "classic" NPN regulator designs. This technique, while providing excellent performance with Micrel regulators, does not work with the older voltage regulators; in fact, it reduces their output voltage accuracy.

ground lead on its way to the filter capacitor (see Figure 3-2). The ripple current, which is several times larger than the average DC current, may create a voltage drop in the ground line, raising its voltage relative to the load. As the regulator attempts to compensate, load regulation suffers. Solve the problem by ensuring rectifier current flows directly into the filter capacitor.

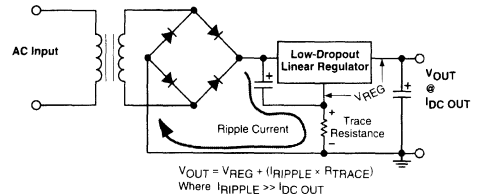

Figure 3-2. Ground Loop and Ripple Currents Degrade Output Accuracy

Figure 3-3 shows an ideal layout for remote-sensed loads. If a single point ground is not practical, load regulation is improved by employing a large ground plane.

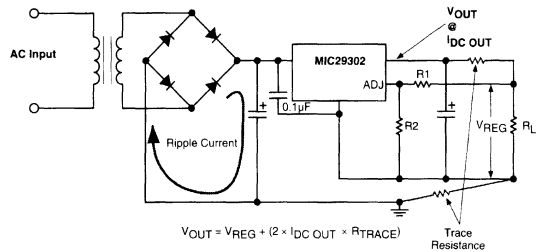

Figure 3-3. Regulator Layout With Remote Voltage Sensing

Assembly

Low power regulator circuits are built like any other analog system. Surface mounted systems are assembled using normal reflow (or similar), techniques. Larger leaded packages may require special lead bending before installation; specific lead bend options are available from Micrel, or the assembler may bend them. When power demands force the use of a heat sink, extra care must be applied during assembly and soldering. Our assembly discussion will focus on the popular TO-220 package but it is generally applicable to other package types.

Lead Bending

If lead bending is necessary, use the standard bend options offered by Micrel whenever possible. These bending operations are performed on tooling developed specifically for this purpose and with the safety of the package, die, and internal wire bonds in mind. Custom lead bending is also available for a nominal charge.

For prototyping or other low quantity custom lead bending requirements, clamp the leads at the junction of the case with long nosed pliers. Using your fingers or another pair of pliers, bend the outer lead as desired. Please observe the following cautions:

- Do not spread or compress the leads
- Do not bend or twist the leads at the body junction: start the bend at least 3mm from the body
- Maintain a lead bend radius of approximately 1mm
- Do not re-bend leads multiple times

Micrel TO-220 packages are made from nickel-plated or tinned copper for best electrical and thermal performance. While rugged electrically, they are susceptible to mechanical stress and fatigue. Please handle them with care!

Heat Sink Attachment

TO-220 package applications at moderate (room) temperatures may not require heat sinking if the power dissipation is less than 2 watts. Otherwise, heat sinks are necessary. Use the minimum practical lead length so heat may travel more directly to the board, and use the board itself as a heat sink.

Attachment techniques vary depending upon the heat sink type, which in turn depends upon the power dissipated. The first consideration is whether or not electrical isolation is required. Micrel's Super Beta PNP regulators all have a grounded tab, which usually means no insulation is necessary. This helps by reducing or eliminating one of the thermal resistances. Next, we determine heat sink size. See the *Thermal Management* chapter for details. If a standard commercial heat sink is chosen, we may generally assume minimal surface roughness or burrs.

Otherwise, machining the mounting pad may be necessary to achieve a flatness (peak-to-valley) of 4

mils per inch with a surface finish of $\pm 1.5\mu\text{m}$ or better for minimum thermal resistance.

Holes for the mounting screw should be drilled and deburred. Slightly oversized holes allow for slippage during temperature cycling and is generally recommended.

Heat sinks of bare aluminum or copper are not optimum heat radiators. Anodizing or painting improves heat radiation capability. For more details on heat sinks, see the *References*.

Thermal grease, thermal pads, or other thermally conductive interface between the package and the heat sink compensates for surface flatness errors, mounting torque reduction over time, air gaps, and other sins, and is recommended. Heat sink manufacturers offer a variety of solutions with widely varying prices, installation ease, and effectiveness.

Many heat sinks are available with mounting clips. These allow fast assembly and, when the clip also presses against the plastic body instead of only the metal tab, provide excellent heat contact area and low thermal resistance.

Machine screws are often used for heat sink attachment (see Figure 3-4). Proper torque is imperative; too loose and the thermal interface resistance is excessive; too tight and the semiconductor die will crack. The 0.68N-m specification applies to clean threads; ensure that the thermal grease does not interfere with the threads.

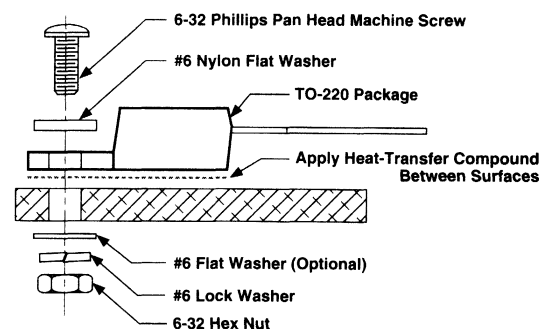

Maximum Torque: 0.68 N-m (6 in-lbs)
 (Caution: Excessive torque may crack semiconductor)

Figure 3-4. Mounting TO-220 Packages to Heat Sinks

Output Voltage Accuracy

Adjustable Regulator Accuracy Analysis

Micrel LDO Regulators are high accuracy devices with output voltages factory-trimmed to much better than 1% accuracy. Across the operating temperature, input voltage, and load current ranges, their worst-case accuracies are still better than ±2%. For adjustable regulators, the output also depends upon the accuracy of two programming resistors. Some systems require supply voltage accuracies better than ±2.5%—including noise and transients. While noise is generally not a major contributor to output inaccuracy, load transients caused by rapidly varying loads (such as high-speed microprocessors), are significant, even when using fast transient-response LDO regulators and high-quality filter capacitors.

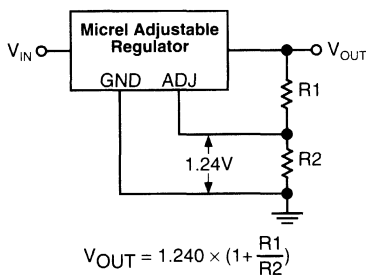

Figure 3-5. An adjustable linear regulator uses the ratio of two resistors to determine its output voltage.

Adjustable regulators use the ratio of two resistors to multiply the reference voltage to produce the desired output voltage (see Figure 3-5). The formula for output voltage from two resistors is presented as Equation 3-1.

$$(3-1) \quad V_{OUT} = V_{REF} \left(1 + \frac{R1}{R2}\right)$$

The basic MIC29512 has a production-trimmed reference (V_{REF}) with better than ±1% accuracy at a fixed temperature of 25°C. It is guaranteed better than ±2% over the full operating temperature range, input voltage variations, and load current changes. Since practical circuits experience large temperature swings we should use the ±2% specification as our theoretical worst-case. This value assumes no error contribution from the programming resistors.

Referring to Figure 3-5 and Equation 3-1, we see that resistor tolerance (tol) must be added to the

reference tolerance to determine the total regulator inaccuracy. A sensitivity analysis of this equation shows that the error contribution of the adjust resistors is:

$$(3-2) \quad \text{Error Contribution \%} = \left(\frac{2 \times \text{tol\%}}{1 - \left(\frac{\text{tol\%}}{100}\right)} \right) \times \left(1 - \frac{V_{REF}}{V_{OUT}} \right)$$

Since the output voltage is proportional to the product of the reference voltage and the ratio of the programming resistors, at high output voltage, the error contribution of the programming resistors is the sum of each resistor's tolerance. Two standard ±1% resistors contribute as much as 2% to output voltage error. At lower voltages, the error is less significant. Figure 3-6 shows the effects of resistor tolerance on regulator accuracy from the minimum output voltage (V_{REF}) to 12V. At the minimum V_{OUT} , theoretical resistor tolerance has no effect on output accuracy. Resistor error increases proportionally with output voltage: at an output of 2.5V, the sensitivity factor is 0.5; at 5V it is about 0.75; and at 12V it is over 0.9. This means that with 5V of output, the error contribution of 1% resistors is 0.75 times the sum of the tolerances, or $0.75 \times 2\% = 1.5\%$. As expected, more precise resistors offer more accurate performance.

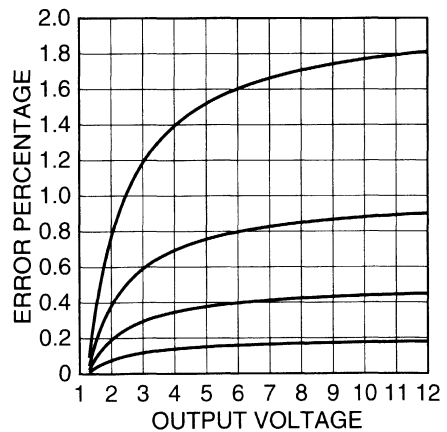

Figure 3-6. Resistor Tolerance Effects on Adjustable Regulator Accuracy

The output voltage error of the entire regulator system is the sum of reference tolerance and the resistor error contribution. Figure 3-7 shows this worst-case tolerance for the MIC29512 as the output voltage varies from minimum to 12V using ±1%, ±0.5%,

±0.25%, and ±0.1% resistors. The more expensive, tighter accuracy resistors provide improved tolerance, but it is still limited by the adjustable regulator's ±2% internal reference.

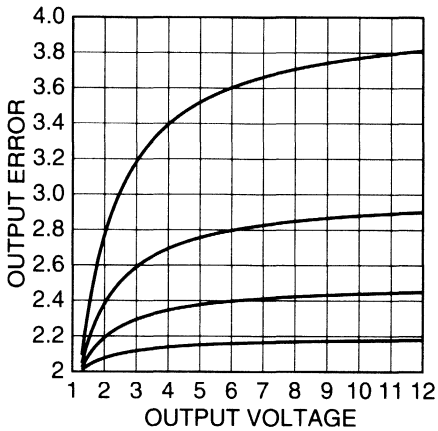

Figure 3-7. Worst-Case Output Tolerance.

A better method is possible: increase the overall accuracy of the regulator by employing a precision reference in the feedback loop.

Improving Regulator Accuracy

Achieving a worst-case error of ±2.5%, including all D/C and A/C error terms, is possible by increasing the basic accuracy of the regulator itself, but this is expensive since high current regulators have significant self-heating. Its internal reference must maintain accuracy across a wide temperature range. Testing for this level of performance is time consuming and raises the cost of the regulator, which is unacceptable for extremely price-sensitive marketplaces. Some systems require better than ±2% accuracy. This high degree of accuracy is possible using Micrel's LM4041 voltage reference instead of one of the programming resistors (refer to Figure 3-8). The regulator output voltage is the sum of the internal reference and the LM4041's programmed voltage (Equation 3-3).

$$(3-3) \quad V_{OUT} = V_{REF \text{ Regulator}} + V_{LM4041} \\ = 1.240 + V_{LM4041}$$

The benefit of this circuit is the increased accuracy possible by eliminating the multiplicative effect

of the regulator's internal reference. In normal configurations, the reference error is multiplied up by the resistor ratio, keeping the error percentage constant. With this circuit, the error voltage is within 25mV, absolute. Another benefit of this arrangement is that the LM4041 is not a dissipative device: there is only a small internal temperature rise to degrade accuracy. Additionally, both references are operating in their low-sensitivity range so we get less error contribution from the resistors. A drawback of this configuration is that the minimum output voltage is now the sum of both references, or about 2.5V. The adjustable LM4041 is available in accuracies of ±0.5% and ±1%, which allows better overall system output voltage accuracy.

Equation 3-4 presents the formula for the LM4041-ADJ output voltage. Note the output voltage has a slight effect on the reference. Refer to the LM4040 data sheet for full details regarding this second-order coefficient.

$$(3-4) \quad V_{LM4041} = \left[V_{OUT} \times \frac{\Delta V_{REF}}{\Delta V_{OUT}} + 1.233 \right] \times \left[\frac{R1b}{R1a} + 1 \right]$$

Actually, the voltage drop across R1b is slightly higher than that calculated from Equation 3-4. Approximately 60nA of current flows out of the LM4041 FB terminal. With large values of R1b, this current creates millivolts of higher output voltage; for best accuracy, compensate R1b by reducing its size accordingly. This error is +1mV with R1b = 16.5kΩ.

Equation 3-5 shows the nominal output voltage for the composite regulator of Figure 4.

$$(3-5) \quad V_{OUT} = \frac{1.233 \left(\frac{R1b}{R1a} + 1 \right)}{1.013 + \left(\frac{0.0013R1b}{R1a} \right)} + (60nA \times R1b) + 1.40V$$

Note that the tolerance of R2 has no effect on output voltage accuracy. It sets the diode reverse (operating) current and also allows the divider current from R1a and R1b to pass. With R2 = 1.2kΩ, 1mA of bias flows. If R2 is too small (less than about 105Ω, the maximum reverse current of the LM4041-ADJ is exceeded. If it is too large with respect to R1a and R1b then the circuit will not regulate. The recommended range for R2 is from 121Ω to $R1a / 10$.

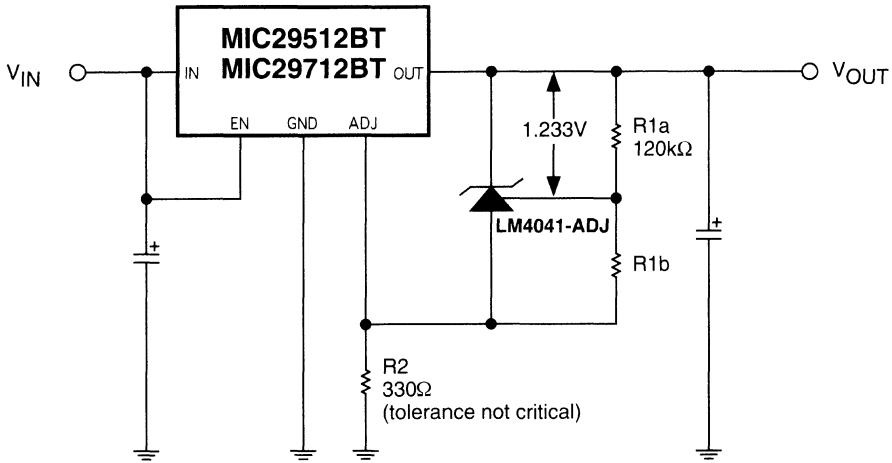

Figure 3-8. Improved Accuracy Composite Regulator Circuit

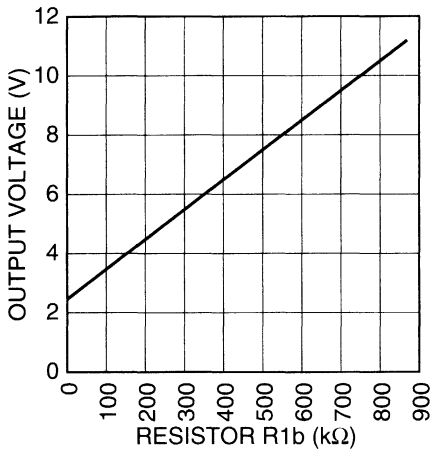

Figure 3-9. Output Voltage vs. R1b (See Figure 3-8)

Regulator & Reference Circuit Performance

With this circuit we achieve much improved accuracies. Our error terms are:

- 25mV (constant) from the MIC29512
- 0.5% from the LM4041C
- + 0 to 2% from R1a and R1b
- 0.5% + 25mV to 2.5% + 25mV** Total Error budget

Figure 3-10 shows the resistor error contribution to the LM4041C reference output voltage tolerance. Figure 3-11 shows the worst-case output voltage error of the composite regulator circuit using various resistor tolerances, when a 0.5% LM4041C reference is employed. The top four traces reflect use of 1%, 0.5%, 0.25%, and 0.1% resistors. Table 3-1 lists the production accuracy obtained with the low-cost LM4041C and standard 1% resistors as well as the improvement possible with 0.1% resistors.

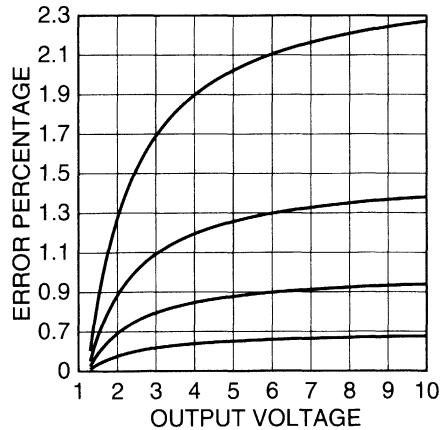

Figure 3-10. Resistor Tolerance Effects on LM4041 Voltage Reference Accuracy.

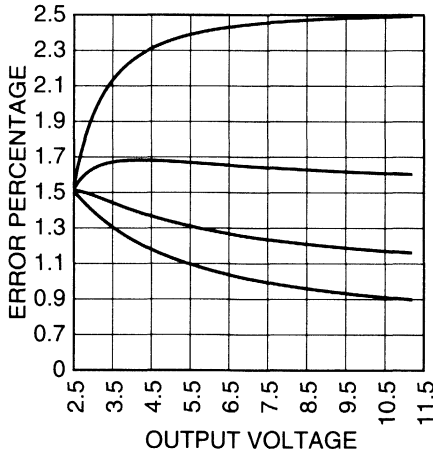

Figure 3-11. Composite Regulator Accuracy.

What does the extra complexity of the composite regulator circuit of Figure 3-8 buy us in terms of extra accuracy? With precision components, we may achieve tolerances better than $\pm 1\%$ with the composite regulator, as compared to a theoretical best case of somewhat worse than 2% with the standard regulator and resistor configuration. Figure 3-12 and Table

3-2 show the accuracy difference between the circuits as the output voltage changes. The accuracy difference is the tolerance of the two-resistor circuit minus the tolerance of the composite circuit. Both tolerances are the calculated worst-case value, using 1% resistors. This figure shows the composite circuit is always at least 1% better than the standard configuration. Both the figure and the table assume standard $\pm 1\%$ resistors and the LM4041C-ADJ (0.5%) reference.

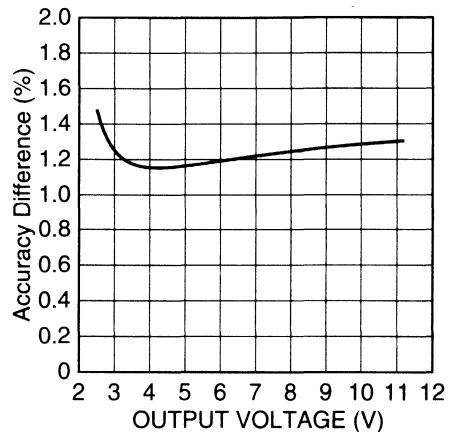

Figure 3-12. Accuracy difference between the standard two-resistor circuit and the composite circuit of Figure 3-8.

V _{OUT}	1% Resistors	0.1% Resistors
2.50V	$\pm 1.54\%$	$\pm 1.50\%$
2.90V	$\pm 1.88\%$	$\pm 1.41\%$
3.00V	$\pm 1.94\%$	$\pm 1.39\%$
3.30V	$\pm 2.07\%$	$\pm 1.34\%$
3.45V	$\pm 2.12\%$	$\pm 1.31\%$
3.525V	$\pm 2.14\%$	$\pm 1.30\%$
3.60V	$\pm 2.16\%$	$\pm 1.29\%$
5.00V	$\pm 2.36\%$	$\pm 1.13\%$
6.00V	$\pm 2.41\%$	$\pm 1.07\%$
8.00V	$\pm 2.46\%$	$\pm 0.98\%$
10.00V	$\pm 2.49\%$	$\pm 0.92\%$
11.00V	$\pm 2.49\%$	$\pm 0.90\%$

Table 3-1. Worst-case output voltage error for typical operating voltages

V _{OUT}	Composite Circuit	Standard Circuit
2.50V	$\pm 1.6\%$	$\pm 3.0\%$
3.00V	$\pm 1.9\%$	$\pm 3.2\%$
3.30V	$\pm 2.1\%$	$\pm 3.3\%$
3.50V	$\pm 2.1\%$	$\pm 3.2\%$
5.00V	$\pm 2.4\%$	$\pm 3.5\%$
6.00V	$\pm 2.4\%$	$\pm 3.6\%$
8.00V	$\pm 2.5\%$	$\pm 3.7\%$
10.00V	$\pm 2.5\%$	$\pm 3.8\%$
11.00V	$\pm 2.5\%$	$\pm 3.8\%$

Table 3-2. Comparing the worst-case output voltage error for the two topologies with typical output voltages.

Design Issues and General Applications

Noise and Noise Reduction

Most of the output noise caused by a LDO regulator emanates from the voltage reference. While some of this noise may be shunted to ground by the output filter capacitor, bypassing the reference at a high impedance node provides more attenuation for a given capacitor value. The MIC5205 and MIC5206 use a lower noise bandgap reference and also provide external access to this reference. A small value (470pF or so) external capacitor attenuates output noise by about 10dB for a 5 volt output.

All of Micrel’s adjustable regulators allow a similar technique. By shunting one of the voltage programming resistors with a small-value capacitor, the high frequency gain of the regulator is reduced which serves to reduce high frequency noise. The capacitor should be placed across the resistor connecting between the feedback pin and the output (R1 on data sheet schematics).

Stability

Low dropout linear regulators with a PNP output require an output capacitor for stable operation. See *Stability Issues* in **Section 4, Linear Regulator Solutions** for a discussion on stability with Super beta PNP regulators.

The Super LDO is more stable than the monolithic devices and rarely needs much attention to guarantee stability. *Micrel’s Unique “Super LDO”*, also in Section 4, discusses the few parameters requiring vigilance.

LDO Efficiency

The electrical efficiency of all electronic devices is defined as $P_{OUT} \div P_{IN}$. A close efficiency approximation for linear regulators is

$$Eff = \frac{V_{OUT}}{V_{IN}}$$

This approximation neglects regulator operating current, but is very accurate (usually within 1%) for Super beta PNP and Super LDO regulators with their

very low housekeeping power draw. The full formula is:

$$Eff = \frac{V_{IN} \times (I_{GND}) + (V_{IN} - V_{OUT}) \times I_{OUT}}{V_{OUT} \times I_{OUT}}$$

Building an Adjustable Regulator Allowing 0V Output

Some power supplies, especially laboratory power supplies and power systems demanding well-controlled surge-free start-up characteristics, require a zero-volt output capability. In other words, an adjustable laboratory power supply should provide a range than includes 0V. However, as shown in Figure 3-13, a typical adjustable regulator does not facilitate adjustment to voltages lower than V_{REF} (the internal bandgap voltage). Adjustable regulator ICs are designed for output voltages ranging from their reference voltage to their maximum input voltage (minus dropout); the reference voltage is generally about 1.2V. The lowest output voltage available from this circuit is provided when $R1 = 0\Omega$. For the MIC29152 LDO regulator, $V_{REF} = 1.240V$, so $V_{OUT(min)} = V_{REF}(1+R1/R2)$, or 1.240V.

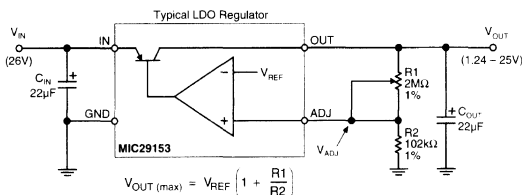

Figure 3-13. Typical Adjustable Regulator

Two designs work around the minimum output voltage limitation. The first uses a low-cost reference diode to create a “virtual” V_{OUT} that cancels the reference. The second uses op-amps to convince the regulator adjust pin that zero volts is a proper output level. In both cases, the feedback-loop summing junction must be biased at V_{REF} to provide linear operation.

Reference Generates a “Virtual V_{OUT} ”

Figure 3-14 shows a simple method of achieving a variable output laboratory supply or a less-than-1.2V fixed-output supply. The circuit uses a second bandgap reference to translate the regulator’s output up to a “virtual V_{OUT} ” and then uses that virtual V_{OUT} as the top of a feedback divider. The output voltage adjusts from 0V to about 20V.

When R1 goes to 0Ω, the output is about 0V, the virtual V_{OUT} is one bandgap voltage above ground, and the adjust input is also one bandgap voltage above ground. The regulator's error amplifier loop is satisfied that both of its inputs are at one bandgap voltage and it keeps the output voltage constant at 0V. The virtual V_{OUT} tracks any increases in R1, remaining one bandgap voltage above the actual V_{OUT} , as the output rises from ground. The maximum possible V_{OUT} equals the regulator's maximum input voltage minus the approximately 2V housekeeping voltage required by the current-source FET and the external bandgap reference.

The current source, composed of a 2N3687 JFET and R3, is designed for about 77μA. Seven microamperes for the resistor string (about 100 times the nominal 60nA input current of the regulator's adjust input) and 70μA for the bandgap. R2 is optional, and is needed only if no load is present. It bleeds off the 70μA of reference current and satisfies the minimum load current requirement of the regulator.

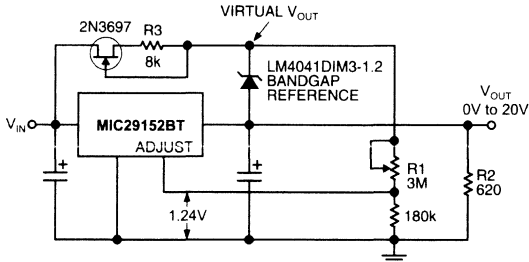

Figure 3-14. Adjust to Zero Volt Circuit Using a Reference Diode

A drawback of this simple design is that the voltage of the internal reference in the regulator must match the external (LM4041) voltage for the output to actually reach zero volts. In practice, the minimum output voltage from this simple circuit is a few millivolts.

Op-Amp Drives Ground Reference

The circuit of Figure 3-15 provides adjustability down to 0V by controlling the ground reference of the feedback divider. It uses the regulator's internal bandgap reference to provide both accuracy and economy. Non-inverting amplifier A2 senses V_{REF} (via V_{ADJ}) and provides a gain of just slightly more than unity. When R5 is adjusted to supply ground to voltage follower A1 then ground is also applied to the

bottom of feedback voltage divider R1 and R2, and operation is identical to the standard adjustable regulator configuration, shown in Figure 1 (when adjusted to provide maximum output voltage). Conversely, when R5 is adjusted so the input to voltage follower A1 is taken directly from the output of amplifier A2 the bottom of voltage divider R1 and R2 is biased such that V_{ADJ} will equal V_{REF} when V_{OUT} is 0V. Rotation of R5 results in a smooth variation of output voltage from 0V to the upper design value, which is determined by R1 and R2.

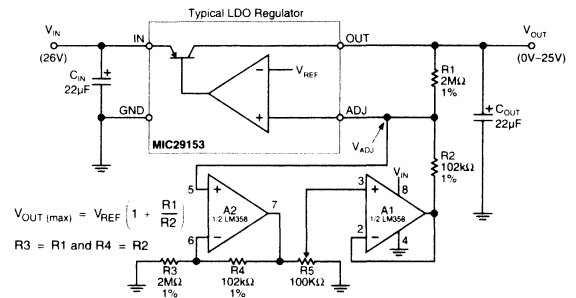

Figure 3-15. 0V-to-25V Adjustable Regulator

The gain of amplifier A2 is $1 + R4 / R3 = 1.05$, in this example. Note that the portion of gain above unity is the reciprocal of the attenuation ratio afforded by feedback divider R1 and R2; i.e., $R4 / R3 = 1 / (R1 / R2)$ To provide optimal ratio matching, resistors R3 and R4 have been chosen to be the same values and types as their counterparts R1 and R2, respectively.

Systems With Negative Supplies

A common start-up difficulty occurs if a regulator output is pulled below ground. This is possible in systems with negative power supplies. An easy fix is shown in Figure 3-16: adding a power diode, such as a 1N4001, from the regulator output to ground (with its anode to ground). This clamps the worst-case regulator output pin voltage to 0.6V or 0.7V and prevents start-up problems.

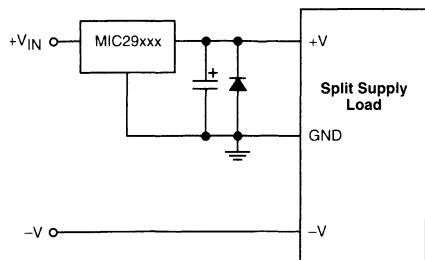

Figure 3-16. Diode Clamp Allows Start-Up in Split-Supply System

High Input Voltages

If the input voltage ranges above the maximum allowed by the regulator, a simple preregulator circuit may be employed, as shown in Figure 3-17. A preregulator is a crude regulator which drops extra voltage from the source to a value somewhat lower than the maximum input allowed by the regulator. It also helps thermal design by distributing the power dissipation between elements. The preregulator need not have good accuracy or transient response, since these parameters will be “cleaned up” by the final regulator.

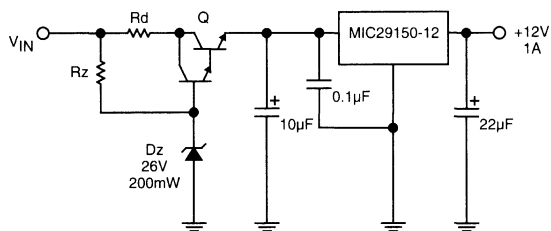

Figure 3-17. Preregulator Allows High Input Supply

Figure 3-17 shows the generic circuit. Table 3-3 provides component values for a typical application: +12V output at 1A. With up to 40V of input, no Rd is required. Above 40V, heat sinking is eased by power sharing with Rd. Note that a minimum input voltage is also listed; the composite regulator enters dropout below this minimum value. Assumptions made include a Q1 beta of 1000 and zener diode dissipation of 200mW. The MIC29150 dissipates a maximum of 13W; Q1 generates less than 15W of heat.

V _{MAX}	V _{MIN}	R _z	R _d
30V	15V	1.1kΩ	0
40V	17.5V	3.6kΩ	0
50V	23V	6.2kΩ	10Ω
60V	34V	8.87kΩ	20Ω

Table 3-3. Component Values for Figure 3-17

Controlling Voltage Regulator Turn-On Surges

When a power supply is initially activated, inrush current flows into the filter capacitors. The size of this inrush surge is dependent upon the size of the capacitors and the slew rate of the initial power-on ramp. Since this ramp plays havoc with the upstream power source, it should be minimized. Employing the minimum amount of capacitance is one method, but this technique does not solve the general problem. Slew rate limiting the power supply is a good solution to the general problem.

The turn-on time interval of a voltage regulator is essentially determined by the bandwidth of the regulator, its maximum output current (in current limit), and the load capacitance. To some extent, the rise time of the applied input voltage (which is normally quite short, tens of milliseconds, or less) also affects the turn-on time. However, the regulator output voltage typically steps abruptly at turn-on. Increasing the turn-on interval via some form of slew-limiting decreases the surge current seen by both the regulator and the system. These applications describe circuitry that changes the step-function to a smoother RC charge waveform.

Various performance differences exist between the three circuits that are presented. These are:

- (1) whether stability is impacted
- (2) whether start-up output voltage is 0V
- (3) whether the circuit quickly recovers from a momentarily interrupted input voltage or a shorted output.

Table 3-4 summarizes each circuit's features.

Circuit Figure	Stability Impacted?	Start-Up Pedestal?	V_{IN} Interrupt Recovery?	V_{OUT} Short Recovery?
3-18	yes	1.2V	no	no
3-20	no	1.8V	no	yes
3-22	no	0V	yes	no

Table 3-4. Slow Turn-On Circuit Performance Features

The Simplest Approach

Figure 3-18 illustrates a typical LDO voltage regulator, the MIC29152, with an additional capacitor (C_T) in parallel with the series leg ($R1$) of the feedback voltage divider. Since the voltage (V_{ADJ}) will be maintained at V_{REF} by the regulator loop, the output of this circuit will still rapidly step to V_{REF} (and then rise slowly). Since V_{REF} is usually only about 1.2V, this eliminates a large part of the surge current.

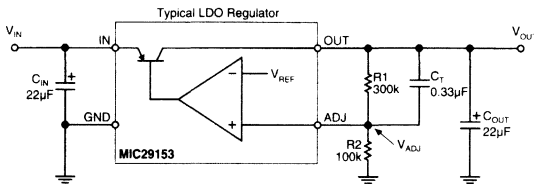

Figure 3-18. Simplest Slow Turn-On Circuit

As C_T charges, the regulator output (V_{OUT}) asymptotically approaches the desired value. If a turn-on time of 300 milliseconds is desired then about three time constants should be allowed for charge time: $3t = 0.3s$, or $t = 0.1s = R1 \times C_T = 300k\Omega \times 0.33\mu F$.

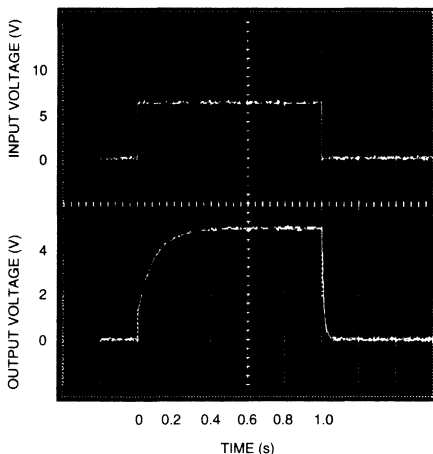

Figure 3-19. Turn-On Behavior for Circuit of Figure 3-18

Figure 3-19 shows the waveforms of the circuit of Figure 3-18. This circuit has three shortcomings: (1) the approximately 1.2V step at turn-on, (2) the addition of capacitor C_T places a zero in the closed-loop transfer function (which affects frequency and transient responses and can potentially cause stability problems) and (3) the recovery time associated with a momentarily short-circuited output may be unacceptably long³.

Improving the Simple Approach

Figure 3-20 addresses the problems of potential instability and recovery time. Diode D1 is added to the circuit to decouple the (charged) capacitor from the feedback network, thereby eliminating the effect of C_T on the closed-loop transfer function. Because of the non-linear effect of D1 being in series with C_T , there is a slightly longer “tail” associated with approaching the final output voltage at turn-on. In the event of a momentarily shorted output, diode D2 provides a low-impedance discharge path for C_T and thus assures the desired turn-on behavior.

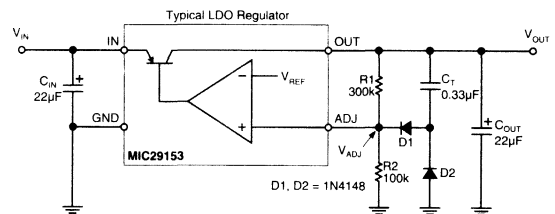

Figure 3-20. Improved Slow Turn-On Circuit

Figure 3-21 shows the waveforms of the circuit of Figure 3-20. Note that the initial step-function output is now 0.6V higher than with the circuit of Figure 3-18. This (approximately) 1.8V turn-on pedestal may

NOTE 3: This is because when the output is shorted, C_T is discharged only by R2; if the short is removed before C_T is fully discharged the regulator output will not exhibit the desired turn-on behavior.

be objectionable, especially in applications where the desired final output voltage is relatively low.

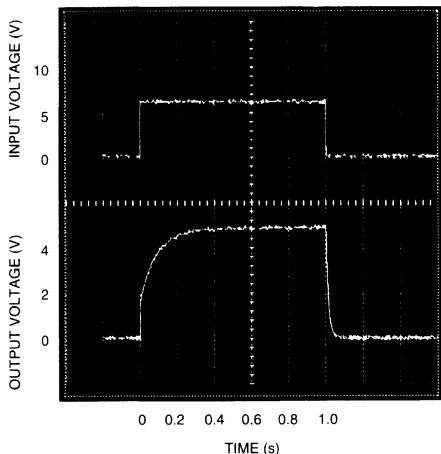

Figure 3-21. Turn-On Behavior of Figure 3-20.

Eliminating Initial Start-Up Pedestal

The circuits of Figures 3-18 and 3-19 depend upon the existence of an output voltage (to create V_{ADJ}) and, therefore, produce the initial step-function voltage pedestals of about 1.2V and 1.8V, as can be seen in Figures 3-19 and 3-21, respectively. The approach of Figure 3-22 facilitates placing the output voltage origin at zero volts because $V_{CONTROL}$ is derived from the input voltage. No reactive component is added to the feedback circuit. The value of R_T should be considerably smaller than R_3 to assure that the junction of R_T and C_T acts like a voltage source driving R_3 and so R_T is the primary timing control. If sufficient current is introduced into the loop summing junction (via R_3) to generate $V_{ADJ} \geq V_{REF}$, then V_{OUT} will be zero volts. As R_T charges C_T , $V_{CONTROL}$ decays, which would eventually result in $V_{ADJ} < V_{REF}$. In normal operation, $V_{ADJ} = V_{REF}$, so V_{OUT} becomes greater than zero volts. The process continues until $V_{CONTROL}$ decays to $V_{REF} + 0.6V$ and V_{OUT} reaches the desired value. This circuit requires a regulator with an enable function, (such as the MIC29152) because a small (< 2V) spike is generated coincident with application of a step-function input voltage. Capacitor C_1 and resistor R_4 provide a short hold-off timing function that eliminates this spike.

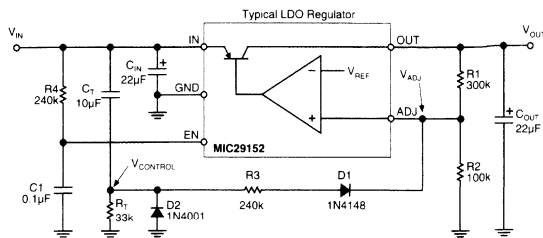

Figure 3-22. Slow Turn-On Without Pedestal Voltage

Figure 3-23 illustrates the timing of this operation. The small initial delay (about 40 milliseconds) is the time interval during which $V_{ADJ} > V_{REF}$. Since V_{IN} is usually fairly consistent in value R_3 may be chosen to minimize this delay. Note that if R_3 is calculated based on the minimum foreseen V_{IN} (as described below), then higher values of V_{IN} will produce additional delay before the turn-on ramp begins. Conversely, if $V_{IN(max)}$ is used for the calculation of R_3 , then lower values of V_{IN} will not produce the desired turn-on characteristic; instead, there will be a small initial step-function prior to the desired turn-on ramp. Recovery from a momentarily shorted output is not addressed by this circuit, but interrupted input voltage is handled properly. Notice that the buildup of regulator output voltage differs from the waveforms of Figures 3-19 and 3-21 in that it is more ramp-like (less logarithmic). This is because only an initial portion of the RC charge waveform is used; i.e., while $V_{CONTROL} > V_{REF} + 0.6V$. The actual time constant used for Figure 3-22 is 0.33 second, so $3t$ is one second. As shown by Figure 3-23, this provides about 600 milliseconds of ramp time, which corresponds to the first 60% of the capacitor RC charge curve. R_3 is calculated as follows:

at turn-on time force $V_{ADJ} = 1.5V$

(just slightly higher than V_{REF})

$$\text{then } I_{CONTROL} = \frac{1.5V}{\left(\frac{R_1 \times R_2}{R_1 + R_2}\right)}$$

$$\text{and } R_3 = \frac{V_{INmin} - 0.6V}{I_{CONTROL}}$$

Since the MIC29152 is a low-dropout regulator, 6V was chosen for $V_{IN(min)}$. This corresponds to the small (approximately 40msec) delay before the out-

put begins to rise. With 7V input the initial delay is considerably more noticeable.

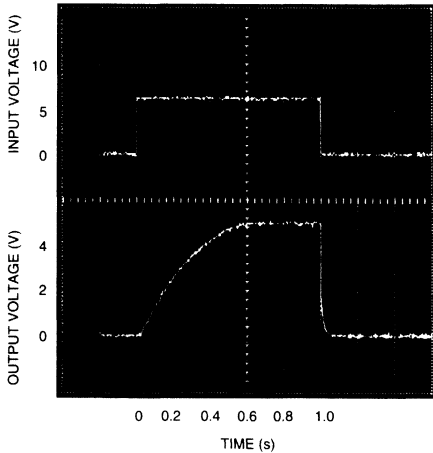

Figure 3-23. Turn-On Behavior of Figure 3-22.

Current Sources

Another major application for voltage regulators is current sources. Among other uses, most rechargeable batteries need some type of constant current chargers.

Simple Current Source

Several techniques for generating accurate output currents exist. The simplest uses a single resistor in the ground return lead (Figure 3-24). This technique works with all Micrel adjustable regulators except for the MIC5205 or the MIC5206. The output current is $V_{REF} \div R$. A drawback of this simple circuit is that power supply ground and load ground are not common. Also, compliance ranges from 0V to only $V_{OUT} - (V_{DO} + V_{REF})$.

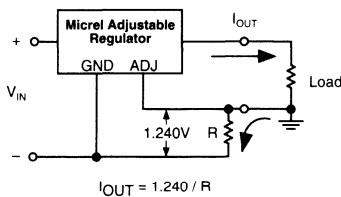

Figure 3-24. Simple Current Source Uses Reference Resistor in $-V$ Return

The Super LDO Current Source

The adjustable Super LDOs, MIC5156 and MIC5158, feature linear current limiting. This is referenced to an internal 35mV source. A simple, high efficiency, high output current source may be built (Figure 3-25). Current source compliance is excellent, ranging from zero volts to $V_{IN} - \text{dropout}$, which is only $I_{OUT} \times R_{DS(ON)} + 35\text{mV}$ (generally only a few hundred millivolts even at 10A). Output current is

$$I_{OUT} = 35\text{mV} \div R_s$$

This circuit suffers from relatively poor accuracy, however, since the 35mV threshold is not production trimmed. R1 and R2 allow clamping the output voltage to a maximum value, if desired.

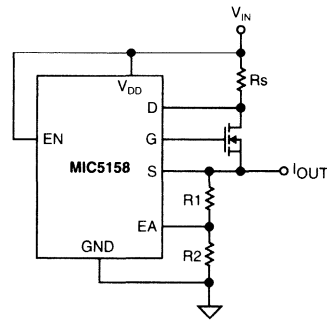

Figure 3-25. Simple Current Source Using the Super LDO

Accurate Current Source Using Op Amps

High accuracy and maintaining a common ground are both possible with an alternative circuit using two op amps and a low current MOSFET (Figure 3-26). This technique works with all Micrel adjustable regulators except for the MIC5205 and MIC5206. Compliance is from 0V to $V_{IN} - V_{DO}$.

A Low-Cost 12V & 5V Power Supply

Taking advantage of the low-dropout voltage capability of Micrel's regulators, we may build a dual output 12V & 5V linear power supply with excellent efficiency using a low cost 12.6V center-tapped "filament" transformer.

Figure 3-27 shows the schematic for the simple power supply. Using a single center-tapped transformer and one bridge rectifier, both 12V and 5V outputs are available. Efficiency is high because the transformer's RMS output voltage is only slightly above our desired outputs. The 12.6V center tapped

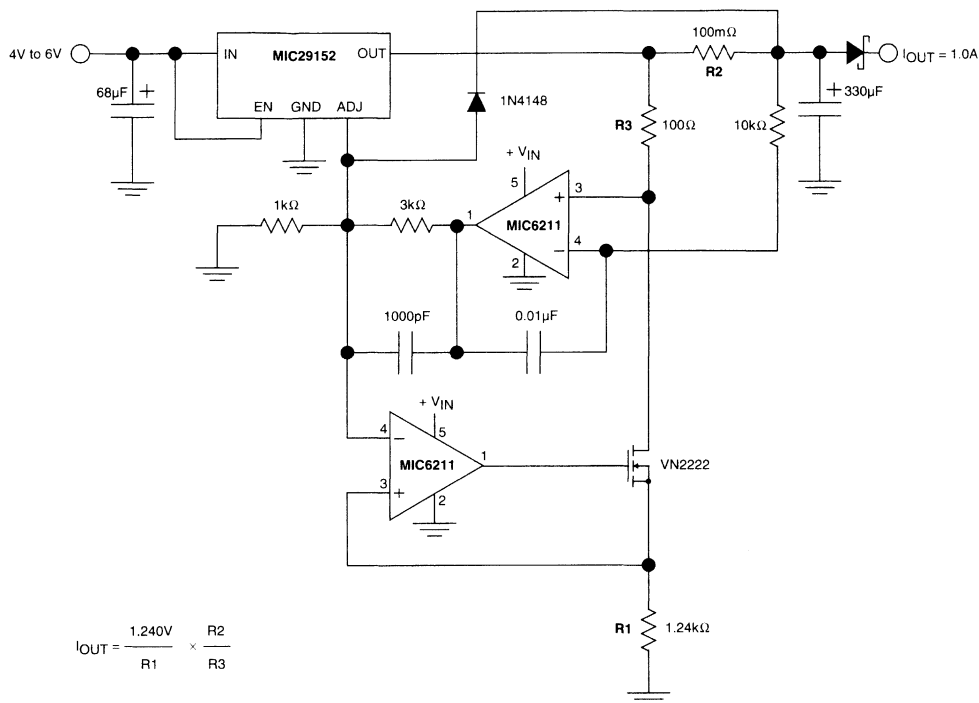

Figure 3-26. Current Source Using a Pair of Op-Amps

filament transformer is a decades-old design originally used for powering vacuum tube heaters. It is perhaps the most common transformer made. The outside windings feed the bridge rectifier and filter capacitor for the 12V output. A MIC29150-12 produces the regulated 12V output. The transformer center tap feeds the 5V filter capacitor and the MIC29150-5.0 directly—no rectifier diode is needed.

This circuit may be scaled to other output currents as desired. Overall efficiency is extremely high due to the low input voltage, so heat sinking requirements are minimal. A final benefit: since the power tabs of the TO-220 packages are at ground potential, a single non-isolated, non-insulated heat sink may be used for both regulators.

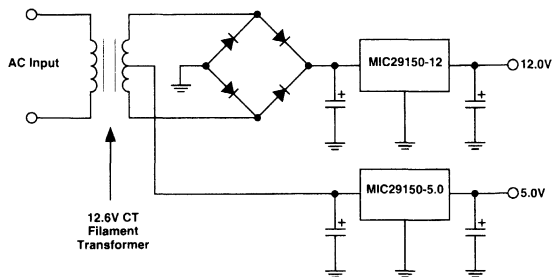

Figure 3-27. A Dual-Output Power Supply From a Single Transformer and Bridge Rectifier

Computer Power Supplies

The decreasing silicon geometries of microprocessors and memory have forced a reduction in operating voltage from the longtime standard of 5V. This rise of sub-5V microprocessors, logic, and memory components in personal computer systems created demand for lower voltage power supplies. Several options exist for the desktop computer system designer. One of these options is to provide both 3.3V and 5.0V from the main system power supply. Another is to use the existing high current 5V supply and employ a low dropout (LDO) linear regulator to provide 3.3V.

The low-cost, production proven desktop computer power supplies output $\pm 5V$ and $\pm 12V$ —but not 3V. Redesigning the system power supply would increase cost and break the long standing power supply to motherboard connector standard which has no provision for 3V. Further complicating matters is that “3V” is not really defined. Microprocessor manufacturers produce devices requiring 2.9V, 3.3V, 3.38V, 3.45V, 3.525V, 3.6V, and several other similar voltages. No single standard has been adopted. Designing and stocking dedicated power supplies for all of these different voltages would be extremely difficult and expensive. Also, motherboard makers want to maximize their available market by allowing as many different microprocessors as possible on each board; this means they must design an on-board supply that produces all of the most popular voltages to remain competitive. This is even more important for the motherboard vendors who sell boards sans-microprocessor. They must not only provide the expected voltages, they must simplify the selection process so that all system integrators—and even some end users—may configure the voltage properly. With too low an operating voltage, the microprocessor will generate errors; too high a voltage is fatal.

Instead, system integrators use motherboards with an on-board power supply, which converts the readily available +5V source into the required low voltage output. The simplest, lowest cost solution for this problem is the modern, very low dropout version of the venerable linear regulator. This is a low cost option, requiring only quick design work and little motherboard space. Linear regulators provide clean, accurate output and do not radiate RFI, so government certification is not jeopardized. Adjustable linear regulators allow voltage selection by means of

jumper-selected resistors. They are fast starting, and may optionally provide ON/OFF control and an error flag that indicates power system trouble.

Dropout Requirements

While linear regulators are extremely easy to use, one design factor must be considered: dropout voltage. For example, a regulator with 2 volts of dropout producing a 3.3V output requires over 5.3 volts on its input. Furthermore, reliable circuit operation requires operating a linear regulator above its dropout region—in other words, with a higher than minimum input voltage. In dropout, the regulator is not regulating and it responds sluggishly to load changes.

What is the required dropout voltage performance? Let's assume we have a 5V supply and need to provide 3.525V to our microprocessor. The worst case occurs when the input voltage from the 5V supply is at its minimum and the output is at its maximum. An example will illustrate.

$$V_{IN} = 5V - 5\% = 4.75V$$

$$V_{OUT} = 3.525V + 2\% = \underline{3.60V}$$

Maximum Allowable

Dropout Voltage: 1.15V

This simplified example does not include the effects of power supply connector, microprocessor socket, or PC board trace resistances, which would further subtract from the required dropout voltage. Fast response to load current changes (from a processor recovering from “sleep” mode, for example) occurs only when the regulator is away from its dropout point. In real systems, a maximum dropout voltage between 0.6V to 1V is ideal. Achieving this performance means the output device must be either a PNP bipolar transistor or a MOSFET.

Historically, linear regulators with PNP outputs have been expensive and limited to low current applications. However, Super Beta PNP low dropout regulators provide up to 7.5 amperes of current with dropout voltages less than 0.6V, guaranteed. A lower cost product line outputs the same currents with only 1V of dropout. These low dropout voltages guarantee the microprocessor gets a clean, well regulated supply that quickly reacts to processor-induced load changes as well as input supply variations.

The low dropout linear voltage regulator is an easy-to-use, low cost, yet high performance means

of powering high performance low voltage microprocessors. By selecting a modern low dropout regulator, you assure reliable operation under all working conditions.

5V to 3.xV Conversion Circuits

Recommended circuits for on-board desktop computer power supplies follow. Due to the high speed load changes common to microprocessors, fast load transient response is crucial. This means circuit layout and bypass and filter capacitor selection is also critical. At low current levels, thermal considerations are not difficult; however, at currents of above 3 amperes, the resulting heat may be troublesome.

Method 1: Use a Monolithic LDO

The simplest method of providing a second V_{CC} on a computer motherboard is by using a monolithic regulator. If the required voltage is a standard value, a fixed-voltage regulator is available. In this ideal situation, your electrical design consists of merely specifying a suitable output filter capacitor. If the output voltage is not available from a fixed regulator, adjustables are used. They use two resistors to program the output voltage but are otherwise similar to the fixed versions. Figure 3-28 and 3-29 show fixed and adjustable regulator applications.

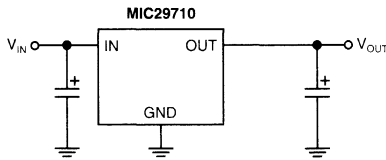

Figure 3-28. Fixed Regulator Circuit Suitable for Computer Power Supply Applications.

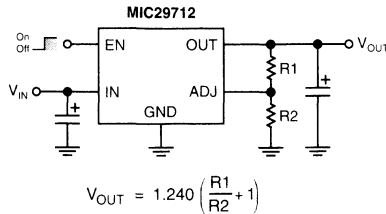

Figure 3-29. Adjustable Regulator Circuit Suitable for Computer Power Supply Applications.

Method 2: The MIC5156 “Super LDO”

The Micrel MIC5156 is a linear regulator controller that works with a low cost N-Channel power MOSFET to produce a very low dropout regulator system. The MIC5156 is available in a small 8-pin SOIC or in a standard 8-pin DIP, and offers fixed 3.3V, 5.0V, or user selectable (adjustable) voltage outputs. Figure 2 shows the entire schematic—two filter capacitors, a MOSFET, and a printed circuit board trace about a centimeter long (used as a current sense resistor) is all you need for the fixed voltage version. For the adjustable part, add two resistors. The MIC5156 requires an additional power supply to provide gate drive for the MOSFET: use your PC’s 12V supply—the current drawn from the 12V supply is very small; approximately one milliampere. If a 12V supply is not available, the MIC5158 generates its own bias and does not need an additional supply.

Figure 3-30 shows a typical 3.3V and 5V computer power supply application. The MIC5156 provides regulated 3.3V using Q1 as the pass element and also controls a MOSFET switch for the 5V supply.

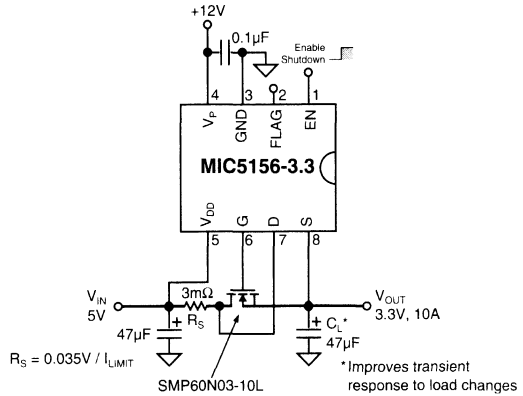

Figure 3-30. MIC5156 5V-to-3.3V Converter

When the 3.3V output has reached regulation, the FLAG output goes high, enhancing Q2, which switches 5V to Load 2. This circuit complies with the requirements of some dual-voltage microprocessors that require the 5V supply input to remain below 3.0V until the 3.3V supply input is greater than 3.0V.

An optional current limiting sense resistor (R_S) limits the load current to 12A maximum. For less costly designs, the sense resistor’s value and function can be duplicated using one of two techniques: A solid piece of copper wire with appropriate length and di-

ameter (gauge) makes a reasonably accurate low-value resistor. Another method uses a printed circuit trace to create the sense resistor. The resistance value is a function of the trace thickness, width, and length. See *Alternative Resistors*, in **Section 4**, for current sense resistor details.

NOTE: the tab of the power MOSFET is connected to +5V. Use an insulator between the MOSFET and the heat sink, if necessary.

Method 3: The MIC5158 “Super LDO”

Like the MIC5156, the MIC5158 is a linear regulator controller that works with a low cost N-Channel power MOSFET to produce a very low dropout regulator system. The MIC5158, however, generates the bias voltage required to drive the N-channel MOSFET and does not require a 12V supply. Its on-board charge pump uses three capacitors and takes care of the level shifting. Figure 3-31 shows the MIC5158 circuit.

An idea for the motherboard manufacturer: build the MIC5158 circuit on a plug-in daughterboard with three or five pins that allow it to mount on the system board like a monolithic regulator.

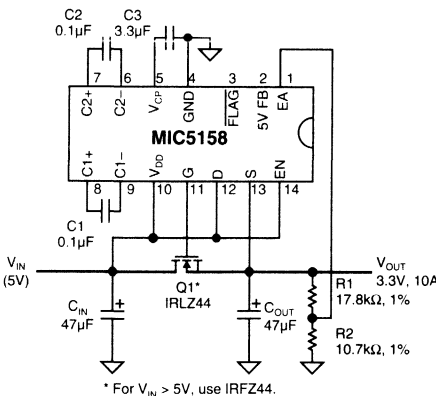

Figure 3-31. MIC5158 5V-to-3.3V Converter

Method 4: Current Boost a MIC2951

The 150mA MIC2951 gets a capacity boost to several amperes by using an external PNP transistor. Figure 3-32 shows the MIC2951 driving a DH45H8 or equivalent PNP transistor to achieve a 3A output. This circuit has a number of problems, including poor stability (a large output capacitor is required to squelch oscillations), poor current limiting characteristics, poor load transient response, no overtemperature shut-

down protection, and requires numerous external components. It is not recommended.

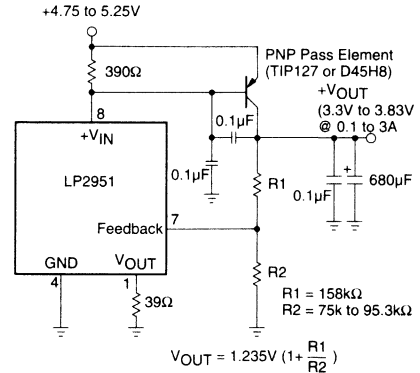

Figure 3-32. PNP Transistor Boosts Current Output From MIC2951 Regulator

Adjust Resistor Values

Table 3-5 shows recommended resistor values for various voltages. The values shown represent the calculated closest-match for the desired voltage using standard 1% tolerance resistors. Since Micrel’s adjustable regulators use a high impedance feedback stage, large value adjust resistors are generally recommended. Valid resistor values range from a few ohms to about 500kΩ.

While the MIC29152/29302/29502 have a 1.240V reference, the Super LDO and current boosted MIC2951 circuits use a 1.235V reference.

Voltage	Figs. 3-28 & 29 (V _{REF} = 1.240V)		Figs. 3-30, 31, & 32 (V _{REF} = 1.235V)	
	R1	R2	R1	R2
1.5	80.6k	16.9k	53.6k	11.5k
1.8	237k	107k	301k	137k
2.85	287k	221k	187k	143k
2.9	162k	121k	137k	102k
3.0	102k	71.5k	150k	105k
3.1	158k	105k	154k	102k
3.15	191k	124k	158k	102k
3.3	196k	118k	178k	107k
3.45	221k	124k	191k	107k
3.6	102k	53.6k	383k	200k
3.8	221k	107k	221k	107k
4.0	255k	115k	115k	51.1k
4.1	316k	137k	232k	100k
4.5	137k	52.3k	107k	40.2k

Table 3-5. Suggested Adjust Resistor Values

3.3V to 2.xV Conversion

Like the 5V to 3.3V conversion discussed above, dropping to voltages below 3.3V from a 3.3V rail is a useful application for LDO regulators. Here, the regulator dropout voltage is much more critical. Applications using 2.9V only have 400mV of headroom when powered from a perfect 3.3V supply. For the standard 3.3V supply tolerance of $\pm 300\text{mV}$, the headroom drops to only 100mV. For this situation, the most reasonable solution is one of the Super LDO circuits shown in Figures 3-30 and 3-31. These circuits feature excellent efficiency—approximately 88%. Monolithic LDO solutions powered from a standard $3.3\text{V} \pm 300\text{mV}$ supply become tenable with output voltages of 2.5V or below.

Improving Transient Response

Modern low-voltage microprocessors have multiple operating modes to maximize both performance and minimize power consumption. They switch between these modes quickly, however, which places a strain on their power supply. Supply current variations of several orders of magnitude in tens of nanoseconds are standard for some processors—and they still require that their supply voltage remain within specification throughout these transitions.

Micrel low-dropout regulators have excellent response to variations in input voltage and load current. By virtue of their low dropout voltage, these devices do not saturate into dropout as readily as similar NPN-based designs. A 3.3V output Super beta PNP LDO will maintain full speed and performance with an input supply as low as 4.2V, and will still provide some regulation with supplies down to 3.8V, unlike NPN devices that require 5.1V or more for good performance and become nothing more than a resistor under 4.6V of input. Micrel's PNP regulators provide superior performance in "5V to 3.3V" conversion applications, especially when all tolerances are considered.

Figure 3-33 is a test schematic using the Intel® Pentium™ Validator. The Validator is a dynamic load which simulates a Pentium processor changing states at high speed. Using Figure 3-33, the MIC29512 (Figure 3-34) was tested with fast 200mA to 5A load transitions. The MIC29712 was tested with fast transitions between 200mA and 7.5A (Figure 3-35).

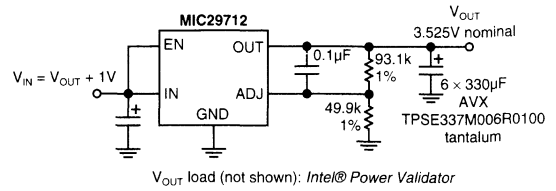

Figure 3-33. Load Transient Response Test Circuit. Super LDO system driving an Intel Pentium "Validator" test system.

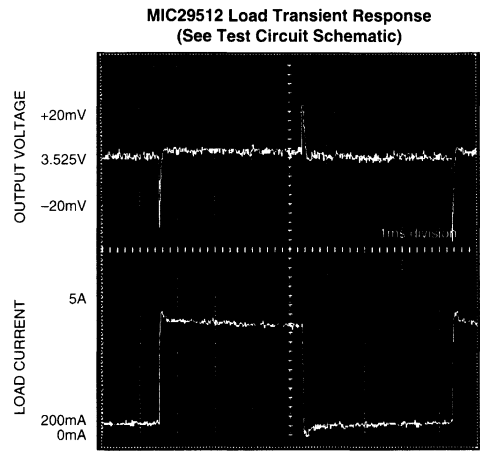

Figure 3-34. MIC29512 Load Transient Response.

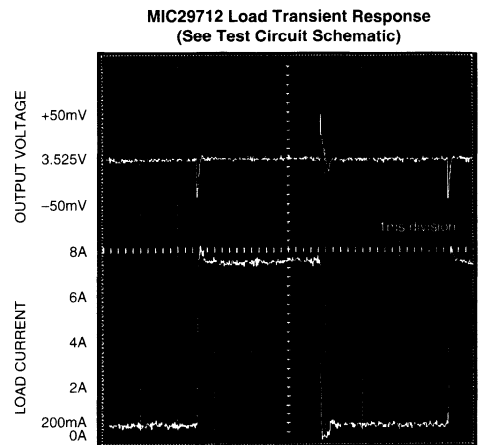

Figure 3-35. MIC29712 Load Transient Response. Load varies from 200mA to 7.5A.

The following photographs show the transient response of the MIC5156 Super LDO with an IRL3103 power MOSFET ($R_{DS(ON)} \leq 14\text{m}\Omega$, $C_{iss} = 1600\text{pF}$) driving the Intel Pentium™ Validator. Figure 3-36 shows the performance with four (4) $330\mu\text{F}$ AVX surface mount capacitors. The peak transient response voltage is -55mV on attack and $+60\text{mV}$ on turn-off. Figure 3-37 shows the tremendous improvement another four $330\mu\text{F}$ capacitors make: with eight (8) $330\mu\text{F}$ AVX capacitors, the transient peaks drop to only approximately $\pm 25\text{mV}$. These measurements are made with $V_{DD} = 5.0\text{V}$, $V_P = 12.0\text{V}$, and a single $330\mu\text{F}$ bypass capacitor on the V_{DD} input to the MIC5156. As both the 5156 and the MIC5158 use the same error amplifier circuit, their transient response should be similar. Furthermore, the transient response of the MIC5156 does not change as the input voltage (V_{DD}) decreases from 5.0V down to nearly dropout levels (a bit less than 3.6V input with the 3.525V output).

Accuracy Requirements

Microprocessors have various voltage tolerance requirements. Some are happy with supplies that swing a full $\pm 10\%$, while others need better than $\pm 2.5\%$ accuracy for proper operation. Fixed 3.3V devices operate well with any of these microprocessors, since Micrel guarantees better than $\pm 2\%$ across the operating load current and temperature ranges. Locating the regulator close to the processor to minimize lead resistance and inductance is the only design consideration that is necessary. Microprocessors that use nonstandard or varying voltages have a problem: while the basic adjustable regulator offers $\pm 1\%$ accuracy and $\pm 2\%$ worst case over temperature extremes, any error in the external programming resistors (either in tolerance or compromise in resistance ratio that is unavoidable when using standardized resistor values) directly appears as output voltage error. The error budget quickly disappears. See *Adjustable Regulator Accuracy Analysis*, in this section, for a discussion of voltage tolerance and sensitivity.

When any trace resistance effects are considered, it is painfully apparent that this solution will not provide the needed $\pm 2.5\%$ accuracy. Resistors of 0.1% tolerance are one step. Other ideas are presented in *Improving Regulator Accuracy*, also in this section.

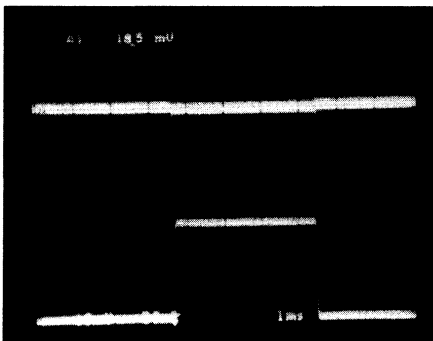

Figure 3-36. Transient response of the MIC5156 Super LDO driving an Intel Pentium “Validator” microprocessor simulator. Output capacitance is $4 \times 330\mu\text{F}$.

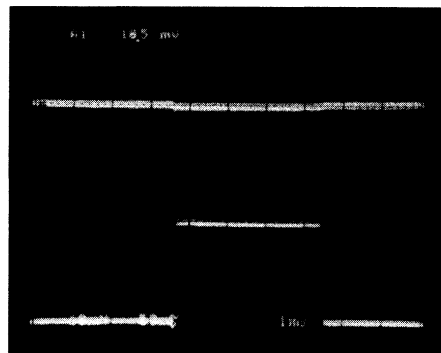

Figure 3-37. Transient response of the MIC5156 Super LDO driving an Intel Pentium “Validator” microprocessor simulator. Output capacitance is $8 \times 330\mu\text{F}$.

Multiple Output Voltages

Another design parameter computer motherboard designers cope with is the need to support different types of microprocessors with one layout. Since processors in a single family may require different voltages, it is no surprise that different processor types also may need various supply voltages. Since it is expensive to provide multiple variable outputs from the system power supply, the economical solution to this problem is to generate or switch between supplies directly on the motherboard.

Occasionally, a designer will get lucky and some motherboard options can use a standard voltage from the power supply. In this case, we may switch the higher voltage around the LDO generating the lower voltage, as shown in Figure 3-38. This circuit was designed to allow Intel DX4Processors™, running on 3.3V, to operate in the same socket as a standard 5V 486. A pin on the DX4Processor is hard wired to ground, which provides the switching needed for automatically selecting the supply voltage. Standard 486 processors have no connection to this pin.

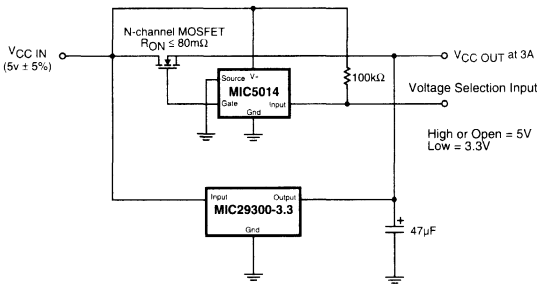

Figure 3-38. Switching 5V or 3.3V to a Microprocessor

This circuit capitalizes on the reversed-battery protection feature built into Micrel's Super β PNP regulators. The regulators survive a voltage forced on their output that is higher than their programmed output. In this situation, the regulator places its pass transistor in a high impedance state. Only a few microamperes of current leaks back into the regulator under these conditions, which should be negligible. Note that an adjustable regulator could be used in place of the fixed voltage version shown.

An adjustable regulator and an analog switch will perform this task, as shown in Figure 3-39. Only one supply (of the maximum desired output voltage, or higher) is necessary.

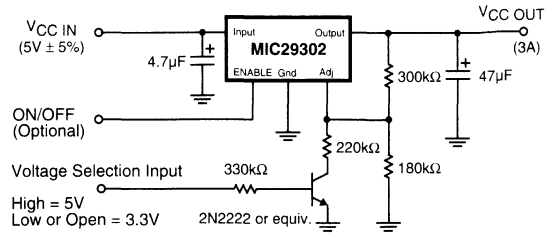

Figure 3-39. Adjustable LDO and analog switch provides selectable output voltages

Another method of providing two or more output voltages to a socket with the higher of the two provided is by using the Super LDO. Program the adjustable MIC5156 or MIC5158 as shown in Figure 3-40. When the higher of the two voltages is chosen, the regulator simply acts as a low-loss switch. Use a transistor switch to select the lower voltage. This technique may be expanded to any number of discrete voltages, if desired. The MIC5158 will operate from a single input supply of 3.0V or greater. The MIC5156 needs a low current 12V supply to provide gate bias for the pass MOSFET, but if this is available, it is smaller than the MIC5158 and requires no charge pump capacitors.

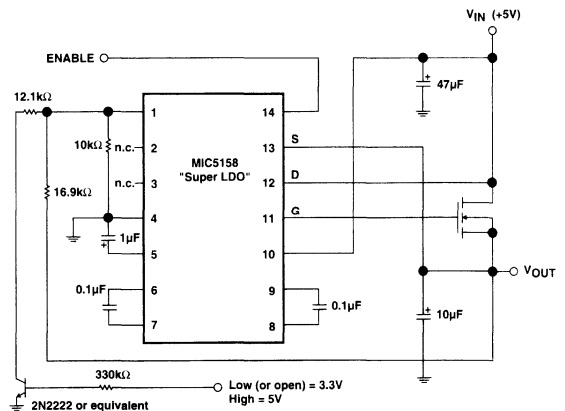
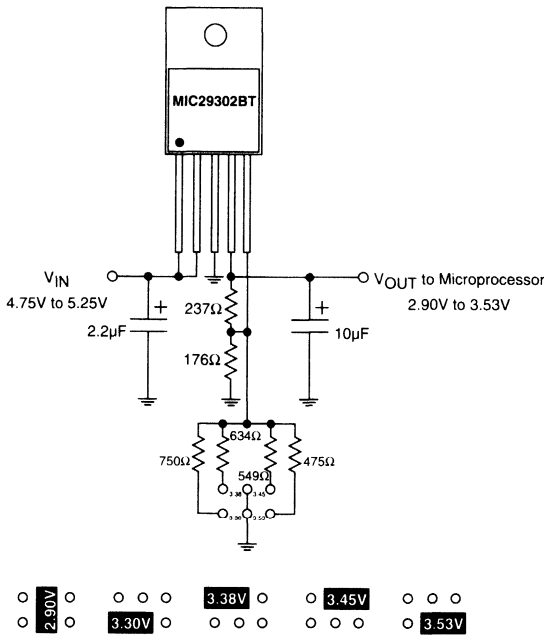

Figure 3-40. MIC5158 with Selectable Output Voltages

Figure 3-41 is a switched voltage PNP regulator that relies on jumpers for output voltage programming. While perhaps not as "elegant" as the previous techniques, it provides full functionality and flexibility. This circuit was designed so if all jumpers are accidentally removed, the output voltage drops to its lowest value. By configuring the jumpers as shown, the system is relatively safe—if someone inadvertently removes all



Voltage Jumper Positions

Figure 3-41. Jumper Selectable Output Voltages.

the jumpers, the output voltage drops to a low value. While the system may be error-prone or nonfunctional with this low voltage, at least the microprocessor will survive.

Multiple Supply Sequencing

Some microprocessors use multiple supply voltages; a voltage for the core, another for the cache memory, and a different one for I/O, for example. Sequencing these supplies may be critical to prevent latch-up. Figure 3-42 shows an easy way of guaranteeing this sequencing using Micrel's regulators with an enable control. As the output voltage of Supply 1 rises above 2V, the regulator for Supply 2 starts up. Supply 2 will never be high until Supply 1 is active. Supply 1 need not be the higher output voltage; it must only be 2.4V or above (necessary to assure the second regulator is fully enabled). Note that Supply 1 may not need an enable pin.

This technique works with the MIC29151 through MIC29752 monolithic regulators as well as with the Super LDO (MIC5156/57/58). It also is applicable for systems requiring any number of sequenced supplies, although for simplicity we only show two supplies here.

Thermal Design

Once the electrical design of your power system is complete, we must deal with thermal issues. While they are not terribly difficult, thermal design is lightly covered in most electrical engineering curriculum. Properly addressing thermal issues is imperative to LDO system reliability, and is covered in detail in *Thermal Management*, later in this section.

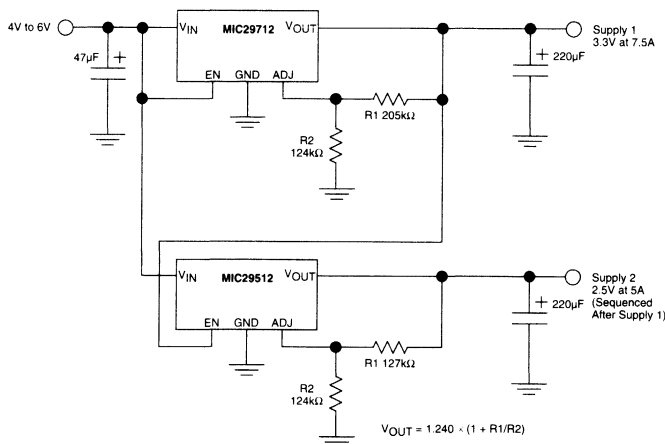

Figure 3-42. Multiple Supply Sequencing.

Portable Devices

Voltage regulators are necessary in almost all electronic equipment, and portable devices are no exception. Portable equipment includes cellular and “wireless” telephones, radio receivers and handheld transceivers, calculators, pagers, notebook computers, test equipment, medical appliances and most other battery operated gear.

Design Considerations

Portable electronics are characterized by two major distinguishing features:

- Small size
- Self-contained power source (batteries)

Beyond these similarities, portable equipment power requirements vary as much as their intended application.

Small Package Needed

Portable devices are, by definition, relatively small and lightweight. Most circuitry is surface mounted and power dissipation is normally minimized.

Self Contained Power

Most portable equipment is battery powered. Batteries are often the largest and heaviest component in the system, and may account for 80% or more of the total volume and mass of the portable device. Power conservation is an important design consideration. Low power components are used and power management techniques, such as “sleep mode”, help maximize battery life. Just as one is never too rich, one’s batteries never last long enough!

Yet another battery-imposed limitation is that batteries are available in discrete voltages, determined by their chemical composition. Converting these voltages into a constant supply suitable for electronics is the regulator’s most important task.

Low Current (And Low Voltage)

The regulators used in portable equipment are usually low output current devices, generally under 250mA, since their loads are also (usually) low current. Few portable devices have high voltage loads⁴ and those that do need little current.

Low Output Noise Requirement

Cellular telephones, pagers, and other radios have frequency synthesizers, preamplifiers, and mixers that are susceptible to power supply noise. The frequency synthesizer voltage controlled oscillator (VCO), the block that determines operating frequency, may produce a noisy sine wave output (a wider bandwidth signal) if noise is present on V_{CC} . Making matters worse for portable equipment designers, lower powered/lower cost VCOs are generally more susceptible to V_{CC} noise.

Ideal VCOs produce a single spectral line at the operating frequency. Real oscillators have sideband skirts; poor devices have broad skirts. Figure 3-43 shows the measured phase noise from a free running Murata MQE001-953 VCO powered by a MIC5205 low-noise regulator. Note the significant improvement when using the noise bypass capacitor. Regulators not optimized for noise performance produce skirts similar to or worse than the MIC5205 without bypass capacitors.

Broad oscillator skirts decrease the noise figure and the strong signal rejection capability of receivers (reducing performance) and broaden the transmitted signal in transmitters (possibly in violation of spectral purity regulations).

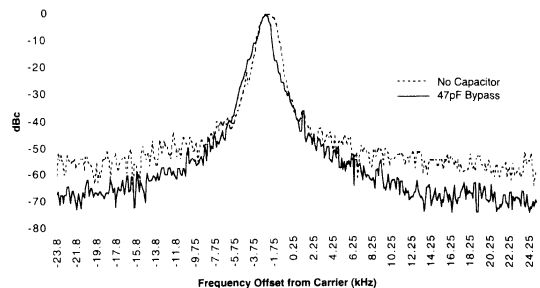

Figure 3-43. A Low Noise LDO (MIC5205) Reduces VCO Phase Noise.

Although not as susceptible to noise as VCOs, preamplifiers and mixers operating from noisy supplies also reduce receiver and transmitter performance in similar ways.

NOTE 4: The notable exceptions to this statement are the fluorescent backlights in notebook computers and the electroluminescent lamps in telephones, watches, etc. And these lamps must be driven with a switching regulator that boosts the battery voltage—something a linear regulator cannot do.

Dropout and Battery Life

Low dropout regulators allow more operating life-time from batteries by generating usable output to the load well after standard regulators would be saturated. This allows discharging batteries to lower levels or—in many cases—eliminating a cell or two from a series string. Compared to older style regulators with 2 to 3V of dropout, Micrel's 0.3V to 0.6V LDOs allow eliminating one to two alkaline, NiCd, or NiMH cells.

Ground Current and Battery Life

The quiescent, or ground, current of regulators employed inside portable equipment is also important. This current is yet another load for the battery, and should be minimized.

Battery Stretching Techniques

Sleep Mode Switching

Sleep mode switching is an important technique for battery powered devices. Basically, sleep mode switching powers down system blocks not immediately required. For example, while a cellular phone must monitor for an incoming call, its transmitter is not needed and should draw no power; it can be shut off. Likewise, audio circuits may be powered down. Portable computers use sleep mode switching by spinning down the hard disk drive and powering down the video display backlight, for example. Simpler devices like calculators automatically turn off after a certain period of inactivity.

Micrel's LDO regulators make sleep mode implementation easy because each family has a version with logic-compatible shutdown control. Many families feature "zero power" shutdown—when disabled, the regulator fully powers down and draws virtually

zero current.⁵ Designers updating older systems that used MOSFETs for switching power to regulators may now eliminate the MOSFET. The regulator serves as switch, voltage regulator, current limiter, and overtemperature protector. All are important features in any type of portable equipment.

Power Sequencing

A technique related to Sleep Mode Switching is Power Sequencing. This is a power control technique that enables power blocks for a short while and then disables them. For example, in a cellular telephone awaiting a call, the receiver power may be pulsed on and off at a low-to-medium duty cycle. It listens for a few milliseconds each few hundred milliseconds.

Multiple Regulators Provide Isolation

The close proximity between different circuit blocks naturally required by portable equipment increases the possibility of interstage coupling and interference. Digital noise from the microprocessor may interfere with a sensitive VCO or a receiver preamplifier, for example. A common path for this noise is the common supply bus. Linear regulators help this situation by providing active isolation between load and input supply. Noise from a load that appears on the regulator's output is greatly attenuated on the regulator's input.

Figure 3-44 shows a simplified block diagram of a cellular telephone power distribution system. Between five and seven regulators are used in a typical telephone, providing regulation, ON/OFF (sleep mode) switching, and active isolation between stages.

NOTE 5: In the real world, there is no such thing as zero, but Micrel's regulators pass only nanoamperes of device leakage current when disabled—"virtually zero" current.

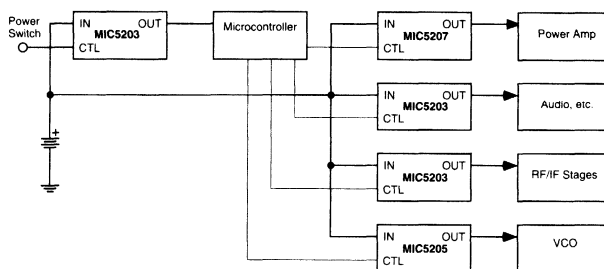

Figure 3-44. Cellular Telephone Block Diagram

Thermal Management

A Thermal Primer

Micrel low dropout (LDO) regulators are very easy to use. Only one external filter capacitor is necessary for operation, so the electrical design effort is minimal. In many cases, thermal design is also quite simple, aided by the low dropout characteristic of Micrel's LDOs. Unlike other linear regulators, Micrel's LDOs operate with dropout voltages of 300mV—often less. The resulting Voltage \times Current power loss can be quite small even with moderate output current. At higher currents and/or higher input-to-output voltage differentials, however, selecting the correct heat sink is an essential "chore".

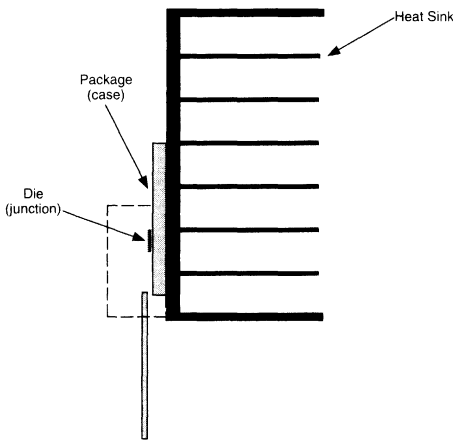

Figure 3-45. Regulator mounted to a heat sink.

Thermal Parameters

Before working with thermal parameters, we will define the applicable symbols and terms.

- ΔT Temperature rise (temperature difference, $^{\circ}C$)
- q Heat flow (Watts)
- θ Thermal resistance ($^{\circ}C/W$)
- P_D Power Dissipation (Watts)
- θ_{JA} Thermal resistance, junction (die) to ambient (free air)
- θ_{JC} Thermal resistance, junction (die) to the package (case)
- θ_{CS} Thermal resistance, case (package) to the heat sink

- θ_{SA} Thermal resistance, heat sink to ambient (free air)
- T_A Ambient temperature
- T_J Junction (die) temperature
- $T_{J(MAX)}$ Maximum allowable junction temperature

Figure 3-46 shows the thermal terms as they apply to linear regulators. The "junction" or "die" is the active semiconductor regulator; this is the heat source. The package shown is the standard TO-220; the "case" is the metal tab forming the back of the package which acts as a heat spreader. The heat sink is the interface between the package and the ambient environment. Between each element—junction, package, heat sink, and ambient—there exists interface thermal resistance. Between the die and the package is the junction to case thermal resistance, θ_{JC} . Between the package and the heat sink is the case-to-sink thermal resistance, θ_{CS} . And between the heat sink and the external surroundings is the heat sink to ambient thermal resistance, θ_{SA} . The total path from the die to ambient is θ_{JA} .

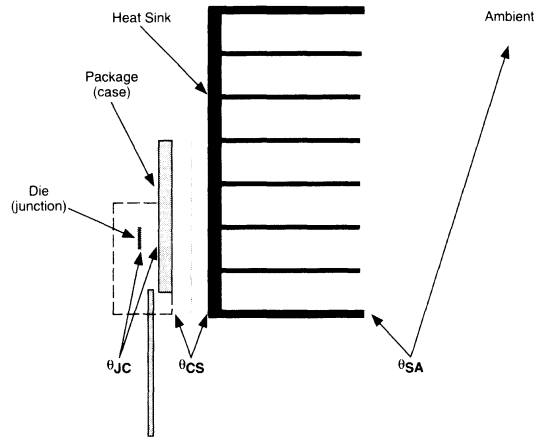

Figure 3-46. Thermal Parameters.

Thermal/Electrical Analogy

For those of us more comfortable with the laws of Kirchhoff and Ohm than those of Boyle or Celsius, an electrical metaphor simplifies thermal analysis. Heat flow and current flow have similar characteristics. Table 3-6 shows the general analogy.

Thermal Parameter	Electrical Parameter
Power (q)	Current (I)
Thermal Resistance (θ)	Resistance (R)
Temperature Difference (ΔT)	Voltage (V)

Table 3-6. Thermal/Electrical Analogy

The formula for constant heat flow is

$$\theta = \Delta T / q$$

The equivalent electrical (Ohm's Law) form is:

$$I = \Delta V / R$$

Electrically, a voltage difference across a resistor produces current flow. Thermally, a temperature gradient across a thermal resistance creates heat flow. From this, we deduce that if we dissipate power as heat and need to minimize temperature rise, we must minimize the thermal resistance. Taken another way, if we have a given thermal resistance, dissipating more power will increase the temperature rise.

Thermal resistances act like electrical resistances: in series, they add; in parallel, their reciprocals add and the resulting sum is inverted. The general problem of heat sinking power semiconductors may be simplified to the following electrical schematic (Figure 3-47).

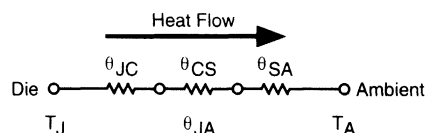

Figure 3-47. Heat flow through the interface resistances.

Summing these resistances, the total thermal path for heat generated by the regulator die is

$$\theta_{JA} = \theta_{JC} + \theta_{CS} + \theta_{SA}$$

Calculating Thermal Parameters

Two types of thermal parameters exist; those we may control and those fixed by the application (or physics). The application itself determines which category the parameters fit—some systems have a specific form factor dictated by other factors, for example.

This serves to limit the maximum heat sink size possible.

Parameter	Extenuating Circumstances
θ_{SA}	Set by heat sink size, design and air flow
θ_{JC}	Set by regulator die size and package type
θ_{CS}	Set by mounting technique and package type
$T_{J(MAX)}$	Set by regulator manufacturer and lifetime considerations
Power dissipation	Set by V_{IN} , V_{OUT} , and I_{OUT}

Each regulator data sheet specifies the junction to case thermal resistance, θ_{JC} . Heat sink manufacturers specify θ_{SA} , (often graphically) for each product. And θ_{CS} is generally small compared to θ_{JC} . The maximum die temperature for Micrel regulators is generally 125°C, unless specified otherwise on the data sheet. The last remaining variable is the regulator power dissipation.

Power dissipation in a linear regulator is:

$$P_D = [(V_{IN} - V_{OUT}) I_{OUT}] + (V_{IN} \times I_{GND})$$

Where:

P_D = Power dissipation

V_{IN} = Input voltage applied to the regulator

V_{OUT} = Regulator output voltage

I_{OUT} = Regulator output current

I_{GND} = Regulator biasing currents

Proper design dictates use of worst case values for all parameters. Worst case V_{IN} is high supply. Worst case V_{OUT} for thermal considerations is the lowest possible output voltage, subtracting all tolerances from the nominal output. I_{OUT} is taken at its highest steady-state value. The ground current value comes from the device's data sheet, from the graph of I_{GND} vs. I_{OUT} .

Calculating Maximum Allowable Thermal Resistance

Given the power dissipation, ambient operating temperature, and the maximum junction temperature of a regulator, the maximum allowable thermal resistance is readily calculated.

$$\theta_{JA} \leq (T_J(\text{MAX}) - T_A) / P_D$$

Maximum heat sink thermal resistance is

$$\theta_{SA} \leq \theta_{JA} - (\theta_{JC} + \theta_{CS})$$

We calculate the thermal resistance (θ_{SA}) required of the heat sink using the following formula:

$$\theta_{SA} = \frac{T_J - T_A}{P_D} - (\theta_{JC} + \theta_{CS})$$

Why A Maximum Junction Temperature?

Why do semiconductors, including LDO regulators, have a maximum junction temperature (T_J)? Heat is a natural enemy of most electronic components, and regulators are no exception. Semiconductor lifetimes, statistically specified as mean time to failure (MTTF) are reduced significantly when they are operated at high temperatures. The junction temperature, the temperature of the silicon die itself, is the most important temperature in this calculation. Device manufacturers have this lifetime-versus-operating temperature trade-off in mind when rating their devices. Power semiconductor manufacturers must also deal with the inevitable temperature variations across the die surface, which are more extreme for wider temperature-range devices. Also, the mechanical stress induced on the semiconductor, its package, and its bond wires is increased by temperature cycling, such as that caused by turning equipment on and off. A regulator running at a lower maximum junction temperature has a smaller temperature change, which creates less mechanical stress.

The expected failure rate under operating conditions is very small, and expressed in FITs (failures in time), which is defined as failures per one billion device hours. Deriving the failure rate from the operating life test temperature to the actual operating temperature is performed using the Arrhenius equation:

$$\frac{FR1}{FR2} = \frac{MTTF2}{MTTF1} = e^{\left(\frac{E_a}{k}\right)\left(\frac{1}{T_2} - \frac{1}{T_1}\right)}$$

Where:

FR1 is the failure rate at temperature T1 (Kelvin)

FR2 is the failure rate at temperature T2

MTTF1 is the mean time to failure at T1

MTTF2 is the mean time to failure at T2

Ea is the activation energy in electron volts (eV)

k is Boltzmann's constant (8.617386×10^{-5} eV/K)

The activation energy is determined by long-term burn-in testing. An average value of 0.62eV is determined, after considering all temperature-related failure mechanisms, including silicon-related failure modes and packaging issues, such as the die attach, lead bonding, and package material composition. Using a reference temperature of 125°C (498K) and normalizing to 100 FITs, the formula becomes:

$$\frac{100}{FR2} = e^{\left(\frac{0.62}{k}\right)\left(\frac{1}{T_2} - \frac{1}{498}\right)}$$

The standard semiconductor reliability versus junction temperature characteristic is shown in Figure 3-48. We see that a device operating at 125°C has a relative lifetime of 100. For each 15°C rise in junction temperature, the MTTF halves. At 150°C, it drops to about 34. On the other hand, at 100°C, its life is more than tripled, and at 70°C, it is 1800.

As a designer of equipment using LDOs, the most important rule to remember is “cold is cool; hot is not”. Minimizing regulator temperatures will maximize your product’s reliability.

Arrhenius Plot

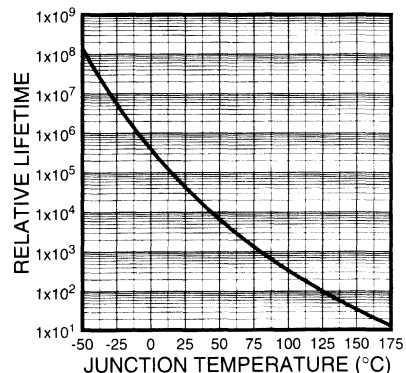

Figure 3-48. Typical MTTF vs. Temperature Curve.

Heat Sink Charts for High Current Regulators

The heat sink plays an important role in high current regulator systems, as it directly affects the safe operating area (SOA) of the semiconductor. The following graphs, Figure 3-49 through 3-53, show the maximum output current allowable with a given heat

sink for different input-output voltages at an ambient temperature of 25°C. Three curves are shown: no heat sink, nominal heat sink, and infinite heat sink ($\theta_{SA} = 0$). Additional thermal design graphs appear in **Section 2**.

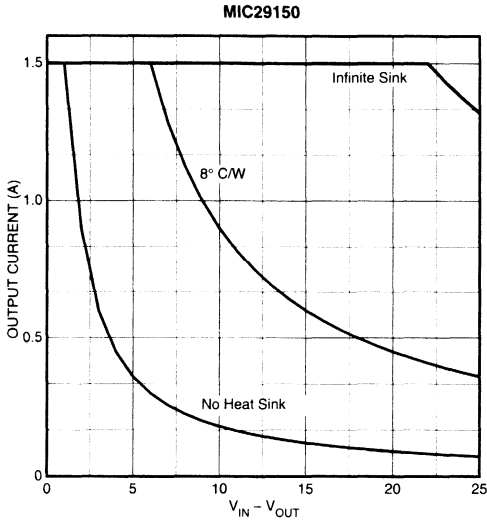

Figure 3-49. Maximum Output Current With Different Heat Sinks, MIC29150 series.

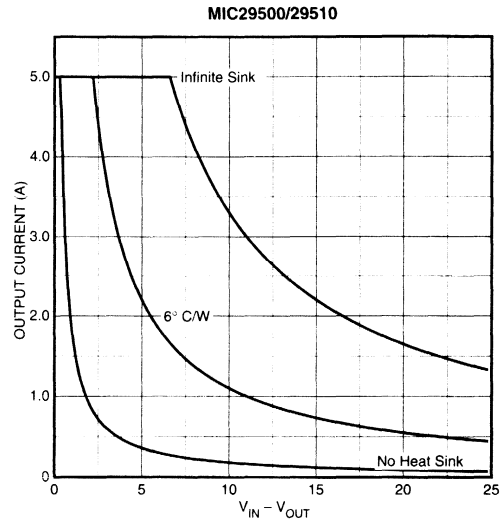

Figure 3-51. Maximum Output Current With Different Heat Sinks, MIC29500 series.

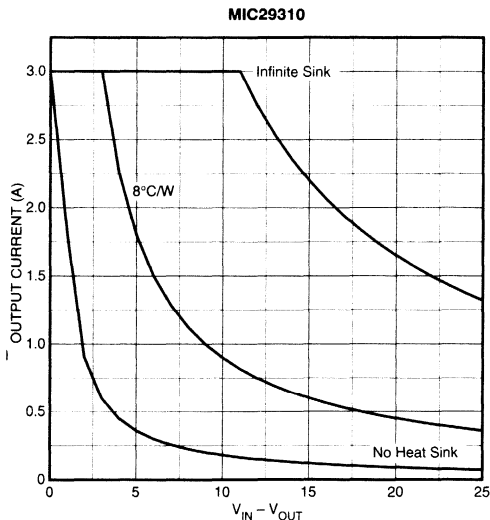

Figure 3-50. Maximum Output Current With Different Heat Sinks, MIC29300 series.

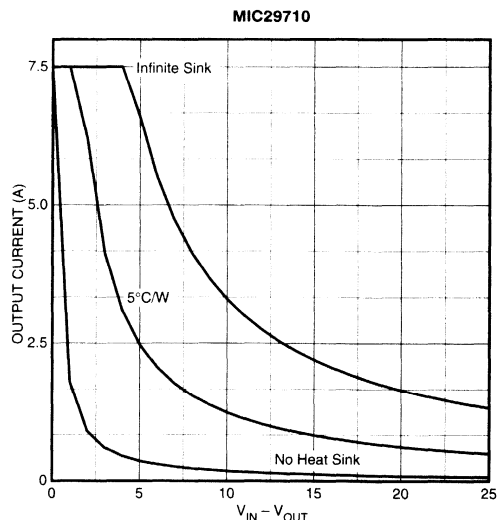

Figure 3-52. Maximum Output Current With Different Heat Sinks, MIC29710/MIC29712.

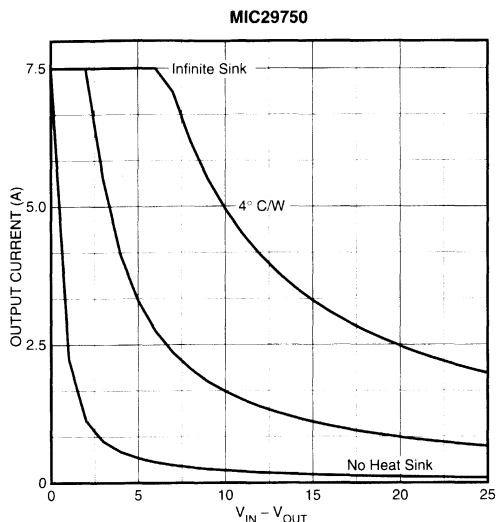

Figure 3-53. Maximum Output Current With Different Heat Sinks, MIC29750/MIC29752.

Thermal Examples

Let's do an example. We need to design a power supply for a low voltage microprocessor which requires 3.3V at up to 3A. It will get its input from a 5V ±5% supply. We choose a MIC29300-3.3BT for our regulator. The worst case V_{IN} is high supply; in this case, 5V + 5%, or 5.25V. The LDO has a maximum die temperature of 125°C in its TO-220 package with a θ_{JC} of 2°C/W and a mounting resistance (θ_{CS}) of 1°C/W², and will operate at an ambient temperature of 50°C. Worst case V_{OUT} for thermal considerations is minimum, or 3.3V - 2% = 3.234V.⁵ I_{OUT} is taken at its highest steady-state value. The ground current value comes from the device's data sheet, from the graph of I_{GND} vs. I_{OUT}.

Armed with this information, we calculate the thermal resistance (θ_{SA}) required of the heat sink using the previous formula:

$$\theta_{SA} = \frac{125 - 50^{\circ}\text{C}}{10.5\text{W}} - (2 + 1^{\circ}\text{C/W}) = 4.1^{\circ}\text{C/W}$$

NOTE 5: Most Micrel regulators are production trimmed to better than ±1% accuracy under standard conditions. Across the full temperature range, with load current and input voltage variations, the device output voltage varies less than ±2%.

Performing similar calculations for 1.25A, 1.5A, 2.0A, 2.5A, 3.0A, 4.0A, and 5.0A gives the results shown in Table 3-7. We choose the smallest regulator for the required current level to minimize cost.

Regulator	I _{OUT}	P _D (W)	θ _{SA} (°C/W)
MIC29150	1.25A	2.6	25
MIC29150	1.5A	3.2	21
MIC29300	2.0A	4.2	15
MIC29300	2.5A	5.2	11
MIC29300	3.0A	6.3	8.8
MIC29500	4.0A	8.4	5.9
MIC29500	5.0A	10.5	4.1

Table 3-7. Micrel LDO power dissipation and heat sink requirements for various 3.3V current levels.

Table 3-8 shows the effect maximum ambient temperature has on heat sink thermal properties. Lower thermal resistances require physically larger heat sinks. The table clearly shows cooler running systems need smaller heat sinks, as common sense suggests.

Output	Ambient Temperature		
	40°C	50°C	60°C
1.5A	24°C/W	21°C/W	17°C/W
5A	5.1°C/W	4.1°C/W	3.2°C/W

Table 3-8. Ambient temperature affects heat sink requirements

Although routine, these calculations become tedious. A program written for the HP 48 calculator is available from Micrel that will calculate any of the above parameters and ease your design optimization process. It will also graph the resulting heat sink characteristics versus input voltage. See Appendix C for the program listing or send e-mail to Micrel at apps@micrel.com and request program "LDO SINK for the HP48".

```

==Regulator Thermals==
Output V: 3.30
Output I: 3.00
Vin: 5.50
θjc: 2.00
θcs: 0.50
Ambient Temp: 50.00°C
GRAF SOLVR REVR WPRR WMIN WEXT
    
```



Figure 3-54. “LDO SINK” Calculator Program eases tedious thermal calculations. (See Appendix C).

Heat Sink Selection

With this information we may specify a heat sink. The worst case is still air (natural convection). The heat sink should be mounted so that at least 0.25 inches (about 6mm) of separation exists between the sides and top of the sink and other components or the system case. Thermal properties are maximized when the heat sink is mounted so that natural vertical motion of warm air is directed along the long axis of the sink fins.

If we are fortunate enough to have some forced airflow, reductions in heat sink cost and space are possible by characterizing air speed—even a slow air stream significantly assists cooling. As with natural convection, a small gap allowing the air stream to pass is necessary. Fins should be located to maximize airflow along them. Orientation with respect to vertical is not very important, as airflow cooling dominates the natural convection.

As an example, we will select heat sinks for 1.5A and 5A outputs. We consider four airflow cases: natural convection, 200 feet/minute (1m/sec), 300 feet/minute (1.5m/sec), and 400 feet/minute (2m/sec). Table 3 shows heat sinks for these air velocities; note the rapid reduction in size and weight (fin thickness) when forced air is available. Consulting manufacturer’s charts, we see a variety of sinks are made that are suitable for our application. At 5A (10.5W worst case package dissipation) and natural

convection, sinks are sizable, but at 1.5A (3.2W worst case package dissipation) and 400 feet/minute airflow, modest heat sinks are adequate.

Output Current		
Airflow	1.5A	5A
400 ft./min. (2m/sec)	Thermalloy 6049PB	Thermalloy 6232 Thermalloy 6034 Thermalloy 6391B
		AAVID 504222B AAVID 563202B AAVID 593202B AAVID 534302B Thermalloy 7021B Thermalloy 6032 Thermalloy 6234B
300 ft./min. (1.5m/sec)		AAVID 508122 AAVID 552022 AAVID 533302 Thermalloy 7025B Thermalloy 7024B Thermalloy 7022B Thermalloy 6101B
	200 ft./min. (1m/sec)	AAVID 577002 Thermalloy 6043PB Thermalloy 6045B
Natural Convection (no forced airflow)	AAVID 576000 AAVID 574802 592502 579302 Thermalloy 6238B Thermalloy 6038 Thermalloy 7038	AAVID 533602B (v) AAVID 519922B (h) AAVID 532802B (v) Thermalloy 6299B (v) Thermalloy 7023 (h)

Table 3-9. Commercial heat sinks for 1.5A and 5.0A applications. Vertical mounting is denoted by (v); (h) means horizontal mounting.

Reading Heat Sink Graphs

Major heat sink manufacturers provide graphs showing their heat sink characteristics. The standard graph (Figure 3-55) depicts two different data: one curve is the heat sink thermal performance in still air (natural convection); the other shows the performance possible with forced cooling. The two graphs should be considered separately since they do not share common axes. Both are measured using a single device as a heat source: if multiple regulators are attached, thermal performance improves by as much as one-third (see *Multiple Packages on One Heat Sink*, below).

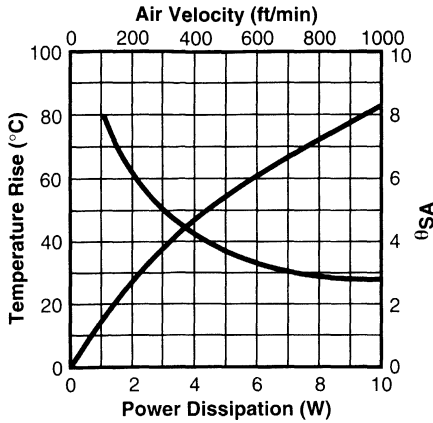

Figure 3-55. Typical Heat Sink Performance Graph

Figure 3-56 shows the natural convection portion of the curve. The x-axis shows power dissipation and the y-axis represents temperature rise over ambient. While this curve is nearly linear, it does exhibit some droop at larger temperature rises, representing increased thermodynamic efficiency with larger ΔT . At any point on the curve, the θ_{SA} is determined by dividing the temperature rise by the power dissipation.

Figure 3-57 shows the thermal resistance of the heat sink under forced convection. The x-axis (on top, by convention) is air velocity in lineal units per minute. The y-axis (on the right side) is θ_{SA} .

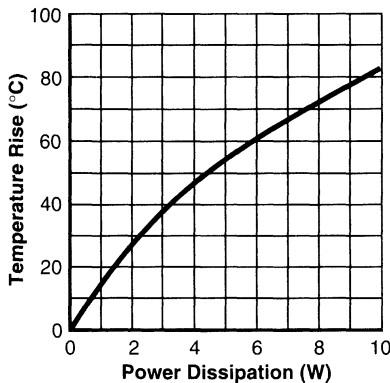

Figure 3-56. Natural Convection Performance

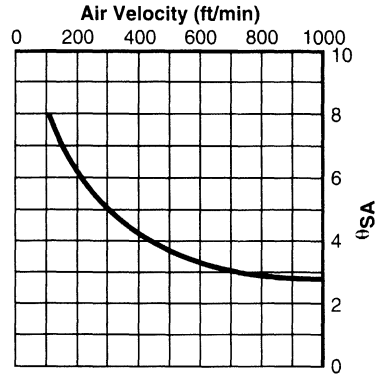

Figure 3-57. Forced Convection Performance

Power Sharing Resistor

The heat sink required for 5A applications in still air is massive and expensive. There is a better way to manage heat problems: we take advantage of the very low dropout voltage characteristic of Micrel's Super Beta PNP™ regulators and dissipate some power externally in a series resistance. By distributing the voltage drop between this low cost resistor and the regulator, we distribute the heating and reduce the size of the regulator heat sink. Knowing the worst case voltages in the system and the peak current requirements, we select a resistor that drops a portion of the excess voltage without sacrificing performance. The maximum value of the resistor is calculated from:

$$R_{MAX} = \frac{V_{IN(MIN)} - (V_{OUT(MAX)} + V_{DO})}{I_{OUT(PEAK)} + I_{GND}}$$

Where: $V_{IN(MIN)}$ is low supply ($5V - 5\% = 4.75V$)

$V_{OUT(MAX)}$ is the maximum output voltage across the full temperature range ($3.3V + 2\% = 3.366V$)

V_{DO} is the worst case dropout voltage across the full temperature range (600mV)

$I_{OUT(PEAK)}$ is the maximum 3.3V load current

I_{GND} is the regulator ground current.

For our 5A output example:

$$R_{MAX} = \frac{4.75 - (3.366 + 0.6) V}{5 + 0.08 A} = \frac{0.784 V}{5.08 A} = 0.154\Omega$$

The power drop across this resistor is

$$P_{D(RES)} = (I_{OUT(PK)} + I_{GND})^2 \times R$$

or 4.0W. This subtracts directly from the 10.5W of regulator power dissipation that occurs without the resistor, reducing regulator heat generation to 6.5W.

$$P_{D(Regulator)} = P_{D(R = 0\Omega)} - P_{D(RES)}$$

Considering 5% resistor tolerances and standard values leads us to a $0.15\Omega \pm 5\%$ resistor. This produces a nominal power savings of 3.9W. With worst-case tolerances, the regulator power dissipation drops to 6.8W maximum. This heat drop reduces our heat sinking requirements for the MIC29500 significantly. We can use a smaller heat sink with a larger thermal resistance. Now, a heat sink with 8.3°C/W thermal characteristics is suitable—nearly a factor of 2 better than without the resistor. Table 3-10 lists representative heat sinks meeting these conditions.

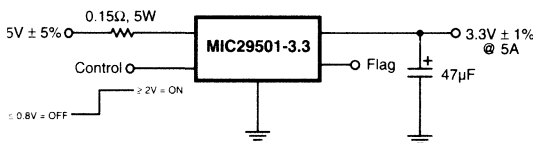

Figure 3-58. Resistor Power Sharing Reduces Heat Sink Requirement

For the 1.5A output application using the MIC29150, we calculate a maximum R of 0.512Ω. Using R = 0.51Ω, at least 1.1W is saved, dropping power dissipation to only 2.0W—a heat sink is probably not required. This circuit is shown in Figure 3-59.

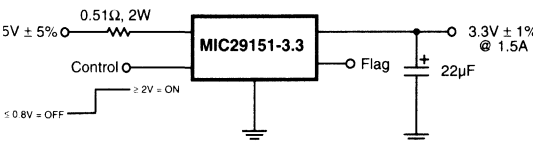

Figure 3-59. Power Sharing Resistor Eliminates Need for Separate Heat Sink

Another option exists for designers of lower current systems. The MIC29150 and MIC29300 regulators are available in the surface mount derivative of the TO-220 package, the TO-263, which is soldered directly to the PC board. No separate heat sink is necessary, as copper area on the board acts as the heat exchanger. For further information, refer to *Heat Sinking Surface Mount Packages*, which follows.

Airflow	Heat Sink Model
400 ft./min. (2m/sec)	AAVID 530700
	AAVID 574802
	Thermalloy 6110
	Thermalloy 7137, 7140
	Thermalloy 7128
300 ft./min. (1.5m/sec)	AAVID 57302
	AAVID 530600
	AAVID 577202
	AAVID 576802
	Thermalloy 6025
	Thermalloy 6109
	Thermalloy 6022
200 ft./min. (1m/sec)	AAVID 575102
	AAVID 574902
	AAVID 523002
	AAVID 504102
	Thermalloy 6225
	Thermalloy 6070
	Thermalloy 6030
	Thermalloy 6230
	Thermalloy 6021, 6221
	Thermalloy 7136, 7138
Natural Convection (no forced airflow)	AAVID 563202
	AAVID 593202
	AAVID 534302
	Thermalloy 6232
	Thermalloy 6032
	Thermalloy 6034
	Thermalloy 6234

Table 3-10. Representative commercial heat sinks for the 5.0A output example using a series dropping resistor. Assumptions: $T_A = 50^\circ\text{C}$, $R = 0.15\Omega \pm 5\%$, $I_{OUT MAX} = 5.0A$, $\theta_{JC} = 2^\circ\text{C/W}$, $\theta_{CS} = 1^\circ\text{C/W}$, resulting in a required $\theta_{SA} = 8.0^\circ\text{C/W}$.

Multiple Packages on One Heat Sink

The previous calculations assume the power dissipation transferred to the heat sink emanates from a single point source. When multiple heat sources are applied, heat sink thermal performance (θ_{SA}) improves. Two mechanisms decrease the total effective thermal resistance:

1. Paralleling multiple devices reduces the effective θ_{JS} .
2. Heat sink efficiency is increased due to improved heat distribution

Paralleled θ_{JC} and θ_{CS} terms lead to a reduction in case temperature of each regulator, since the power dissipation of each semiconductor is reduced proportionally. Distributing the heat sources, instead of a single-point source, minimizes temperature gra-

dients across the heat sink, resulting in lower conduction loss. As much as a 33% reduction in θ_{SA} is possible with distributed heat sources.

Micrel's Super Beta PNP regulators are a natural for multiple package mounting on a single heat sink because their mounting tabs are all at ground potential. Thus, no insulator is needed between the package and the heat sink, allowing the best possible θ_{CS} .

Paralleled Devices on a Heat Sink Example

An example will clarify this concept. Given a regulator that must dissipate 30W of heat, operating at an ambient temperature of 25°C, what heat sink θ_{SA} is needed? Given the following parameters:

$$T_{J(MAX)} = 125^{\circ}C$$

$$\theta_{JC} = 2^{\circ}C/W$$

$$\theta_{CS} = 1^{\circ}C/W$$

Case 1: Single Regulator

This configuration is shown graphically in Figure 3-60.

$$\theta_{SA} = \Delta T/W - (\theta_{JC} + \theta_{CS}) = (125^{\circ} - 25^{\circ}) / 30W - (2 + 1) ^{\circ}C/W$$

$$\theta_{SA} = 0.33^{\circ}C/W$$

This is a very large heat sink.

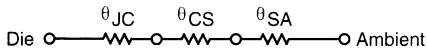

Figure 3-60. Single Heat Source Thermal "Circuit"

Case 2: Two Paralleled Regulators

This configuration is shown graphically in Figure 3-61. The effective θ_{JS} is reduced because the thermal resistances are connected in parallel.

$$\theta_{JC}' = 1 / ((1/\theta_{JC1}) + (1/\theta_{JC2}))$$

Assuming $\theta_{JC1} = \theta_{JC2}$, then

$$\theta_{JC}' = \theta_{JC1} \div 2 = 1^{\circ}C/W$$

$$\theta_{CS}' = 1 / ((1/\theta_{CS1}) + (1/\theta_{CS2}))$$

Assuming $\theta_{CS1} = \theta_{CS2}$, then

$$\theta_{CS}' = \theta_{CS1} \div 2 = 0.5^{\circ}C/W$$

now

$$\theta_{SA} = \Delta T/W - (\theta_{JC}' + \theta_{CS}') = 1.83^{\circ}C/W$$

With the 33% efficiency gain, we could use a heat sink with a θ_{SA} rating as high as 2.4°C/W. This represents a tremendous reduction in heat sink size.

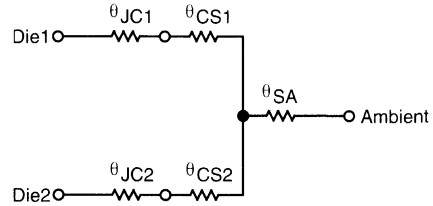

Figure 3-61. Dual Heat Source Thermal "Circuit"

Case 3: Multiple Paralleled Regulators

This configuration is shown graphically in Figure 3-62. For the condition of "n" paralleled heat sources, the θ_{JC} and θ_{CS} are reduced to 1/n their per-unit value. The heat sink needs the following rating:

$$\theta_{SA} = \Delta T/W - ((\theta_{JC1}/n) + (\theta_{CS1}/n))$$

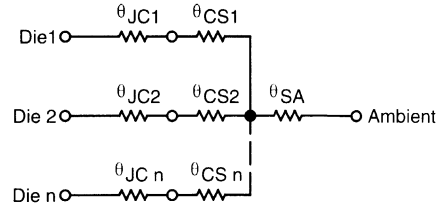

Figure 3-62. "n" Heat Source Thermal Circuit

Table 3-11 shows the reduction in heat sink performance allowed by paralleled regulators.

n	θ_{SA}
1	0.33
2	1.83
3	2.33
4	2.58
5	2.73
6	2.83

Table 3-11. Paralleled Regulators Allow Smaller (Physical Size) Heat Sinks. $T_A = 25^{\circ}C$

Another way of looking at this situation is to ask what is the increase in maximum ambient temperature paralleled regulators allow?

$$T_A = T_{J(MAX)} - W \times [\theta_{SA} + (\theta_{JC}/n) + (\theta_{CS}/n)]$$

Table 3-12 shows the highest allowable T_A using the 0.33°C/W heat sink of Case 1.

n	T_A (°C)
1	25
2	70
3	85
4	92
5	97
6	100

Table 3-12. Highest Allowable Ambient Temperature With a 0.33°C/W Heat Sink

Heat Sinking Surface Mount Packages

System designers increasingly face the restriction of using all surface-mounted components in their new designs—even including the power components. Through-hole components can dissipate excess heat with clip-on or bolt-on heat sinks keeping things cool. Surface mounted components do not have this flexibility and rely on the conductive traces or pads on the printed circuit board for heat transfer. We will address the question “How much PC board pad area does my design require?”

We will determine if a Micrel surface mount low dropout linear regulator may operate using only a PC board pad as its heat sink. We start with the circuit requirements.

System Requirements:

- $V_{OUT} = 5.0V$
- $V_{IN (MAX)} = 9.0V$
- $V_{IN (MIN)} = 5.6V$
- $I_{OUT} = 700mA$
- Duty cycle = 100%
- $T_A = 50^\circ C$

This leads us to choose the 750mA MIC2937A-5.0BU voltage regulator, which has these characteristics:

$$V_{OUT} = 5V \pm 2\% \text{ (worst case over temperature)}$$

$$T_{JMAX} = 125^\circ C$$

$$\theta_{JC} \text{ of the TO-263} = 3^\circ C/W$$

$$\theta_{CS} + 0^\circ C/W \text{ (soldered directly to board)}$$

Preliminary Calculations

$$V_{OUT (MIN)} = 5V - 2\% = 4.9V$$

$$P_D = (V_{IN (MAX)} - V_{OUT (MIN)}) \times I_{OUT} + (V_{IN (MAX)} \times I_{GND})$$

$$= [9V - 4.9V] \times 700mA + (9V \times 15mA) = 3W$$

$$\text{Maximum temperature rise, } \Delta T = T_{J(MAX)} - T_A$$

$$= 125^\circ C - 50^\circ C = 75^\circ C$$

Thermal resistance requirement, θ_{JA} (worst case):

$$\frac{\Delta T}{P_D} = \frac{75^\circ C}{3.0W} = 25^\circ C/W$$

Heat sink thermal resistance

$$\theta_{SA} = \theta_{JA} - (\theta_{JC} + \theta_{CS})$$

$$\theta_{SA} = 25 - (3 + 0) = 22^\circ C/W \text{ (max)}$$

Determining Heat Sink Dimensions

Figure 3-63 shows the total area of a round or square pad, centered on the device. The solid trace represents the area of a square, single sided, horizontal, solder masked, copper PC board trace heat sink, measured in square millimeters. No airflow is assumed. The dashed line shows a heat sink covered in black oil-based paint and with 1.3m/sec (250 feet per minute) airflow. This approaches a “best case” pad heat sink.

Conservative design dictates using the solid trace data, which indicates a pad size of 5000 mm² is needed. This is a pad 71mm by 71mm (2.8 inches per side).

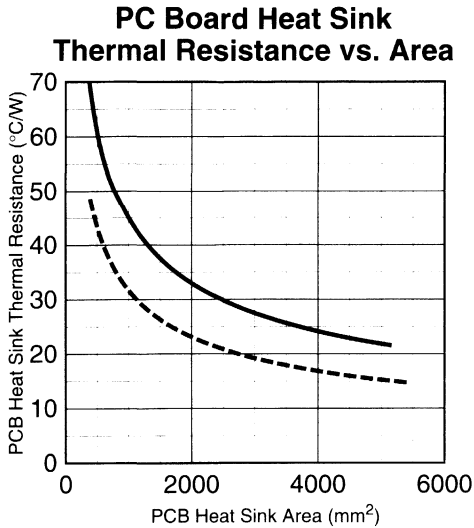

Figure 3-63. Graph to determine PC board area for a given thermal resistance. See text for discussion of the two curves.

Example 2, SO-8 and SOT-223 Package.

Given the following requirements, determine the safe heat sink pad area.

- $V_{OUT} = 5.0V$
- $V_{IN (MAX)} = 14V$
- $V_{IN (MIN)} = 5.6V$
- $I_{OUT} = 150mA$
- Duty cycle = 100%
- $T_A = 50^\circ C$

Your board production facility prefers handling the dual-in-line SO-8 packages whenever possible. Is the SO-8 up to this task? Choosing the MIC2951-03BM, we get these characteristics:

- $T_{J (MAX)} = 125^\circ C$
- θ_{JC} of the SO-8 = $100^\circ C/W$

SO-8 Calculations:

$P_D = [14V - 5V] \times 150mA + (14V \times 8mA) = 1.46W$
 Temperature rise = $125^\circ C - 50^\circ C = 75^\circ C$

Thermal resistance requirement, θ_{JA} (worst case):

$\frac{\Delta T}{P_D} = \frac{75^\circ C}{1.46W} = 51.3^\circ C/W$

Heat sink $\theta_{SA} = 51 - 100 = -49^\circ C/W$ (max)

The negative sign flags the problem: without refrigeration, the SO-8 is not suitable for this application. Consider the MIC5201-5.0BS in a SOT-223 package. This package is smaller than the SO-8, but its three terminals are designed for much better thermal flow. Choosing the MIC5201-3.3BS, we get these characteristics:

$T_{J (MAX)} = 125^\circ C$

θ_{JC} of the SOT-223 = $15^\circ C/W$

$\theta_{CS} = 0^\circ C/W$ (soldered directly to board)

SOT-223 Calculations:

$P_D = [14V - 4.9V] \times 150mA + (14V \times 1.5mA) = 1.4W$

Temperature rise = $125^\circ C - 50^\circ C = 75^\circ C$

Thermal resistance requirement, θ_{JA} (worst case):

$\frac{\Delta T}{P_D} = \frac{75^\circ C}{1.4W} = 54^\circ C/W$

Heat sink $\theta_{SA} = 54 - 15 = 39^\circ C/W$ (max)

Board Area

Referring to Figure 3-63, a pad of $1400mm^2$ (a square pad 1.5 inches per side) provides the required thermal characteristics.

Example 3, SOT-23-5 Package.

A regulator for a cellular telephone must provide 3.6V at 50mA from a battery that could be as high as 6.25V. The maximum ambient temperature is $70^\circ C$ and the maximum desired junction temperature is $100^\circ C$. The minimum-geometry thermal capability of the MIC5205 in the SOT-23-5 is $220^\circ C/W$; must we provide additional area for cooling?

$P_D = [6.25 - 3.56V] \times 50mA + (6.25V \times 0.35mA) = 137mW$

$\frac{\Delta T}{P_D} = \frac{30^\circ C}{0.137W} = 219^\circ C/W$

Which is close enough to 220°C/W θ_{JA} for our purposes. We can use the minimum-geometry layout.

If our electrical or thermal parameters worsened, we could refer to Figure 3-63 and determine the additional copper area needed for heat sinking. Use a value of 130°C/W θ_{JC} for the MIC5205-xxBM5.

Example 4, Measurement of θ_{JA} with a MSOP-8

An MIC5200-3.6BMM (in the 8-pin MSOP package) was soldered to 1oz. double-sided copper PC board material. The board, measuring 4.6 square inches, had its top layer sliced into four quadrants, corresponding to input, output, ground, and enable (see Figure 3-64), and a temperature probe was soldered close to the regulator. The device thermal shutdown temperature was measured at zero power dissipation to give an easy-to-detect temperature reference point. The device was cooled, then the load was increased until the device reached thermal shutdown. By combining T_A , T_J (SHUTDOWN), and P_D , we may accurately determine θ_{JA} as:

$$\theta_{JA} = T_J \text{ (SHUTDOWN)} - T_A \div P_D$$

For a given board size. Next, the board was trimmed to about 2 square inches and retested. Measurements were also taken at 1 and 0.5 square inches. The results are shown in Figure 3-65.

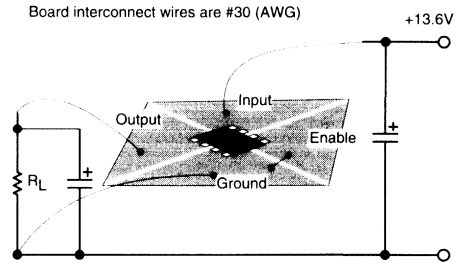

Figure 3-64. MSOP-8 Thermal Resistance Test Jig

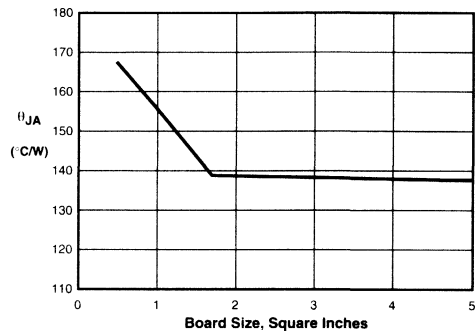

Figure 3-65. Junction to Ambient Thermal Resistance for the MSOP-8 Package

Comments

These formulas are provided as a general guide to thermal characteristics for surface mounted power components. Many estimations and generalizations were made; your system will vary. Please use this information as a rough approximation of board area required and fully evaluate the thermal properties of each board you design to confirm the validity of the assumptions.

Linear Regulator Troubleshooting Guide

Problem	Possible Cause
Output Voltage Low at Heavy Load	Regulator in dropout Excessive lead resistance between regulator and load Regulator in current limit Regulator in thermal shutdown
Output Voltage Bad at Light Load	Regulator in Dropout Minimum output load current not satisfied Input voltage too high (overvoltage shutdown) Layout problem
Regulator Oscillates	Output capacitor too small (Super β PNP) Output capacitor ESR too small Input capacitor bad or missing Layout problems
Regulator Does Not Start	Output polarity reversed Input voltage too high (overvoltage shutdown) Load is shorted or latched up
AC Ripple on Output	Ground loop with input filter capacitor

Solutions to each of these possible causes are presented earlier in this section. If problems persist, please contact Micrel Applications Engineering for assistance.

Section 4. Linear Regulator Solutions

Super β PNP™ Regulators

Micrel's easy to use Super β PNP™ LDO monolithic regulators deliver highly accurate output voltages and are fully protected from fault conditions. Their maximum output currents range from 80mA to 7.5A. They are available in numerous fixed voltages, and most families offer adjustable versions.

Micrel's monolithic linear regulator family appears below, listed by increasing output current capability.

- MIC5230 — 10mA regulator with 1 μ A operating quiescent current
- MIC5203 — 80mA regulator in the tiny SOT-143 package. Fixed output voltages of 2.85, 3.0, 3.3, 3.6, 3.8, 4.0, 4.75, and 5.0V are available.
- LP2950 — 100mA fixed 3.3, 4.85, and 5.0V regulator available in the TO-92 package
- LP2951 — 100mA fixed 5.0V and adjustable regulator available in the SO-8 package
- MIC5200 — 100mA regulator available in SO-8 and SOT-223 packages. Fixed output voltages of 3.0, 3.3, 4.85, and 5.0V are available.
- MIC5202 — dual 100mA version of the '5200, available in the SO-8 package.
- MIC5205 — 150mA low-noise fixed and adjustable regulator supplied in the small SOT-23-5 package
- MIC5206 — 150mA low-noise regulator supplied in the small SOT-23-5 or MSOP-8 package
- MIC5207 — 180mA low-noise regulator supplied in the small SOT-23-5 package
- MIC2950 — 150mA fixed 3.3, 4.85, and 5.0V regulator available in the TO-92 package
- MIC2951 — 150mA fixed 5.0V and adjustable regulator available in the SO-8 package
- MIC5201 — 200mA regulator available in SO-8 and SOT-223 packages. Fixed output voltages of 3.0, 3.3, 4.85, and 5V, plus an adjustable version are available.
- MIC2920A — family of 400mA regulators in TO-220, TO-263-3, SOT-223, and SO-8 packages. Fixed output voltages of 3.3V, 4.85V, 5V, and 12V plus three adjustable versions are available.
- MIC2937A — family of 750mA regulators in TO-220 and TO-263 packages. Fixed output voltages of 3.3V, 5V, and 12V, plus two adjustable versions are available.
- MIC2940A — 1250mA regulators in TO-220 and TO-263 packages with fixed output voltages of 3.3V, 5V, and 12V. The MIC2941A is an adjustable version.
- MIC29150 — family of 1.5A regulators in TO-220 and TO-263 packages. Fixed output voltages of 3.3V, 5V, and 12V, plus two adjustable versions are available.
- MIC29300 — family of 3A regulators in TO-220 and TO-263 packages. Fixed output voltages of 3.3V, 5V, and 12V, plus two adjustable versions are available.
- MIC29310 — low-cost 3A regulator with 3.3 and 5V fixed outputs in a TO-220 package. The MIC29312 is an adjustable version.
- MIC29500 — family of 5A regulators in TO-220, and TO-263 packages. Fixed output voltages of 3.3V and 5V, plus two adjustable versions are available.
- MIC29510 — low-cost 5A regulator with 3.3 and 5V fixed outputs in a TO-220 package. The MIC29512 is an adjustable version.
- MIC29710 — low-cost 7.5A regulator with 3.3 and 5V fixed outputs in a TO-220 package. The MIC29712 is an adjustable version.
- MIC29750 — 7.5A regulator in a TO-247 power package with 3.3 and 5V fixed outputs. The MIC29752 is an adjustable version.

Micrel's medium and high-current regulators (400mA and higher output current capability) have a part numbering code that denotes the additional features offered. The basic family number, ending in "A" or "0" denotes the easy-to-use three-pin fixed voltage regulator.

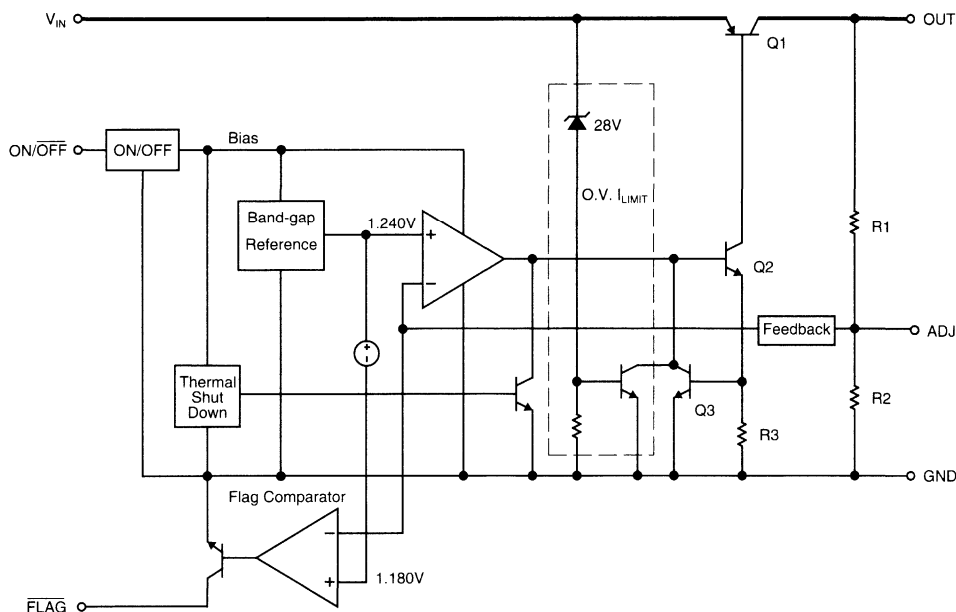

Figure 4-1. Super Beta PNP™ Regulator Simplified Schematic Diagram

- Part numbers ending in “1” are five-pin fixed devices with a digital control pin for turning the regulator ON or OFF and an Error Flag output that signals when the output is not in regulation.
- Part numbers ending in “2” are adjustable parts with ON/OFF control
- Devices ending with “3” are adjustables with an Error Flag

Super beta PNP Circuitry

The simplified schematic diagram of Micrel’s medium and high current monolithic LDOs appears as Figure 4-1. The high current path from input to output through the pass transistor is in bold. The bandgap reference and all other circuitry is powered via the Enable Circuit, which allows for “zero” current draw when disabled. The reference voltage is compared to the sampled output voltage fed back by R1 and R2. If this voltage is less than the bandgap reference, the op amp output increases. This increases the current through driver transistor Q2, which pulls down on the base of Q1, turning it on harder. If Q1’s base current rises excessively, the voltage drop across R3 enables Q3, which in turn limits the current through Q2. Die temperature is monitored, and if it becomes

excessive, the thermal shutdown circuit activates, clamping the base of Q2 and shutting down Q1. The flag circuit looks at the output voltage sample and compares it to a reference set 5% lower. If the sample is even lower, the flag comparator saturates the open collector flag transistor, signaling the fault condition.

Dropout Voltage

The Super beta PNP family of low-dropout regulators offers typical dropout voltages of only 300mV across the output current range. This low dropout is achieved by using large and efficient multicelled PNP output transistors, and operating them in their high-beta range well below their capacity. Dropout voltage in the Super beta PNP regulators is determined by the saturation voltage of the PNP pass element. As in all bipolar transistors, the saturation voltage is proportional to the current through the transistor. At light loads, the dropout voltage is only a few tens of millivolts. At moderate output currents, the dropout rises to 200 to 300mV. At the full rated output, the typical dropout voltage is approximately 300mV for most of the families. Lower cost versions have somewhat higher dropout at full load, generally in the 400 to

500mV range. The data sheet for each device graphs typical dropout voltage versus output current.

Ground Current

Micrel's Super β PNP process allows these high current devices to maintain very high transistor beta—on the order of 100 at their full rated current. This contrasts with competitive PNP devices that suffer with betas in the 10 to 30 range. This impacts regulator designs by reducing wasteful ground current. Micrel's beta of 100 translates into typical full load ground currents of only 1% of your output. The data sheet for each device graphs typical ground current versus output current.

When linear regulators approach dropout, generally due to insufficient input voltage, base drive to the pass transistor increases to fully saturate the transistor. With some older PNP regulators, the ground current would skyrocket as dropout approached. Micrel's Super β PNP regulators employ saturation detection circuitry which limits base drive when dropout-induced saturation occurs, limiting ground current.

Fully Protected

Micrel regulators are survivors. Built-in protection features like current limiting, overtemperature shutdown, and reversed-input polarity protection allow LDO survival under otherwise catastrophic situations. Other protection features are optionally available, such as overvoltage shutdown and a digital error flag.

Current Limiting

Current limiting is the first line of defense for a regulator. It operates nearly instantaneously in the event of a fault, and keeps the internal transistor, its wire bonds, and external circuit board traces from fusing in the event of a short circuit or extremely heavy output load. The current limit operates by linearly clamping the output current in case of a fault. For example, if a MIC29150 with a 2A current limit encounters a shorted load, it will pass up to 2A of current into that load. The resulting high power dissipation (2A multiplied by the entire input voltage) causes the regulator's die temperature to rise, triggering the second line of defense, overtemperature shutdown.

Overtemperature Shutdown

As the output fault causes internal dissipation and die temperature rise, the regulator approaches its operating limits. At a predetermined high temperature, the regulator shuts off its pass element, bringing output current and power dissipation to zero. The hot die begins cooling. When its temperature drops below an acceptable temperature threshold, it automatically re-enables itself. If the load problem has been addressed, normal operation resumes. If the short persists, the LDO will begin sourcing current, will heat up, and eventually will turn off again. This sequence will repeat until the load is corrected or input power is removed. Although operation at the verge of thermal shutdown is not recommended, Micrel has tested LDOs for several million ON/OFF thermal cycles without undue die stress. In fact, during reliability testing, regulators are burned-in at the thermal shutdown-cycle limit.

Reversed Input Polarity

Protection from reversed input polarity is important for a number of reasons. Consumer products using LDOs with this feature survive batteries inserted improperly or the use of the wrong AC adapter. Automotive electronics must survive improper jump starting. All types of systems should last through initial production testing with an incorrectly inserted (backward) regulator. By using reversed input protected regulators, both the regulator and its load are protected against reverse polarity, which limits reverse current flow.

This feature may be simulated as an ideal diode, *with zero forward voltage drop*, in series with the output. Actually, a small current flows from the input pin to ground through the voltage divider network, but this may generally be neglected. Measured data from Super β PNP regulators with a 100 Ω resistor from output to ground follows:

<u>Input Voltage (V)</u>	<u>Load Current (mA)</u>
0	0
-5	0
-10	0
-15	-2.0
-20	-6.9
-25	-7.8
-30	-14

Although the devices were tested to -30V for this table without any failure, the reverse-polarity specification ranges only to -20V.

Overvoltage Shutdown

Most Micrel LDOs feature overvoltage shutdown. If the input voltage rises above a certain predetermined level, generally between 35V and 40V, the control circuitry disables the output pass transistor. This feature allows the regulator to reliably survive high voltage (60V or so—see the device data sheet for the exact limit) spikes on the input regardless of output load conditions. The automotive industry calls this feature “Load-Dump Protection”¹ and it is crucial to reliability in automotive electronics.

Many of Micrel’s regulator families offer a version with a digital error flag output. The error flag monitors the output voltage and pulls its open collector (or drain) output low if the voltage is too low. The definition of “too low” ranges from about –5% to –8% below nominal output, depending upon the device type. The flag comparator is unaffected by low input voltage or a too-light or too-heavy load (although a too-heavy load generally will cause the output voltage to drop, triggering the flag).

Variety of Packages

From the tiny SOT-143 to the large TO-247 (also known as the TO-3P), Micrel Super Beta PNP regulators span orders of magnitude in both size and output current.

Why Choose Five Terminal Regulators?

What do the extra pins of the five pin linear regulators provide? After all, three terminal regulators give Input, Output, and Ground; what else is necessary? Five terminal devices allow the system designer to monitor power quality to the load and digitally switch the supply ON and OFF. Power quality is indicated by a flag output. When the output voltage is within a few percent of its desired value, the flag is high, indicating the output is good. If the output drops, because of either low input voltage to the regulator or an over-current condition, the flag drops to signal a fault condition. A controller can monitor this output and make decisions regarding the system’s readiness. For example, at initial power-up, the flag will instantaneously read high (if pulled up to an external supply), but as soon as the input supply to the regulator reaches about 2V, the flag pulls low. It stays low until the regulator output nears its desired value. With the

NOTE 1: A “load dump” fault occurs in an automobile when the battery cable breaks loose and the unfiltered alternator output powers the vehicle.

MIC29150 family of low-dropout linear regulators, the flag rises when the output voltage reaches about 97% of the desired value. In a 3.3V system, the flag indicates “output good” with $V_{OUT} = 3.2V$.

Logic-compatible power control allows “sleep” mode operation and results in better energy efficiency. The ENABLE input of the MIC29150 family is TTL and 5V or 3.3V CMOS compatible. When this input is pulled above approximately 1.4V, the regulator is activated. A special feature of this regulator family is *zero power consumption* when inactive. Whenever the logic control input is low, all internal circuitry is biased OFF. (A tiny leakage current, measured in nanoamperes, may flow).

Three terminal regulators are used whenever ON/OFF control is not necessary and no processing power is available to respond to the flag output information. Three terminal regulators need only a single output filter capacitor minimizing design effort. Micrel three-terminal regulators all are fixed-output voltage devices with the same pin configuration: input, ground, output.

Five terminal regulators provide all the functionality of three pin devices PLUS allow power supply quality monitoring and ON/OFF switching for “sleep” mode applications.

Compatible Pinouts

Micrel’s MIC29150/29300/29500 and MIC29310/29510/29710 families of low-dropout regulators have identical pinouts throughout the line. A single board layout accommodates from 1.5A through 7.5A of maximum current, simply by replacing one LDO with another of different rating. Additionally, the three pin and five pin versions of these two families have a similarity that allows a three pin regulator to function in a socket designed for a five pin version.

Three Pin Regulator	Five Pin Regulator
—	Enable or Flag
Input	Input
Ground	Ground
Output	Output
—	Adjust or Flag

Many applications do not require the ENABLE or FLAG functions. In these cases, if a fixed voltage is suitable, a three pin LDO may be substituted in the

five pin socket by simply leaving the outer holes open. Use care when forming the leads; gently bend them 90° before compressing them. The plastic may crack if the leads are forced excessively.

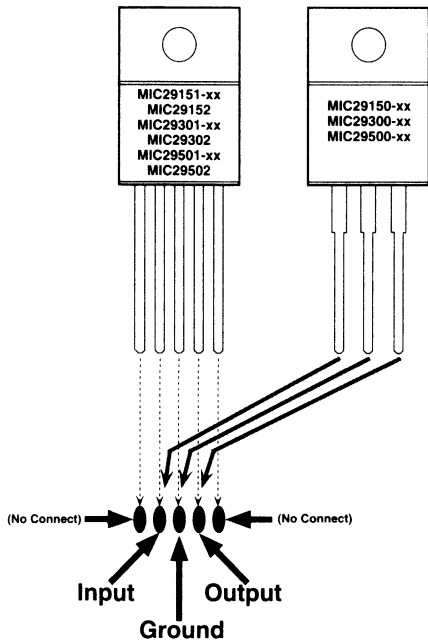

Figure 4-2, PC Board Layout for 5-Pin and 3-Pin Regulators

Stability Issues

PNP output regulators require a minimum value of output filter capacitance for stability. The data sheet for each device specifies the minimum value of output capacitor necessary.

A stability analysis of the PNP regulators shows there are two main poles, one low internal pole at about 10Hz, and an external pole provided by the output filter capacitor. An internal zero of approximately 1.5kHz cancels the internal pole, leaving the output capacitor to provide the dominant pole for stability. Gain/phase characteristics are affected by several parameters:

- Internal design (compensation and configuration)
- Load capacitor value
- Load capacitor ESR
- Load current
- Output transistor beta
- Driver stage transconductance

Stray capacitance on the feedback pins of adjustable regulators serves to decrease the phase margin. Circuits designed for minimum output noise often intentionally add capacitance across a feedback resistor, which couples back to the feedback pin. Increasing the size of the output filter capacitor in this situation recovers the phase margin required for stability.

Paralleling Bipolar Regulators

The most difficult aspect of using linear regulators is heat sinking. As output current and/or input-to-output voltage differential increases, the heat sink size rapidly increases. One method of mitigating this is to split the heat into more than one point source. In **Section 3, Thermal Management**, using a resistor to dissipate excess power when the input voltage is much higher than the desired output was discussed, but this technique is unusable when we need low system dropout. Another method of power sharing is to parallel the regulators. This preserves their low dropout characteristics and also allows scaling to higher output currents. As also shown in *Thermal Management*, heat sinking two devices is up to 33% more efficient than sinking one at the same overall power level.

Bipolar transistors have a negative temperature coefficient of resistance; as they get hotter, they pass more current for a given voltage. This characteristic makes paralleling bipolar transistors difficult—if the transistors are not precisely matched and at identical temperatures, one will draw more current than the others. This transistor will thereby get hotter and draw even more current. This condition, known as thermal runaway, prevents equal current sharing between devices and often results in the destruction of the hot-test device.

We may parallel bipolar transistors if we monitor the current through each of the devices and somehow force them to be equal. An easy and accurate method is by using current sense resistors and op amps. Figure 4-3 shows two 7.5A MIC29712 in parallel to produce a 15A composite output. One regulator is chosen as the master. Its output is adjusted to the desired voltage in the usual manner with two resistors. A small-value sense resistor samples the output for the op amp. The resistor value is chosen to provide an output voltage large enough to swamp the input offset voltage (V_{OS}) of the op amp with medium output current. If the resistor is too small, matching will be poor; if it is too large, system dropout voltage

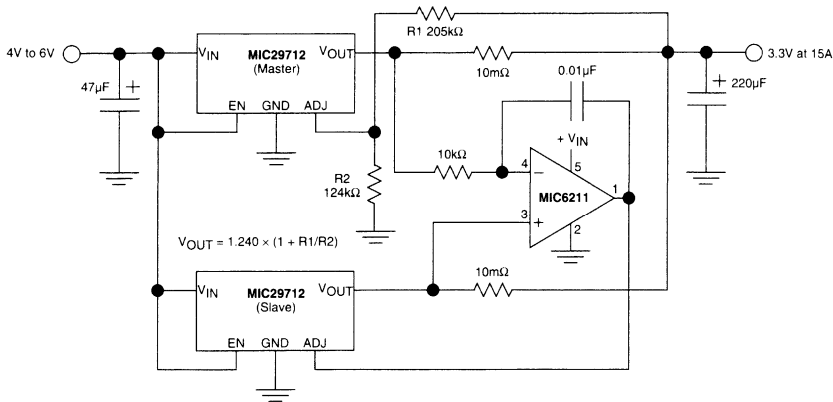

Figure 4-3. Two Super Beta PNP Regulators in Parallel.

will increase. The op amp drives the ADJ input of the slave regulator and matches its output to the master.

This technique is also applicable to three or more paralleled regulators: Figure 4-4 shows three in parallel. This may be extended to any number of devices by merely adding a sense resistor and op amp circuit to each additional slave regulator.

Although a fixed regulator can be used as a master, this is not recommended. Load regulation suffers because fixed output regulators (usually) do not have a separate SENSE input to monitor load voltage. As current through the sense resistor increases, the output voltage will drop because voltage sensing occurs on the wrong side of the current sense resistor.

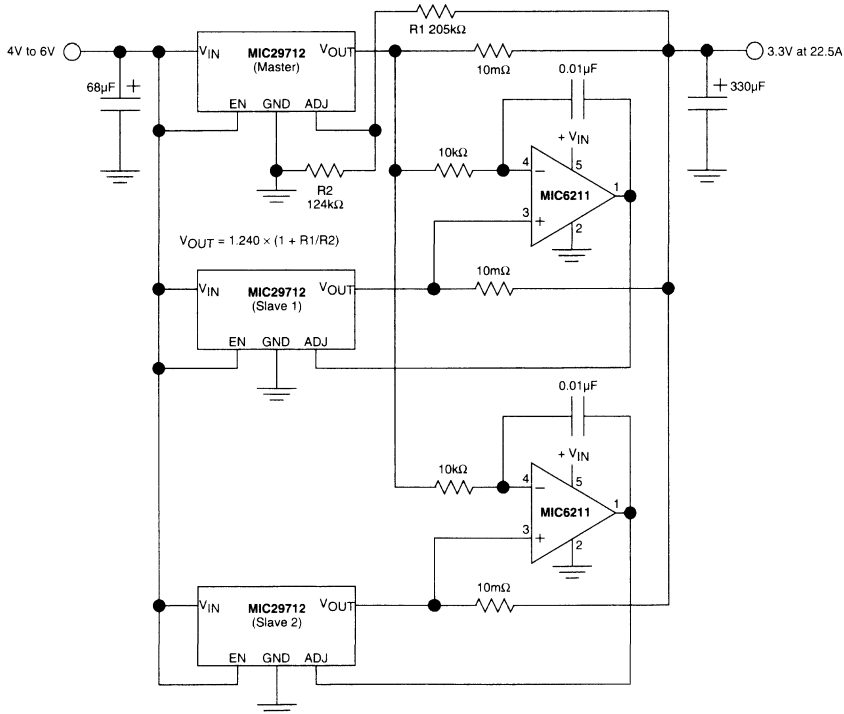

Figure 4-4. Three or More Parallel Super Beta PNP Regulators

Micrel's Unique "Super LDO™"

The Super LDO™ is a dedicated control IC to drive an external N-channel MOSFET pass element. It allows economical management of moderate to high output currents.

The external pass element offers the designer three advantages unattainable with the monolithic approach: First, because the control circuitry is separate, the pass element's die area in a given package can be increased. This results in lower dropout voltages at higher output currents. Second, the junction-to-case thermal resistance is much less allowing higher output currents before a heat sink is required. Third, the semiconductor process for manufacturing MOSFETs is simpler and less costly than the process needed to fabricate accurate voltage references and analog comparators. High current monolithic regulators have most of their die area dedicated to the output device; why build a large, relatively simple device on an expensive process? The Super LDO combines all three advantages to produce a high performance, low cost regulating system.

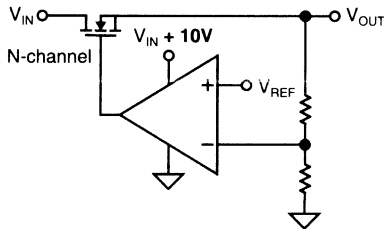

Figure 4-5. N-Channel Regulator

The most attractive device for the external pass element is the N-channel power MOSFET (see Figure 4-5). Discrete N-channel MOSFET prices continue to decrease (due to high volume usage), and the race for lower and lower ON resistance works in your favor. The N-channel MOSFET, like the P-channel MOSFET, reduces ground current. With device ON resistance now below 10mΩ, dropout voltages below 100mV are possible with output currents in excess of 10A. Even lower dropouts are possible by using two or more pass elements in parallel.

Unfortunately, full gate-to-source enhancement of the N-channel MOSFET requires an additional 10V to 15V above the required output voltage. Controlling the MOSFET's gate using a second higher volt-

age supply requires additional circuitry and is clumsy at best.

Micrel's Super LDO Family

Micrel's Super LDO Regulator family consists of three regulators which control an external N-channel MOSFET for low dropout at high current. Two members of the family internally generate the required higher MOSFET enhancement voltage, while the other relies on an existing external supply voltage.

All members of the Super LDO Regulator family have a 35mV current limit threshold, ±2% nominal output voltage setting, and a 3V to 36V operating voltage range. All family members also include a TTL compatible enable/shutdown input (EN) and an open collector fault output (FLAG). When shutdown (TTL low), the device draws less than 1μA. The FLAG output is low whenever the output voltage is 6% or more below its nominal value.

The MIC5156

The MIC5156 Super LDO Regulator occupies the least printed circuit board space in applications where a suitable voltage is available for MOSFET gate enhancement. To minimize external parts, the MIC5156 is available in fixed output versions of 3.3V or 5V. An adjustable version is also available which uses two external resistors to set the output voltage from 1.3V to 36V.

The MIC5157 and MIC5158

For stand-alone applications the MIC5157 and MIC5158 incorporate an internal charge-pump voltage tripler to supply the necessary gate enhancement for an external N-channel MOSFET. Both devices can fully enhance a logic-level N-channel MOSFET from a supply voltage as low as 3.0V. Three inexpensive small value capacitors are required by the charge pump.

The MIC5157 output voltage is externally selected for a fixed output voltage of 3.3V, 5V or 12V.

The MIC5158 output voltage is externally selectable for either a fixed 5V output or an adjustable output. Two external resistors are required to set the output voltage for adjustable operation.

3.3V, 10A Regulator Application

Figure 4-6 shows the MIC5157's ability to supply the additional MOSFET gate enhancement in a

low dropout 3.3V, 10A supply application. Capacitors C1 and C2 perform the voltage tripling required by the N-channel logic-level MOSFETs. Improved response to load transients is accomplished by using output capacitors with low ESR characteristics. The exact capacitance value required for a given design depends on the maximum output voltage disturbance that can be tolerated during a worse case load change. Adding low-value (0.01µF to 0.1µF) film capacitors (such as Wima MKS2 series) near the load will also improve the regulator's transient response.

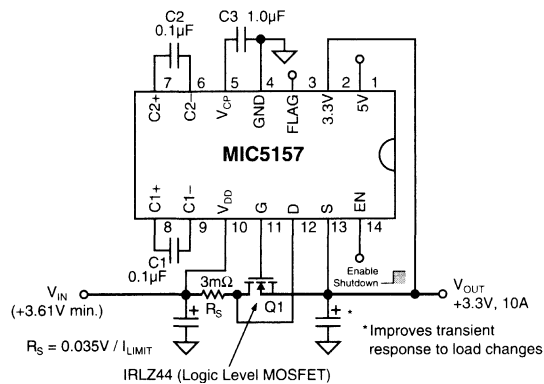

Figure 4-6. 10A Linear Regulator

Comparison With Monolithics

Similarities to Monolithics

Like Micrel's Super Beta PNP monolithic regulators, the Super LDO is a linear regulator. It provides a regulated and filtered output voltage from a (at least) slightly higher input source; it does not require inductors; it is available in fixed as well as user-adjustable output voltages; and it protects itself and its load by implementing current limiting. There are significant differences between the Super LDO and monolithic designs, however.

Differences from Monolithics

The differences between the Super LDO and monolithic designs is depicted in Table 4-1. The external N-channel MOSFET required by the Super LDO gives it great flexibility—by simply selecting the MOSFET, the designer may choose output current capability as well as dropout voltage. You may customize your regulator for your exact needs: the dropout voltage is simply $V_{DO} = I \times R_{DS\ ON}$ and the current limit is adjustable by selecting one resistor. Also, by placing the hot pass element away from the sensitive refer-

ence and voltage comparators, better performance over the operating temperature range and much higher output currents are possible.

The Super LDO does not offer thermal shutdown protection and the pass MOSFET's tab is V_{OUT} instead of ground, unlike the Super beta PNP versions.

Above approximately 5A, the Super LDO is generally the most economical regulation solution.

Super LDO	Monolithic LDO
"Any" output current	Output current set by die size
Adjustable current limit	Fixed Current limit
User-selectable dropout voltage	Dropout voltage set by die size
Better stability than PNP LDOs	
Reference temperature independent of hot pass element	Reference gets hot
Pass transistor tab is V_{OUT}	Tab is grounded
No thermal shutdown	Thermal shutdown
Multiple component solution	Only capacitors needed

Table 4-1. Super LDO and Monolithic Regulator Comparison

Unique Super LDO Applications

Super High-Current Regulator

Figure 4-7 shows a linear regulator offering output current to 30A with a dropout voltage of only 330mV. Current limit is set to 45A. With proper cooling and current-limit resistor changes, this circuit scales to any arbitrary output current: 50A, 100A— you name it!

Achieving the heat sinking required for the high current output mentioned above is difficult. As output current and/or input-to-output voltage differentials increase, the heat sink size rapidly increases. One technique to ease the heat sinking problem is to split the heat generators into multiple sources—by using multiple pass MOSFETs in parallel.

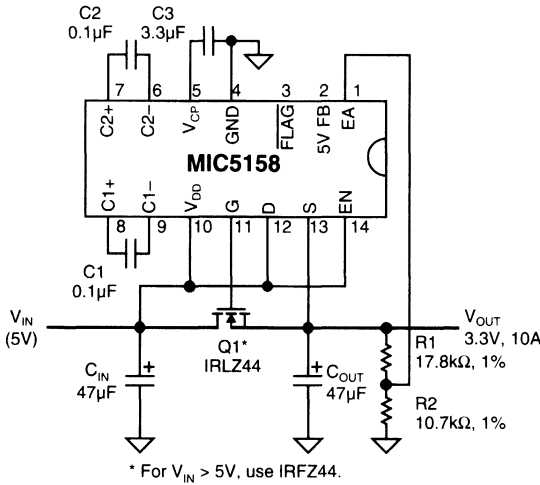

* For $V_{IN} > 5V$, use IRFZ44.

Figure 4-7. A High Current Regulator Using the MIC5158

Unlike bipolar transistors, MOSFETs have a negative temperature coefficient of resistance. This makes them easier to parallel than bipolars. The MOSFET carrying more current heats up; the heat increases the channel resistance, reducing the current flow through that FET.

Unfortunately for Super LDO applications, the MOSFET threshold voltage varies from part-to-part and over the operating temperature range. Unlike power switching applications, Super LDO linear regulator operation of the pass MOSFET is in the linear region, which is at or just above the threshold. This means device-to-device threshold voltage variation causes mismatch.

If two MOSFETs are mounted on the same heat sink, it is possible to directly parallel them in less demanding applications where the maximum output current is within the rating of a single device and total power dissipation is close to that possible with a single unit.

A better solution, usable with two or more MOSFETs in parallel, is to use ballast resistors in series with the source lead (output). Size the ballast resistors to drop a voltage equal to or a bit larger than the worst-case gate-to-source threshold voltage variation. As current flow through one MOSFET and ballast resistor increases, the ballast resistor voltage drop reduces MOSFET V_{GS} , increasing its resistance. This

reduces current flow through that MOSFET. Figure 4-8 shows an example of this technique.

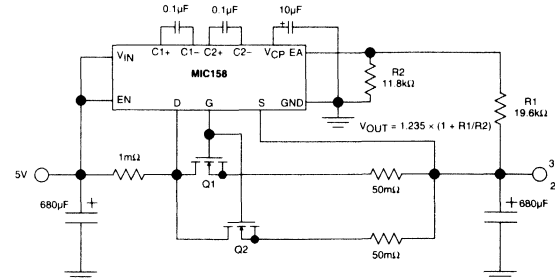

Figure 4-8. Ballast Resistors Promote Current Sharing With Parallel MOSFETs

Lower dropout voltage and even better matching is possible using op amps to force sharing. A low current drain op amp may be powered by the V_{CP} pin of the MIC5157 or MIC5158, as shown in Figure 4-9.

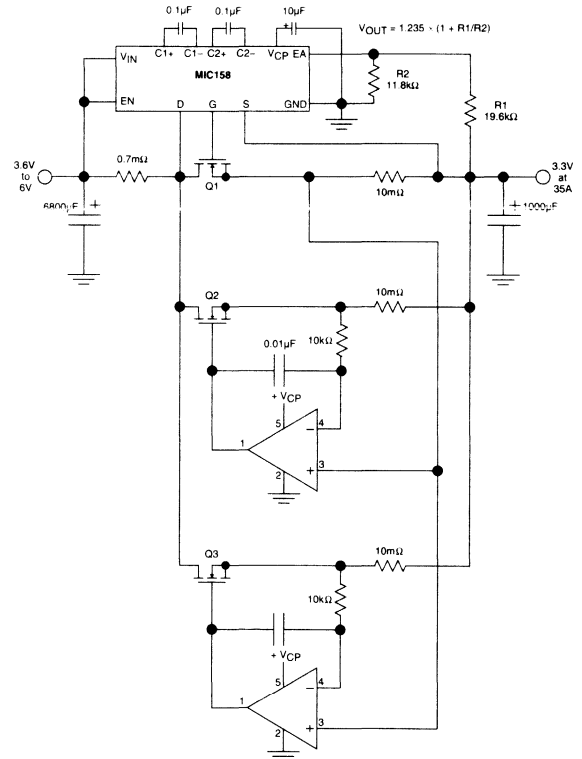

Figure 4-9. Parallel MOSFETs for High Current and/or High Power Dissipation Regulators

Selecting the Current Limit Threshold

By choosing one resistor value, the current limit threshold of the Super LDO is set. The resistor is chosen to drop 35mV at the desired output current limit value. While discrete resistors may be used, a more economical solution is often a length of copper wire or PC board trace used as the current sense resistor. The wire diameter or the width of the copper trace must be suitable for the current density flowing through it, and its length must provide the required resistance.

Sense Resistor Power Dissipation

The power dissipation of sense resistors used in Super LDO regulator circuits is small and generally does not require the power dissipation capability found in most low-value resistors.

Kelvin Sensing

A Kelvin, or four-lead, connection is a measurement connection that avoids the error caused by voltage drop in the high-current path leads.

Referring to Figure 4-10, sense leads are attached directly across the resistance element—intentionally excluding the power path leads. Because the sense conductors carry negligible current (sense inputs are typically high impedance voltage measurement inputs), there is no voltage drop to skew the $E = I \times R$ measurement.

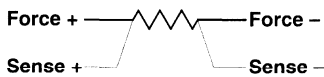

Figure 4-10. A Kelvin-sense Resistor

Manufacturers of Kelvin-sensed resistors are listed in the References section.

Alternative Current Sense Resistors

A low-value resistor can be made from a length of copper magnet wire or from a printed circuit board trace. Tables 4-2, 4-3, and 4-4 are provided for wire and printed circuit traces.

Copper has a positive temperature coefficient of resistivity of +0.39%/°C. This can be significant when higher-accuracy current limiting is required.

A Kelvin connection between the sense element and the Super LDO Regulator Controller improves the accuracy of the current limit set-point.

Table 4-2. Copper Wire Resistance

AWG Wire Size	Resistance at 20°C	
	10 ⁻⁶ Ω/cm	10 ⁻⁶ Ω/in
10	32.70	83.06
11	41.37	105.1
12	52.09	132.3
13	65.64	166.7
14	82.80	210.3
15	104.3	264.9
16	131.8	334.8
17	165.8	421.1
18	209.5	532.1
19	263.9	670.3
20	332.3	844.0
21	418.9	1064.0
22	531.4	1349.8
23	666.0	1691.6
24	842.1	2138.9
25	1062.0	2697.5
26	1345.0	3416.3
27	1687.6	4286.5
28	2142.7	5442.5
29	2664.3	6767.3
30	3402.2	8641.6
31	4294.6	10908.3
32	5314.9	13499.8
33	6748.6	17141.4
34	8572.8	21774.9
35	10849	27556.5
36	13608	34564.3
37	16801	42674.5
38	21266	54015.6
39	27775	70548.5
40	35400	89916.0
41	43405	110248.7
42	54429	138249.7
43	70308	178582.3
44	85072	216082.9

Overcurrent Sense Resistors from PC Board Traces

Building the resistor from printed-circuit board (PCB) copper is attractive; arbitrary values can be provided inexpensively. The ever-shrinking world of electronic assemblies requires minimizing the physical size of this resistor which presents a power-dissipation issue. Making the resistor too small could cause excessive heat rise, leading to PCB trace damage or destruction (i.e., a fuse rather than a controlled resistor).

Table 4-3 Printed Circuit Copper Resistance

Conductor Thickness	Conductor Width (inches)	Resistance mΩ/in
0.5oz/ft ² (18μm)	0.025	39.3
	0.050	19.7
	0.100	9.83
	0.200	4.91
	0.500	1.97
1 oz/ft ² (35μm)	0.025	19.7
	0.050	9.83
	0.100	4.91
	0.200	2.46
	0.500	0.98
2oz/ft ² (70μm)	0.025	9.83
	0.050	4.91
	0.100	2.46
	0.200	1.23
	0.500	0.49
3oz/ft ² (106μm)	0.025	6.5
	0.050	3.25
	0.100	1.63
	0.200	0.81
	0.500	0.325

$$(4-3) \quad l = \frac{w R}{\rho_s(T)}$$

where:

l = resistor length (mils)

w = resistor width (mils)

R = desired resistance (Ω)

$\rho_s(T)$ = sheet resistance at elevated temp. (Ω/□)

PCB Weight (oz/ft ²)	Copper Trace Height	
	(mils)	(μm)
1/2	0.7	17.8
1	1.4	35.6
2	2.8	71.1
3	4.2	106.7

Table 4-4. Copper Trace Heights

Resistor Design Method

Three design equations provide a resistor that occupies the minimum area. This method considers current density as it relates to heat dissipation in a surface layer resistor.

$$(4-1) \quad \rho_s(T) = \frac{\rho [1 + \alpha (T_A + T_{RISE} - 20)]}{h}$$

where:

- $\rho_s(T)$ = sheet resistance at elevated temp. (Ω/□)
- $\rho = 0.0172$ = copper resistivity at 20°C (Ω • μm)
- $\alpha = 0.00393$ = temperature coefficient of ρ (per °C)
- T_A = ambient temperature (°C)
- T_{RISE} = allowed temperature rise (°C)
- h = copper trace height (μm, see Table 4-4)

$$(4-2) \quad w = \frac{1000 I_{MAX}}{\sqrt{\frac{T_{RISE} + \theta_{SA}}{\rho_s(T)}}}$$

where:

- w* = minimum copper resistor trace width (mils)
- I_{MAX} = maximum current for allowed T_{RISE} (A)
- T_{RISE} = allowed temperature rise (°C)
- θ_{SA} = resistor thermal resistance (°C × in²/W)
- $\rho_s(T)$ = sheet resistance at elevated temp. (Ω/□)
- Note: $\theta_{SA} \approx 55 \text{ °C} \cdot \text{in}^2/\text{W}$

Design Example

Figure 4-11 is a circuit designed to produce a 3.3V, 10A output from a 5V input. Meeting the design goal of occupying minimal PC board space required minimizing sense resistor area. This resistor is shown as R_S .

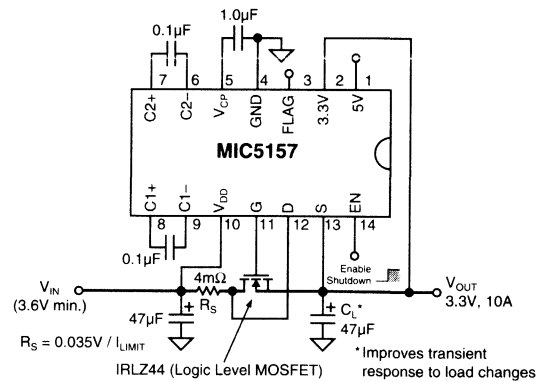

Figure 4-11. Regulator Circuit Diagram

The 4mΩ current-sensing resistor (R_S) of Figure 4-11 is designed as follows: (1) based on copper trace height and an allowed temperature rise for the resistor, calculate the sheet resistance using Equation 4-1; (2) based on the maximum current the resistor will have to sustain, calculate its minimum trace width using Equation 4-2; and (3) based on the desired resistance, calculate the required trace length using Equation 4-3.

Calculate Sheet Resistance

This design uses 1 oz/ft² weight PCB material, which has a copper thickness (trace height) of 35.6µm. See Table 4-4. Allowing the resistor to produce a 75°C temperature rise will place it at 100°C (worst case) when operating in a 25°C ambient environment:

$$\rho_s(T) = 635 \times 10^{-6} \Omega = 0.635 \text{ m}\Omega/\square.$$

Calculate Minimum Trace Width

The design example provides an output current of 5A. Because of resistor tolerance and the current-limit trip-point specification of the MIC5158 (0.028 to 0.042V), a trip-point of 8.75A is chosen, allowing for as much as 10A of current during the sustained limiting condition:

$$w = 215.8 \text{ mils} \approx 216 \text{ mils}.$$

Calculate Required Trace Length

The length of a 4mΩ resistor is determined via Equation 4-3 as follows:

$$l = 1360.6 \text{ mils} \approx 1361 \text{ mils}.$$

Resistor Layout

To avoid errors caused by voltage drops in the power leads, the resistor should include Kelvin sensing leads. Figure 4-12 illustrates a layout incorporating Kelvin sensing leads.

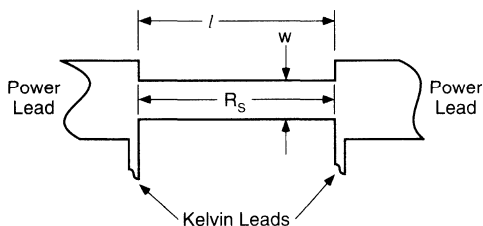

Figure 4-12. Typical Kelvin Resistor Layout

Thermal Considerations

The previous equations produce a resistance of the desired value at *elevated temperature*. It is important to consider resistance at temperature because copper has a high temperature coefficient. This design method is appropriate for current-sensing resistors because their accuracy should be optimized for the current they are intended to sense.

Resistor Dimensions Spreadsheet

A spreadsheet is available to ease the calculation process. Its source code, in Lotus 1-2-3 format, is available via e-mail from Micrel. Send a message to apps@micrel.com requesting "SENSE RES.WK1"

Design Aids

Table 4-4 provides an input needed for Equation 4-1 (trace height), and Figure 3-63 [from Section 3, *Thermal Management*] indicates that 1 in² (645 mm²) of solder-masked copper in still air has a thermal resistance of 55°C/W. Different situations; e.g., internal layers or plated copper, will have different thermal resistances. Other references include MIL-STD-275E: *Printed Wiring for Electronic Equipment*.

Highly Accurate Current Limiting

Improving upon the accuracy of the current limit mechanism is possible. Refer to Section 3 for a description of using the Super LDO as a highly accurate adjustable current source.

Protecting the Super LDO from Long-Term Short Circuits

Foldback current limiting is a useful feature for regulators like the Super LDO that do not have over-temperature shutdown.

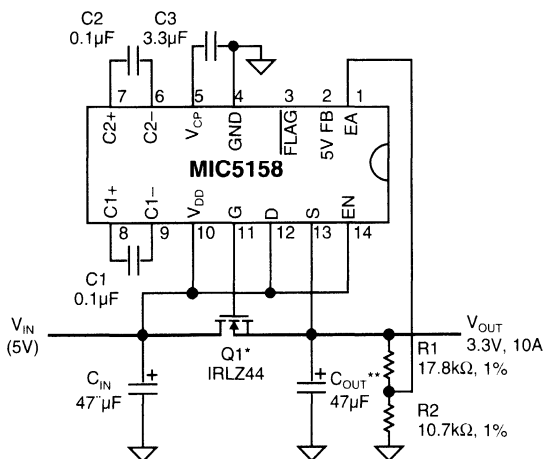

* For V_{IN} > 5V, use IRLZ44.

** Improves transient response to load changes.

Figure 4-13. Simple 10A, 5V-to-3.3V Voltage Regulator

A momentary short can increase power dissipation in a MOSFET voltage regulator pass device to a

catastrophic level. In the circuit of Figure 4-13, normal Q1 power dissipation is $I_{OUT} \times V_{DS}$, or

$$(5 - 3.3)V \times 10A = 17W.$$

Given the $0.028\Omega R_{DS(ON)}$ of the IRLZ44, if the output of the power supply is shorted, power dissipation becomes $(V_{IN}/R_{DS(ON)})^2 \times R_{DS(ON)}$, or an unworkable 892W. Conservative heat sink design will not help matters!

The Micrel MIC5156/5157/5158 Super LDO™ Regulator Controllers offer two features that can be used to save the pass device. The first feature is a current limit capability (not implemented in Figure 4-13). Output current can be limited at a user-defined value, but the function is not the classic foldback scheme. While fixed-value current limiting can reduce shorted-output power dissipation to a manageable level, the additional dissipation imposed by the short can still threaten the pass device. Power dissipation of a current-limited supply is the full supply voltage multiplied by the current limit of the regulator system: $5V \times (>) 10A > 50W$. At higher input supply voltages and/or higher current limit levels, power dissipation rises rapidly—a 30V supply limited to 10A has a short-circuit dissipation of 300W. When considerable voltage is being dropped by the pass device the short-circuit power dissipation becomes dramatically high.

The second feature offered by the MIC5156/5157/5158 is an error flag. This is an open-collector output which generates a signal if the output voltage is approximately 6% or more below the intended value. This flag output is asserted logic low in the event of a shorted output, and may be used to control the enable-input pin of the regulator, disabling it upon detection of a low output voltage condition.

An Example

Figure 4-14 implements both the current-limit capability and a control scheme for dealing with shorted outputs. The $2.3m\Omega$ resistor R_S provides for current limiting at about 15A. Since a shorted output may be momentary, the circuitry built around U1 automatically restarts the regulator when a short is removed. Existence of a shorted output is continually monitored; the system will protect the pass device for an indefinite time. When a short exists the regulator is enabled for a very brief interval and disabled for a much longer interval. Power dissipation is reduced by this drop in duty cycle, which may be empirically designed.

Circuit Description

Schmitt-trigger NAND-gate A is used to control a gated oscillator (gate B). Resistors R5 and R6, diode D3, and capacitor C5 provide oscillator timing. With the values shown the enable time is about 110ms approximately every 2.25ms. This provides a safe 1:20 ON/OFF ratio (5% duty cycle) for reducing power dissipated by the pass device. Diode D2 keeps C5 discharged until gate A enables the oscillator. This assures that oscillation will begin with a full-width short enable pulse. Different enable and/or disable times may be appropriate for some applications. Enable time is approximately $k1 \times R5 \times C5$; disable time is approximately $k2 \times R6 \times C5$. Constants $k1$ and $k2$ are determined primarily by the two threshold voltages (V_{T+} and V_{T-}) of Schmitt-trigger gate B. Values for $k1$ and $k2$ (empirically derived from a breadboard) are 0.33 and 0.23, respectively. Component tolerances were ignored.

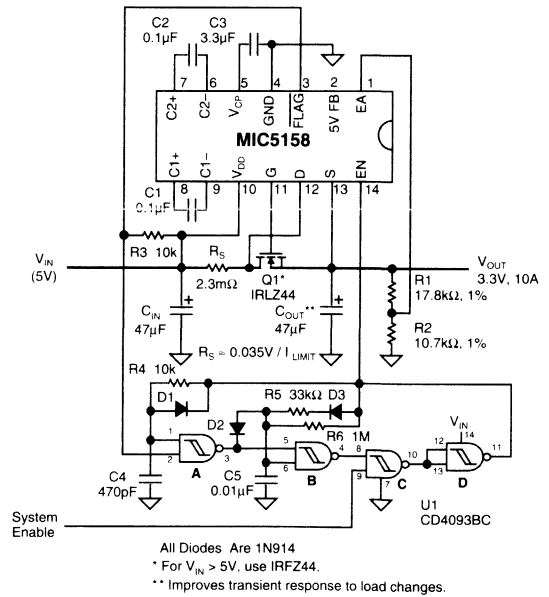

Figure 4-14. Short-Circuit Protected 10A Regulator

Getting Started

The protection circuitry provides a system enable input. Use of this input is optional; it should be tied to V_{IN} if not required. Since the output of gate B is logic high when the oscillator is disabled, a logic-high system enable input enables the MIC5158, which immediately produces a brief logic-low flag output because initially, the output voltage is too low. Since

the power supply output may or may not be shorted it is desirable to wait and see. The required wait-delay timing is implemented by resistor R4, capacitor C4, and diode D1. The leading-edge of the regulator enable signal is delayed (before application to gate A) for about 4ms, to attempt to span the width of the logic-low flag that is generated during a normal (non-short) regulator start-up.

Providing enough delay time to span the time of the flag may not always be practical, especially when starting with high-capacitance loads. If the logic-low flag is longer than the delayed enable input to gate A, the oscillator will cycle through its ON/OFF duty cycle and the circuit will again attempt a normal start-up. This will result in a slowing of the regulator turn-on, but this is not usually objectionable because it reduces turn-on surge currents.

After start-up, the logic-high inputs to gate A hold the oscillator off, and the system remains enabled as long as no error flag is generated. If the flag is generated due to a short, the MIC5158 remains enabled only for the time of the oscillator enable pulse and is then immediately disabled for the duration of the oscillator cycle. As long as the short exists, the oscillator runs and the system monitors the flag to detect removal of the short. Meanwhile the MOSFET stays alive, and the system again starts when the short is removed.

Section 5. Micrel Low-Dropout Regulator Data Sheets

Monolithic Regulators

MIC5230 10mA Micropower Low-Dropout Linear Regulator	76
MIC5203 80mA Low-Dropout Voltage Regulator	81
MIC5200 100mA Low-Dropout Voltage Regulator	87
MIC5202 Dual 100mA Low-Dropout Voltage Regulator	93
LP2950/2951 100mA Low-Dropout Voltage Regulator (Summary Info.)	99
MIC2950/2951 150mA Low-Dropout Voltage Regulator	100
MIC5205 150mA Low Noise Low-Dropout Voltage Regulator	115
MIC5206 150mA Low Noise Low-Dropout Voltage Regulator	122
MIC5207 180mA Low Noise Low-Dropout Voltage Regulator	129
MIC5201 200mA Low-Dropout Voltage Regulator	136
MIC2954 250mA Low-Dropout Voltage Regulator	142
MIC2920A/29201/29202/29203/29204 400mA LDO Regulator	152
MIC2937A/29371/29372/29373 750mA Low-Dropout Voltage Regulator	161
MIC2940A/2941A 1.25A Low-Dropout Voltage Regulator	170
MIC29150/29151/29152/29153 1.5A Low-Dropout Voltage Regulator	178
MIC29300/29301/29302/29303 3A Low-Dropout Voltage Regulator	178
MIC29310/29312 3A Low-Dropout Voltage Regulator	193
MIC29500/501/502/503 5A Low-Dropout Voltage Regulator	178
MIC29510/29512 5A Low-Dropout Voltage Regulator	201
MIC29710/29712 7.5A Low-Dropout Voltage Regulator	209
MIC29750/29751/29752 7.5A Low-Dropout Voltage Regulator	178
MIC5156/5157/5158 "Super LDO"	217
Switching Regulator Selector Guide	228

General Description

The MIC5230 is a family of efficient linear voltage regulators with a very low dropout voltage (typically 20mV at light loads and 132mV at 10mA), and an extremely low ground current (1 μ A typical, across the full output current range).

Designed especially for hand-held battery powered devices, the MIC5230 offers better than 3% initial accuracy. This regulator's ability to also sink current improves regulation under very light-load conditions.

The MIC5230 is offered in the tiny SOT-23-5 package with a 5.0V fixed output voltage. Other voltages are available. Contact Micrel for details.

Features

- Extremely low quiescent current
- Tiny SOT-23-5 surface mount package
- Wide selection of output voltages
- Guaranteed 10mA output
- Low dropout voltage
- No output capacitor needed
- Insensitive to output capacitor ESR
- Tight load and line regulation
- Low temperature coefficient

Applications

- Real time clocks
- SRAM backup
- Cellular telephones
- Laptop, notebook, and palmtop computers
- Battery-powered equipment
- Bar code scanners
- SMPS post-regulator/dc-to-dc modules
- High-efficiency linear power supplies

Ordering Information

Part Number	Marking	Voltage	Temperature Range	Package
MIC5230-5.0BM5	LC50	5.0V	-40°C to +85°C	SOT-23-5

Other voltages available. Contact Micrel for details.

Typical Application

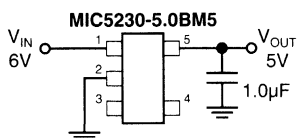

5V Linear Regulator Application

Pin Configuration

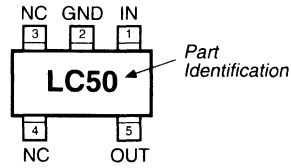

MIC5230-5.0BM5

Pin Description

Pin Number	Pin Name	Pin Function
1	IN	Supply Input
2	GND	Ground
3,4	NC	Not internally connected. Connect to ground plane for lowest package thermal resistance.
5	OUT	Regulated Output

Absolute Maximum Ratings (Note 1)

Supply Voltage (V_{IN})	-0.6V to +18V
Output Current (I_{OUT})	0.5A peak
Power Dissipation (P_D)	0.3W @ 25°C
Lead Temperature (soldering, 5 sec.)	260°C
Storage Temperature (T_A)	-60°C to +150°C

Operating Ratings

Input Voltage (V_{IN})	3.5V to 16V
Output Current (I_{OUT})	40mA
Ambient Temperature (T_A)	-40°C to +85°C
Junction Temperature (T_J)	-40°C to +125°C
Thermal Resistance	Note 6

Electrical Characteristics

$V_{IN} = V_{OUT} + 1V$; $I_L = 1mA$; $C_L = 1\mu F$; $T_J = 25^\circ C$, **bold** values indicate $-40^\circ C \leq T_J \leq +125^\circ C$; unless noted.

Symbol	Parameter	Conditions	Min	Typ	Max	Units
V_{OUT}	Output Voltage	initial variation from nominal V_{OUT}	-3		3	%
$\Delta V_{OUT}/\Delta T$	Output Voltage Temperature Coefficient	Note 2		800	1200	ppm/ $^\circ C$
$\Delta V_{OUT}/V_{OUT}$	Line Regulation	$V_{IN} = 6V$ to $16V$		0.2	0.25	%
$\Delta V_{OUT}/V_{OUT}$	Load Regulation	$I_L = 10\mu A$ to $10mA$, Note 3		0.12		%
		$I_L = 10\mu A$ sink to $10\mu A$ source, Note 4		2.4		%
V_{DO}	Dropout Voltage, Note 5	$I_L = 1mA$		13		mV
		$I_L = 10mA$		132		mV
I_Q	Ground Pin Current	$V_{IN} = 6V$, $I_L = 10mA$		1	3	μA
		$V_{IN} = 16V$, $I_L = 10mA$		1.1	4	μA
I_{SC}	Short Circuit Current, Note 1	$V_{OUT} = 0V$, $V_{DD} = 6V$		200	300	mA

General Note: Devices are ESD protected; however, handling precautions are recommended.

Note 1: Absolute maximum ratings indicate limits beyond which damage to the component may occur. Electrical specifications do not apply when operating the device outside of its rated operating conditions.

Note 2: Output voltage temperature coefficient is defined as the worst case voltage change divided by the total temperature range.

Note 3: Regulation is measured at constant junction temperature using low duty cycle pulse testing.

Note 4: Load regulation (sink to source) is the difference in output voltage when a $10\mu A$ current reverses from sinking to sourcing. The MIC5230 will sink as well as source output current.

Note 5: Dropout voltage is defined as the input to output differential at which the output voltage drops 2% below its nominal value measured at 1V differential.

Note 6: The maximum allowable power dissipation is a function of the maximum junction temperature, $T_{J(max)}$, the junction-to-ambient thermal resistance, θ_{JA} , and the ambient temperature, T_A . The maximum allowable power dissipation at any ambient temperature is calculated using: $P_{D(max)} = (T_{J(max)} - T_A) / \theta_{JA}$. The θ_{JC} of the MIC5230 is $180^\circ C/W$. Mounted to a standard PC board, the θ_{JA} is approximately $220^\circ C/W$.

Typical Characteristics

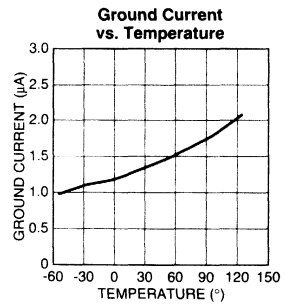
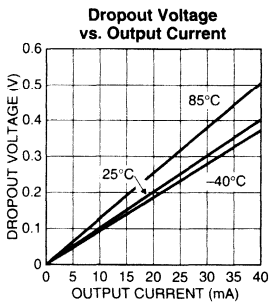
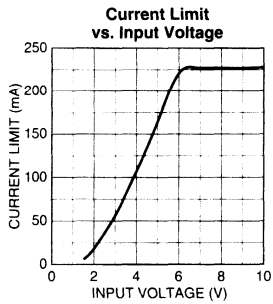
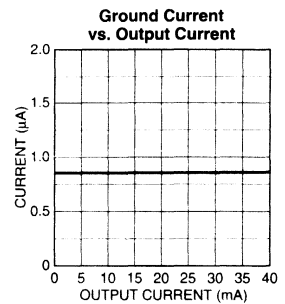
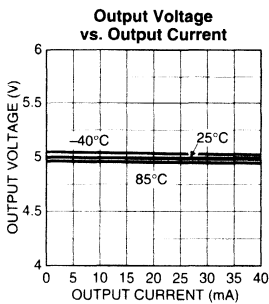
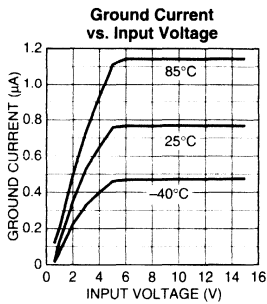
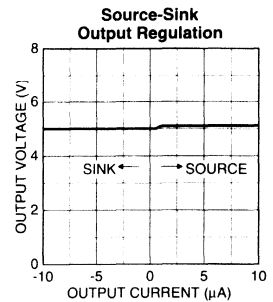
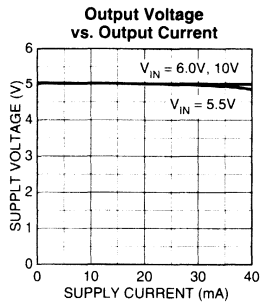
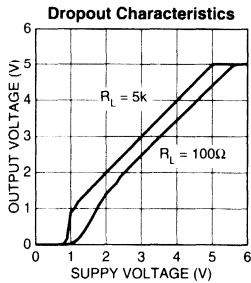

Applications Information

Input Capacitor

A 0.1 μ F (or larger) capacitor should be placed from the IN (supply input) to GND (ground) if there is more than 20 cm of wire between IN and the ac filter capacitor or if supplied from a battery.

Output Capacitors

The MIC5230 does not require an output capacitor for stability. A 1 μ F or larger capacitor is recommended between OUT (output) and GND to improve the regulator's transient response. 0.1 μ F can be used to reduce overshoot recovery time at the expense of overshoot amplitude. The ESR (effective series resistance) of this capacitor has no effect on regulator stability, but low-ESR capacitors improve high frequency transient response. The value of this capacitor may be increased without limit, but values larger than 10 μ F tend to increase the settling time after a step change in input voltage or output current.

The MIC5230 has no minimum load current; it will remain stable and in regulation with no load (other than the internal voltage divider). This is especially important in real-time clock and CMOS RAM keep-alive applications.

Safe Operating Conditions

MIC5230 output current is not internally limited. Under short-circuit conditions, output current is proportional to input voltage and the resulting power dissipation may cause excessive junction temperatures. The typical short circuit current with an input voltage of 6V is 200mA, or a power dissipation of 1.2W. Since overtemperature shutdown is not provided, power dissipation must be limited to prevent the junction temperature from exceeding +125°C.

Microcurrent Converter

The MIC5230 can be used to regulate the output of an MIC2660 charge pump to create a 3V to 5V converter. See Figure 1. This converter is suitable for where 5V at 5mA or less is needed within a circuit otherwise powered from a 3V supply.

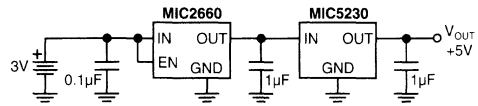

Figure 1. 3V to 5V/5mA Converter

General Description

The MIC5203 is a family of efficient linear voltage regulators with very low dropout voltage (typically 20mV at light loads and 300mV at 80mA), and very low ground current (225µA at 10mA output), offering better than 3% initial accuracy with a logic compatible ON/OFF switching input. Designed especially for hand-held battery powered devices, the MIC5203 is switched by a CMOS or TTL compatible logic signal and when disabled, power consumption drops nearly to zero. If logic control is not required, the Enable pin may be tied to the Input for 3-terminal operation. The ground current of the MIC5203 increases only slightly in dropout, further prolonging battery life. Key MIC5203 features include protection against reversed battery, current limiting, and overtemperature shutdown.

The MIC5203 is available in 3.0V, 3.3V, 3.6V, 3.8V, 4.0V, 4.75V, and 5.0V fixed voltage configurations. Other voltages are available; contact Micrel for details.

Features

- Tiny four lead surface mount package
- Wide Selection of output voltages
- Guaranteed 80mA output
- Low quiescent current
- Low dropout voltage
- Tight load and line regulation
- Low temperature coefficient
- Current and thermal limiting
- Reversed input polarity protection
- Zero OFF mode current
- Logic-controlled electronic shutdown

Applications

- Cellular Telephones
- Laptop, Notebook, and Palmtop Computers
- Battery Powered Equipment
- Bar Code Scanners
- SMPS Post-Regulator/ DC to DC Modules
- High Efficiency Linear Power Supplies

Ordering Information

Part Number	Marking	Volts	Junction Temperature Range	Package
MIC5203-3.0BM4	LA30	3.0	-40°C to +125°C	SOT-143
MIC5203-3.3BM4	LA33	3.3	-40°C to +125°C	SOT-143
MIC5203-3.6BM4	LA36	3.6	-40°C to +125°C	SOT-143
MIC5203-3.8BM4	LA38	3.8	-40°C to +125°C	SOT-143
MIC5203-4.0BM4	LA40	4.0	-40°C to +125°C	SOT-143
MIC5203-4.7BM4	LA47	4.75	-40°C to +125°C	SOT-143
MIC5203-5.0BM4	LA50	5.0	-40°C to +125°C	SOT-143

Other voltages are available; contact Micrel for details.

The -40°C to +125°C rated MIC5203-xxBM4 replaces the 0°C to +125°C MIC5203CM4.

Typical Application

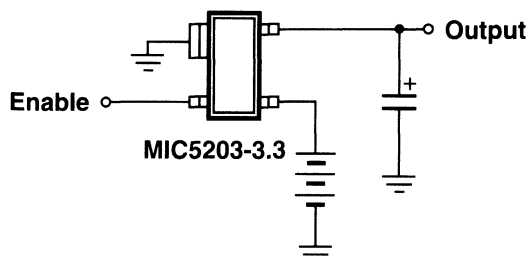

Pin Configuration

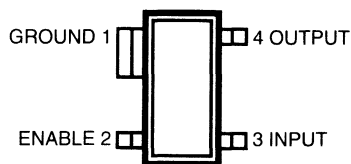

Absolute Maximum Ratings

Absolute Maximum Ratings indicate limits beyond which damage to the device may occur. Electrical specifications do not apply when operating the device beyond its specified **Recommended Operating Conditions**.

Power Dissipation	Internally Limited
Lead Temperature (Soldering, 5 seconds)	260°C
Storage Temperature Range	-60°C to +150°C
Input Supply Voltage	-20V to +20V
ENABLE Input Voltage	-20V to +20V

Recommended Operating Conditions

Input Voltage	2.5V to 16V
Operating Junction Temperature Range	-40°C to +125°C
ENABLE Input Voltage	0V to V_{CC}
SOT-143 θ_{JA}	See Note 1

Electrical Characteristics

Limits in standard typeface are for $T_j = 25^\circ\text{C}$ and limits in **boldface** apply over the junction temperature range of -40°C to $+125^\circ\text{C}$. Unless otherwise specified, $V_{IN} = V_{OUT} + 1\text{V}$, $I_L = 1\text{mA}$, $C_L = 1\mu\text{F}$, and $V_{CONTROL} \geq 2.0\text{V}$.

Symbol	Parameter	Conditions	Min	Typical	Max	Units
V_O	Output Voltage Accuracy		-3 -4		3 4	%
$\frac{\Delta V_O}{\Delta T}$	Output Voltage Temperature Coef.	(Note 2)		50	200	ppm/°C
$\frac{\Delta V_O}{V_O}$	Line Regulation	$V_{IN} = V_{OUT} + 1\text{V}$ to 16V		0.008	0.3 0.5	%
$\frac{\Delta V_O}{V_O}$	Load Regulation	$I_L = 0.1\text{mA}$ to 80mA (Note 3)		0.08	0.3 0.5	%
$V_{IN} - V_O$	Dropout Voltage (Note 4)	$I_L = 100\mu\text{A}$ $I_L = 20\text{mA}$ $I_L = 50\text{mA}$ $I_L = 80\text{mA}$		20 200 250 300	350 600	mV
I_O	Quiescent Current	$V_{CONTROL} \leq 0.4\text{V}$ (Shutdown)		0.01	10	μA
I_{GND}	Ground Pin Current (Note 5)	$V_{CONTROL} \geq 2.0\text{V}$ (Active), $I_L = 100\mu\text{A}$ $I_L = 20\text{mA}$ $I_L = 50\text{mA}$ $I_L = 80\text{mA}$		180 225 850 1800	750 3000	μA
I_{GNDDO}	Ground Pin Current at Dropout	$V_{IN} = 0.5\text{V}$ less than designed V_{OUT} (Note 5)		200	300	μA
I_{LIMIT}	Current Limit	$V_{OUT} = 0\text{V}$		180	250	mA
$\frac{\Delta V_O}{\Delta P_D}$	Thermal Regulation	(Note 6)		0.05		%/W

Control Input

V_{IL} V_{IH}	Input Voltage Level Logic Low Logic High	OFF ON	2.0		0.6	V
I_{IL} I_{IH}	Control Input Current	$V_{IL} \leq 0.6\text{V}$ $V_{IH} \geq 2.0\text{V}$		0.01 15	1 50	μA

Notes:

General Note: Devices are ESD protected, however, handling precautions are recommended.

Note 1: Absolute maximum ratings indicate limits beyond which damage to the component may occur. Electrical specifications do not apply when operating the device outside of its rated operating conditions. The maximum allowable power dissipation is a function of the maximum junction temperature, $T_{J\text{MAX}}$, the junction-to-ambient thermal resistance, θ_{JA} , and the ambient temperature, T_A . The maximum allowable power dissipation at any ambient temperature is calculated using: $P_{\text{MAX}} = (T_{J\text{MAX}} - T_A) / \theta_{JA}$. Exceeding the maximum allowable power dissipation will result in excessive die temperature, and the regulator will go into thermal shutdown. θ_{JA} of the SOT-143 is 250°C/W, mounted on a PC board.

Note 2: Output voltage temperature coefficient is defined as the worst case voltage change divided by the total temperature range.

Note 3: Regulation is measured at constant junction temperature using low duty cycle pulse testing. Changes in output voltage due to heating effects are covered by the thermal regulation specification.

Note 4: Dropout voltage is defined as the input to output differential at which the output voltage drops 2% below its nominal value measured at 1V differential.

Note 5: Ground pin current is the regulator quiescent current plus pass transistor base current. The total current drawn from the supply is the sum of the load current plus the ground pin current.

Note 6: Thermal regulation is defined as the change in output voltage at a time "t" after a change in power dissipation is applied, excluding load or line regulation effects. Specifications are for a 80mA load pulse at $V_{IN} = 16V$ for $t = 10ms$.

Typical Characteristics

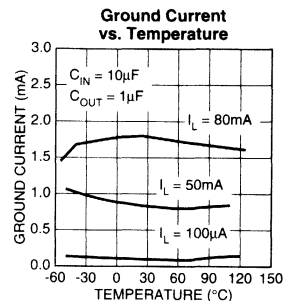
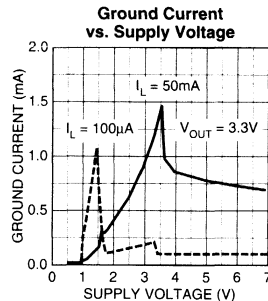
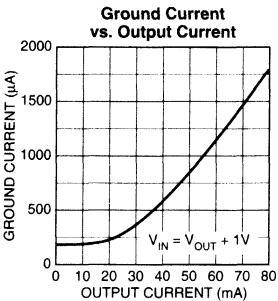
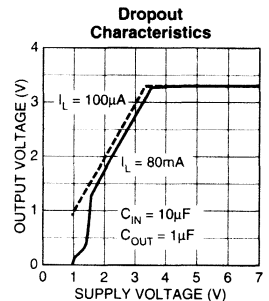
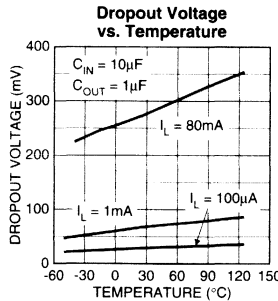
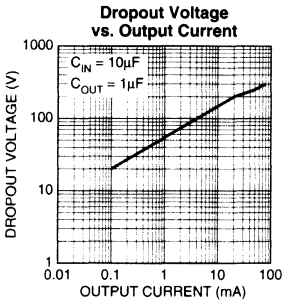

Typical Characteristics

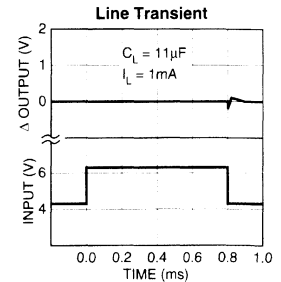
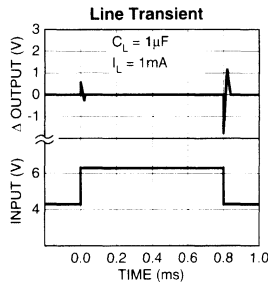
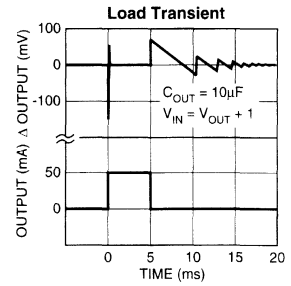
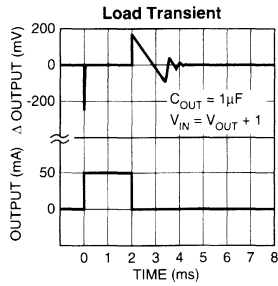
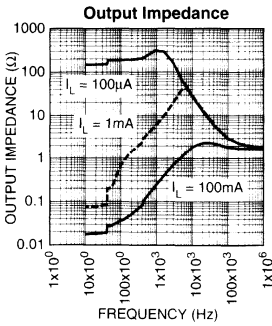
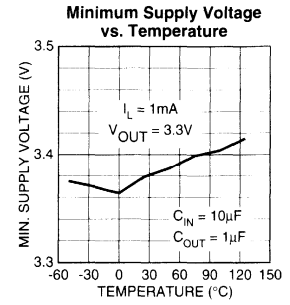
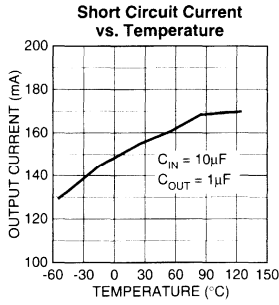
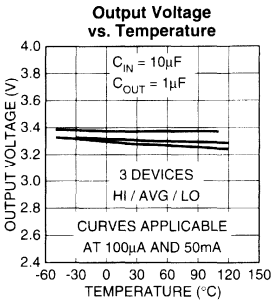
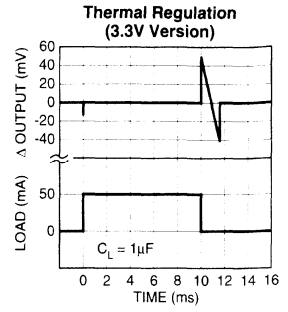
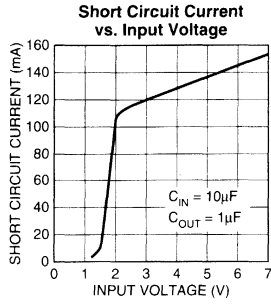
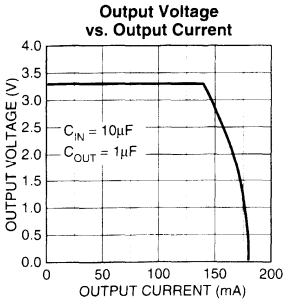

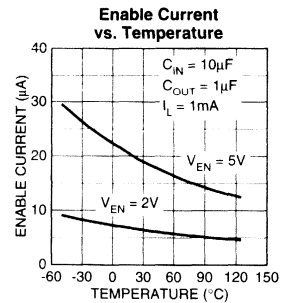
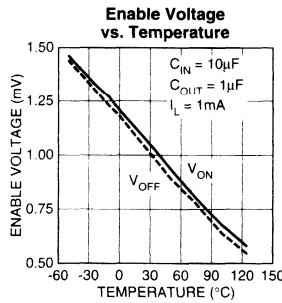
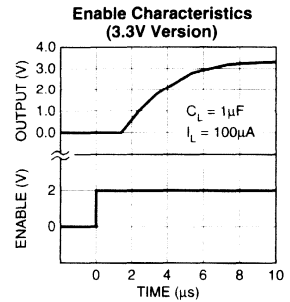
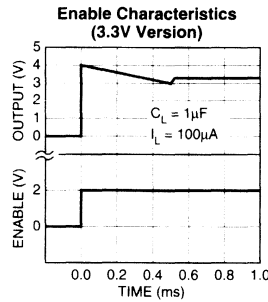
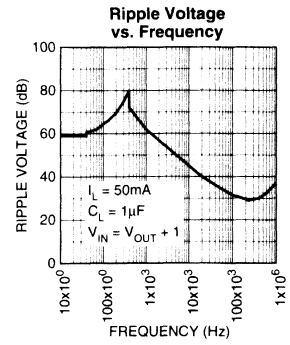
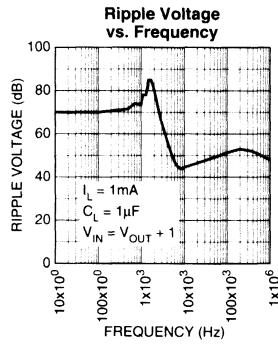
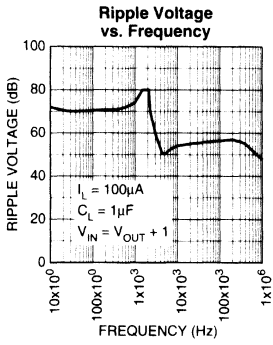

Applications Information

External Capacitors

A 1 μ F capacitor is recommended between the MIC5203 output and ground to prevent oscillations due to instability. Larger values serve to improve the regulator's transient response. Most types of tantalum or aluminum electrolytics will be adequate; film types will work, but are costly and therefore not recommended. Many aluminum electrolytics have electrolytes that freeze at about -30°C , so solid tantalums are recommended for operation below -25°C . The important parameters of the capacitor are an effective series resistance of about 5Ω or less and a self-resonant frequency above 500kHz. The value of this capacitor may be increased without limit.

At lower values of output current, less output capacitance is required for output stability. The capacitor can be reduced to 0.22 μ F for current below 10mA or 0.1 μ F for currents below 1 mA.

The MIC5203 will remain stable and in regulation with no load other than the internal voltage divider, unlike many other voltage regulators. This is especially important in CMOS RAM keep-alive applications.

A 0.1 μ F (or larger) capacitor should be placed from the MIC5203 input to ground if there is more than 10 inches of wire between the input and the AC filter capacitor or if a battery is used as the input.

ENABLE Input

The MIC5203 features nearly zero OFF mode current. When the ENABLE input is held below 0.6V, all internal circuitry is powered off. Pulling this pin high (over 2.0V) re-enables the device and allows operation. The ENABLE pin requires a small amount of current, typically 15 μ A. While the logic threshold is TTL/CMOS compatible, ENABLE may be pulled as high as 20V, independent of the voltage on V_{IN} .

General Description

The MIC5200 is an efficient linear voltage regulator with very low dropout voltage (typically 17mV at light loads and 200mV at 100mA), and very low ground current (1mA at 100mA output), offering better than 1% initial accuracy with a logic compatible ON/OFF switching input. Designed especially for hand-held battery powered devices, the MIC5200 is switched by a CMOS or TTL compatible logic signal. The ENABLE control may be tied directly to V_{IN} if unneeded. When disabled, power consumption drops nearly to zero. The ground current of the MIC5200 increases only slightly in dropout, further prolonging battery life. Key MIC5200 features include protection against reversed battery, current limiting, and over-temperature shutdown.

The MIC5200 is available in several fixed voltages and accuracy configurations. Other options are available; contact Micrel for details.

Features

- High output voltage accuracy
- Variety of output voltages
- Guaranteed 100mA output
- Low quiescent current
- Low dropout voltage
- Extremely tight load and line regulation
- Very low temperature coefficient
- Current and thermal limiting
- Zero OFF mode current
- Logic-controlled electronic shutdown
- Available in SO-8 and SOT-223 packages

Applications

- Cellular Telephones
- Laptop, Notebook, and Palmtop Computers
- Battery Powered Equipment
- PCMCIA V_{CC} and V_{PP} Regulation/Switching
- Bar Code Scanners
- SMPS Post-Regulator/ DC to DC Modules
- High Efficiency Linear Power Supplies

Ordering Information

Part Number	Volts	Accuracy	Temperature Range*	Package
MIC5200-3.0BM	3.0	1%	-40°C to +125°C	SO-8
MIC5200-3.3BM	3.3	1%	-40°C to +125°C	SO-8
MIC5200-4.8BM	4.85	1%	-40°C to +125°C	SO-8
MIC5200-5.0BM	5.0	1%	-40°C to +125°C	SO-8
MIC5200-3.0BS	3.0	1%	-40°C to +125°C	SOT-223
MIC5200-3.3BS	3.3	1%	-40°C to +125°C	SOT-223
MIC5200-4.8BS	4.85	1%	-40°C to +125°C	SOT-223
MIC5200-5.0BS	5.0	1%	-40°C to +125°C	SOT-223

* Junction Temperature

Other voltages are available; contact Micrel for details.

Typical Application

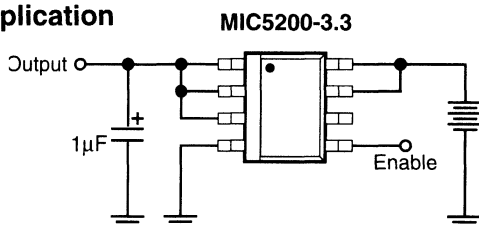

Pin Configuration

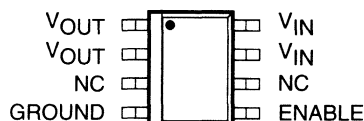

MIC5200-xxBM

Both V_{IN} and both V_{OUT} pins must be tied together. ENABLE must be pulled high for operation.

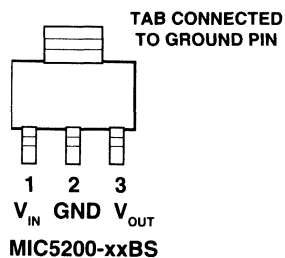

MIC5200-xxBS

ENABLE may be tied directly to V_{IN}

Absolute Maximum Ratings

Absolute Maximum Ratings indicate limits beyond which damage to the device may occur. Electrical specifications do not apply when operating the device beyond its specified **Operating Ratings**.

Power Dissipation	Internally Limited
Lead Temperature (Soldering, 5 seconds)	260°C
Operating Junction Temperature Range	-40°C to +125°C
Input Supply Voltage	-20V to +60V
ENABLE Input Voltage	-20V to +60V
ESD Rating	> 2000V

Thermal Characteristics

SOT-223 (θ_{JC})	15°C/W
SO-8 (θ_{JA})	See Note 1

Recommended Operating Conditions

Input Voltage	2.5V to 26V
Operating Junction Temperature Range	-40°C to +125°C
ENABLE Input Voltage	-20V to V_{IN}

Electrical Characteristics

Limits in standard typeface are for $T_J = 25^\circ\text{C}$ and limits in **boldface** apply over the junction temperature range of -40°C to $+125^\circ\text{C}$. Unless otherwise specified, $V_{IN} = V_{OUT} + 1\text{V}$, $I_L = 1\text{mA}$, $C_L = 3.3\mu\text{F}$, and $V_{ENABLE} \geq 2.0\text{V}$

Symbol	Parameter	Conditions	Min	Typical	Max	Units
V_O	Output Voltage Accuracy	Variation from specified V_{OUT}	-1 -2		1 2	%
$\frac{\Delta V_O}{\Delta T}$	Output Voltage Temperature Coef.	(Note 2)		40	150	ppm/°C
$\frac{\Delta V_O}{V_{IN}}$	Line Regulation	$V_{IN} = V_{OUT} + 1\text{V}$ to 26V		0.004	0.10 0.40	%
$\frac{\Delta V_O}{V_{OUT}}$	Load Regulation	$I_L = 0.1\text{mA}$ to 100mA (Note 3)		0.04	0.16 0.30	%
$V_{IN} - V_O$	Dropout Voltage (Note 4)	$I_L = 100\mu\text{A}$ $I_L = 20\text{mA}$ $I_L = 30\text{mA}$ $I_L = 50\text{mA}$ $I_L = 100\text{mA}$		17 130 150 190 230	350	mV
I_{GND}	Quiescent Current	$V_{ENABLE} \leq 0.7\text{V}$ (Shutdown)		0.01	10	μA
I_{GND}	Ground Pin Current	$V_{ENABLE} \geq 2.0\text{V}$, $I_L = 100\mu\text{A}$ $I_L = 20\text{mA}$ $I_L = 30\text{mA}$ $I_L = 50\text{mA}$ $I_L = 100\text{mA}$		130 270 330 500 1000	350 1500	μA
PSRR	Ripple Rejection			70		dB
I_{GNDDO}	Ground Pin Current at Dropout	$V_{IN} = 0.5\text{V}$ less than specified V_{OUT} $I_L = 100\mu\text{A}$ (Note 5)		270	330	μA
I_{LIMIT}	Current Limit	$V_{OUT} = 0\text{V}$	100	250		mA
$\frac{\Delta V_O}{\Delta P_D}$	Thermal Regulation	(Note 6)		0.05		%/W
e_n	Output Noise			100		μV

ENABLE Input

V_{IL}	Input Voltage Level Logic Low Logic High	OFF ON	2.0		0.7	V
I_{IL} I_{IH}	ENABLE Input Current	$V_{IL} \leq 0.7\text{V}$ $V_{IH} \geq 2.0\text{V}$		0.01 15	1 50	μA

- Note 1:** Absolute maximum ratings indicate limits beyond which damage to the component may occur. Electrical specifications do not apply when operating the device outside of its rated operating conditions. The maximum allowable power dissipation is a function of the maximum junction temperature, $T_{J(MAX)}$, the junction-to-ambient thermal resistance, θ_{JA} , and the ambient temperature, T_A . The maximum allowable power dissipation is calculated using: $P_{(MAX)} = (T_{J(MAX)} - T_A) \div \theta_{JA}$. Exceeding the maximum allowable power dissipation will result in excessive die temperature, and the regulator will go into thermal shutdown. The θ_{JC} of the MIC5200-xxBS is 15°C/W and θ_{JA} for the MIC5200BM is 160°C/W mounted on a PC board (see "Thermal Considerations" section for further details).
- Note 2:** Output voltage temperature coefficient is defined as the worst case voltage change divided by the total temperature range.
- Note 3:** Regulation is measured at constant junction temperature using low duty cycle pulse testing. Parts are tested for load regulation in the load range from 0.1mA to 100mA. Changes in output voltage due to heating effects are covered by the thermal regulation specification.
- Note 4:** Dropout Voltage is defined as the input to output differential at which the output voltage drops 2% below its nominal value measured at 1V differential.
- Note 5:** Ground pin current is the regulator quiescent current plus pass transistor base current. The total current drawn from the supply is the sum of the load current plus the ground pin current.
- Note 6:** Thermal regulation is defined as the change in output voltage at a time T after a change in power dissipation is applied, excluding load or line regulation effects. Specifications are for a 100mA load pulse at $V_{IN} = 26V$ for $T = 10ms$.

Typical Characteristics

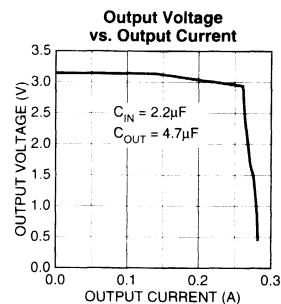
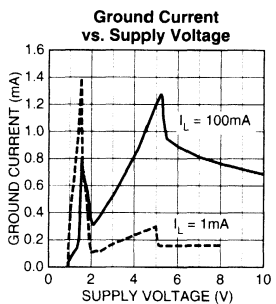
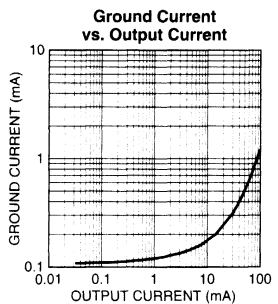
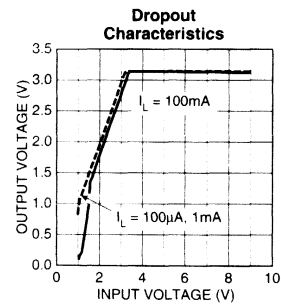
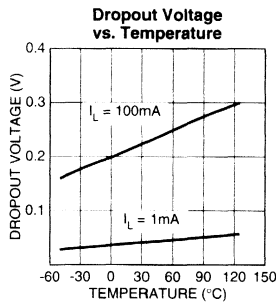
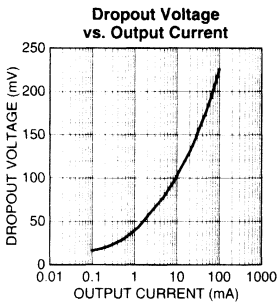

Typical Characteristics

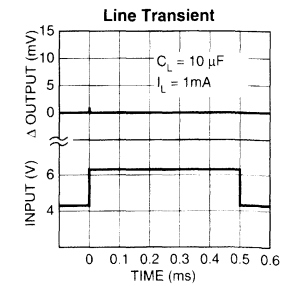
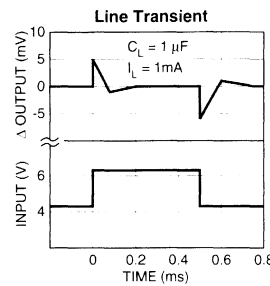
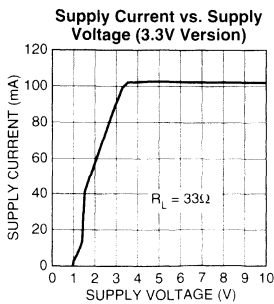
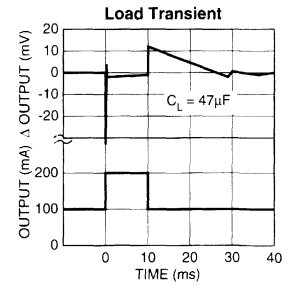
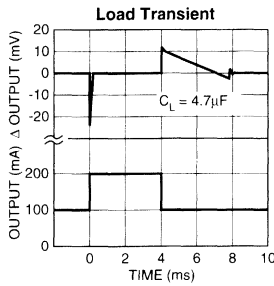
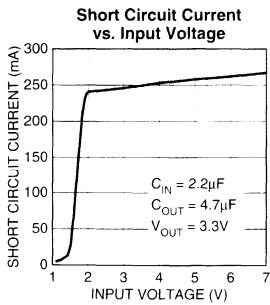
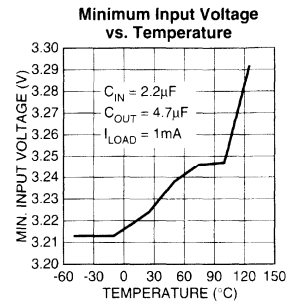
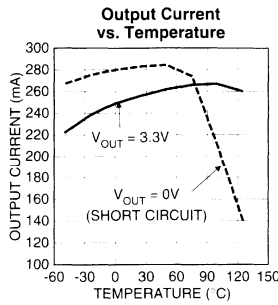
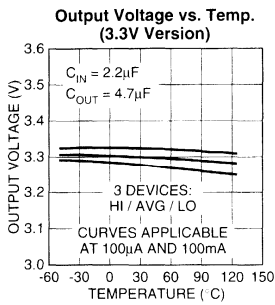
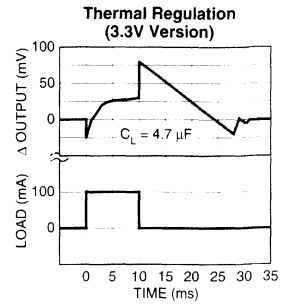
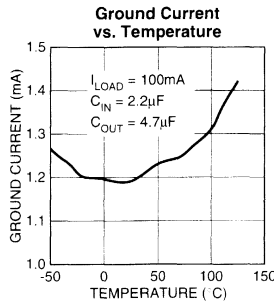
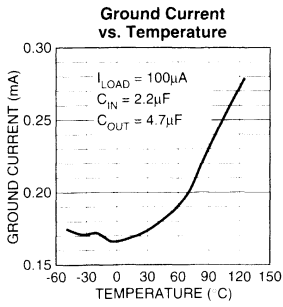

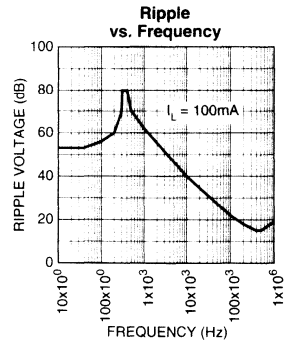
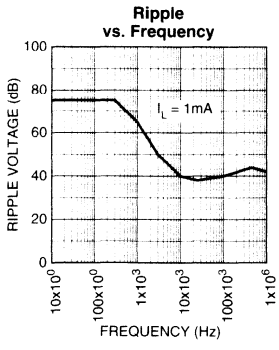
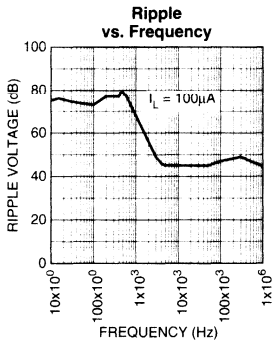
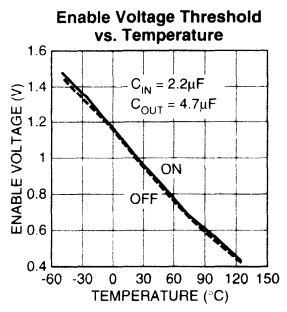
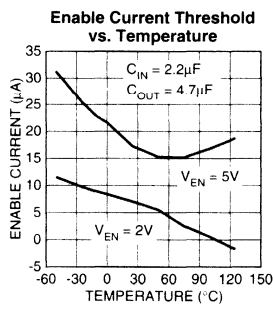
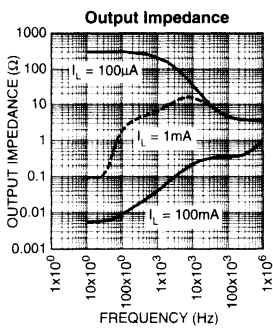
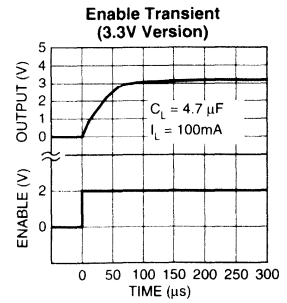
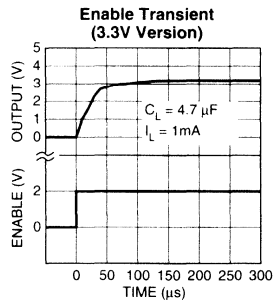
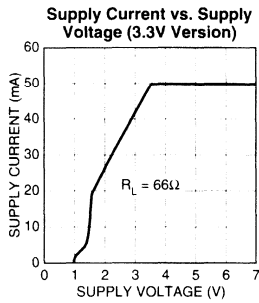

Applications Information

External Capacitors

A 1 μ F capacitor is recommended between the MIC5200 output and ground to prevent oscillations due to instability. Larger values serve to improve the regulator's transient response. Most types of tantalum or aluminum electrolytics will be adequate; film types will work, but are costly and therefore not recommended. Many aluminum electrolytics have electrolytes that freeze at about -30°C , so solid tantalum capacitors are recommended for operation below -25°C . The important parameters of the capacitor are an effective series resistance of about 5Ω or less and a resonant frequency above 500kHz. The value of this capacitor may be increased without limit.

At lower values of output current, less output capacitance is required for output stability. The capacitor can be reduced to 0.47 μ F for current below 10mA or 0.33 μ F for currents below 1 mA. A 1 μ F capacitor should be placed from the MIC5200 input to ground if there is more than 10 inches of wire between the input and the AC filter capacitor or if a battery is used as the input.

The MIC5200 will remain stable and in regulation with no load in addition to the internal voltage divider, unlike many other voltage regulators. This is especially important in CMOS RAM keep-alive applications.

When used in dual supply systems where the regulator load is returned to a negative supply, the output voltage must be diode clamped to ground.

ENABLE Input

The MIC5200 features nearly zero OFF mode current. When the ENABLE input is held below 0.7V, all internal circuitry is powered off. Pulling this pin high (over 2.0V) re-enables the device and allows operation. The ENABLE pin requires a small amount of current, typically 15 μ A. While the logic threshold is TTL/CMOS compatible, ENABLE may be pulled as high as 30V, independent of the voltage on V_{IN} .

Thermal Considerations

Part I. Layout

The MIC5200-xxBM (8-pin surface mount package) has the following thermal characteristics when mounted on a single layer copper-clad printed circuit board.

PC Board Dielectric	θ_{JA}
FR4	160 $^{\circ}\text{C}/\text{W}$
Ceramic	120 $^{\circ}\text{C}/\text{W}$

Multi-layer boards having a ground plane, wide traces near the pads, and large supply bus lines provide better thermal conductivity.

The "worst case" value of 160 $^{\circ}\text{C}/\text{W}$ assumes no ground plane, minimum trace widths, and a FR4 material board.

Part II. Nominal Power Dissipation and Die Temperature

The MIC5200-xxBM at a 25 $^{\circ}\text{C}$ ambient temperature will operate reliably at up to 625mW power dissipation when mounted in the "worst case" manner described above. At an ambient temperature of 55 $^{\circ}\text{C}$, the device may safely dissipate 440mW. These power levels are equivalent to a die temperature of 125 $^{\circ}\text{C}$, the recommended maximum temperature for non-military grade silicon integrated circuits.

For MIC5200-xxBS (SOT-223 package) heat sink characteristics, please refer to Micrel Application Hint 17, "Calculating P.C. Board Heat Sink Area for Surface Mount Packages".

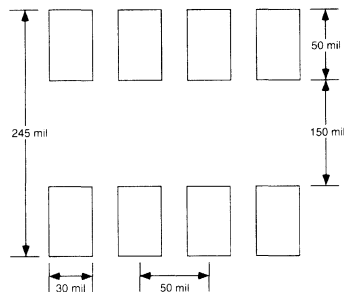

Minimum recommended board pad size, SO-8.

General Description

The MIC5202 is a family of dual linear voltage regulators with very low dropout voltage (typically 17mV at light loads and 210mV at 100mA), and very low ground current (1mA at 100mA output—each section), offering better than 1% initial accuracy with a logic compatible ON/OFF switching input. Designed especially for hand-held battery powered devices, the MIC5202 is switched by a CMOS or TTL compatible logic signal. This ENABLE control may be tied directly to V_{IN} if unneeded. When disabled, power consumption drops nearly to zero. The ground current of the MIC5202 increases only slightly in dropout, further prolonging battery life. Key MIC5202 features include protection against reversed battery, current limiting, and over-temperature shutdown.

The MIC5202 is available in several fixed voltages. Other options are available; contact Micrel for details.

Features

- High output voltage accuracy
- Variety of output voltages
- Guaranteed 100mA output
- Low quiescent current
- Low dropout voltage
- Extremely tight load and line regulation
- Very low temperature coefficient
- Current and thermal limiting
- Reverse-battery protection
- Zero OFF mode current
- Logic-controlled electronic shutdown
- Available in SO-8 package

Applications

- Cellular Telephones
- Laptop, Notebook, and Palmtop Computers
- Battery Powered Equipment
- PCMCIA V_{CC} and V_{PP} Regulation/Switching
- Bar Code Scanners
- SMPS Post-Regulator/ DC to DC Modules
- High Efficiency Linear Power Supplies

Ordering Information

Part Number	Volts	Accuracy	Temperature Range*	Package
MIC5202-3.0BM	3.0	1%	-40°C to +125°C	SO-8
MIC5202-3.3BM	3.3	1%	-40°C to +125°C	SO-8
MIC5202-4.8BM	4.85	1%	-40°C to +125°C	SO-8
MIC5202-5.0BM	5.0	1%	-40°C to +125°C	SO-8

* Junction Temperature

Other voltages are available; contact Micrel for details.

Pin Configuration

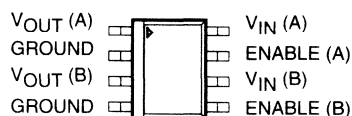

MIC5202-xxBM

Both GROUND pins must be tied to the same potential. V_{IN} (A) and V_{IN} (B) may run from separate supplies.

Typical Application

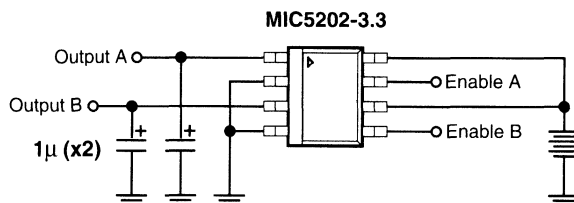

ENABLE pins may be tied directly to V_{IN}

Absolute Maximum Ratings

Absolute Maximum Ratings indicate limits beyond which damage to the device may occur. Electrical specifications do not apply when operating the device beyond its specified **Operating Ratings**.

Power Dissipation	Internally Limited
Lead Temperature (Soldering, 5 seconds)	260°C
Operating Junction Temperature Range	-40°C to +125°C
Input Supply Voltage	-20V to +60V
ENABLE Input Voltage	-20V to +60V
ESD Rating	> 2000V
SO-8 θ_{JA}	See Note 1

Electrical Characteristics

Limits in standard typeface are for $T_J = 25^\circ\text{C}$ and limits in **boldface** apply over the junction temperature range of -40°C to $+125^\circ\text{C}$. Specifications are for each half of the (dual) MIC5202. Unless otherwise specified, $V_{IN} = V_{OUT} + 1\text{V}$, $I_L = 1\text{mA}$, $C_L = 10\mu\text{F}$, and $V_{CONTROL} \geq 2.0\text{V}$.

Symbol	Parameter	Condition	Min	Typ	Max	Units
V_O	Output Voltage	Variation from specified V_{OUT} Accuracy	-1 -2		1 2	%
$\frac{\Delta V_O}{\Delta T}$	Output Voltage Temperature Coef.	(Note 2)		40	150	ppm/°C
$\frac{\Delta V_O}{V_O}$	Line Regulation	$V_{IN} = V_{OUT} + 1\text{V}$ to 26V		0.004	0.10 0.40	%
$\frac{\Delta V_O}{V_O}$	Load Regulation	$I_L = 0.1\text{mA}$ to 100mA (Note 3)		0.04	0.16 0.30	%
$V_{IN} - V_O$	Dropout Voltage (Note 4)	$I_L = 100\mu\text{A}$ $I_L = 20\text{mA}$ $I_L = 30\text{mA}$ $I_L = 50\text{mA}$ $I_L = 100\text{mA}$		17 130 150 180 225	350	mV
I_Q	Quiescent Current	$V_{CONTROL} \leq 0.7\text{V}$ (Shutdown)		0.01		μA
I_{GND}	Ground Pin Current	$V_{CONTROL} \geq 2.0\text{V}$, $I_L = 100\mu\text{A}$ $I_L = 20\text{mA}$ $I_L = 30\text{mA}$ $I_L = 50\text{mA}$ $I_L = 100\text{mA}$		170 270 330 500 1200	1500	μA
PSRR	Ripple Rejection			75		dB
I_{GNDDO}	Ground Pin Current at Dropout	$V_{IN} = 0.5\text{V}$ less specified V_{OUT} , $I_L = 100\mu\text{A}$ (Note 5)		270	330	μA
I_{LIMIT}	Current Limit	$V_{OUT} = 0\text{V}$		280		mA
$\frac{\Delta V_O}{\Delta P_D}$	Thermal Regulation	(Note 6)		0.05		%/W
e_n	Output Noise			100		μV

Control Input

V_{IL}	Input Voltage Level Logic Low Logic High	OFF ON	2.0		0.7	V
I_{IL} I_{IH}	Control Input Current	$V_{IL} \leq 0.7\text{V}$ $V_{IH} \geq 2.0\text{V}$		0.01 8	50	μA

- Note 1:** Absolute maximum ratings indicate limits beyond which damage to the component may occur. Electrical specifications do not apply when operating the device outside of its rated operating conditions. The maximum allowable power dissipation is a function of the maximum junction temperature, $T_{J(MAX)}$, the junction-to-ambient thermal resistance, θ_{JA} , and the ambient temperature, T_A . The maximum allowable power dissipation at any ambient temperature is calculated using: $P_{(MAX)} = (T_{J(MAX)} - T_A) / \theta_{JA}$. Exceeding the maximum allowable power dissipation will result in excessive die temperature, and the regulator will go into thermal shutdown. The junction to ambient thermal resistance of the MIC5202BM is 160°C/W mounted on a PC board.
- Note 2:** Output voltage temperature coefficient is defined as the worst case voltage change divided by the total temperature range.
- Note 3:** Regulation is measured at constant junction temperature using low duty cycle pulse testing. Parts are tested for load regulation in the load range from 0.1mA to 100mA. Changes in output voltage due to heating effects are covered by the thermal regulation specification.
- Note 4:** Dropout Voltage is defined as the input to output differential at which the output voltage drops 2% below its nominal value measured at 1V differential.
- Note 5:** Ground pin current is the regulator quiescent current plus pass transistor base current. The total current drawn from the supply is the sum of the load current plus the ground pin current.
- Note 6:** Thermal regulation is defined as the change in output voltage at a time T after a change in power dissipation is applied, excluding load or line regulation effects. Specifications are for a 100mA load pulse at $V_{IN} = 26V$ for $T = 10ms$, and is measured separately for each section.

Typical Characteristics (Each Regulator—2 Regulators/Package)

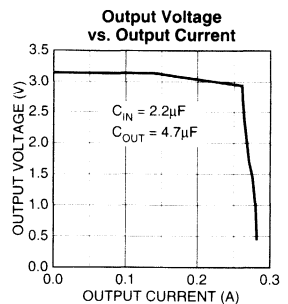
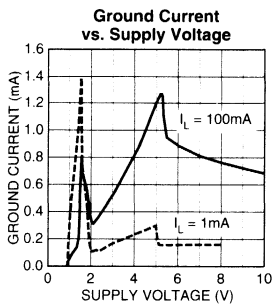
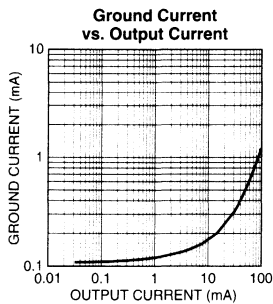
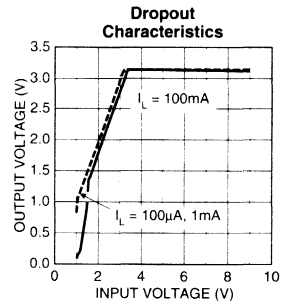
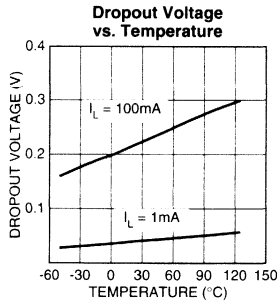
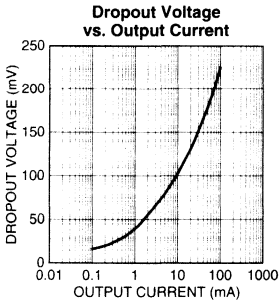

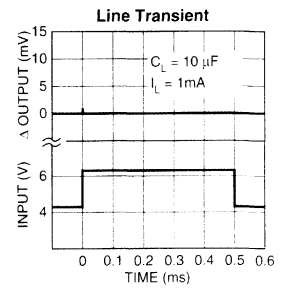
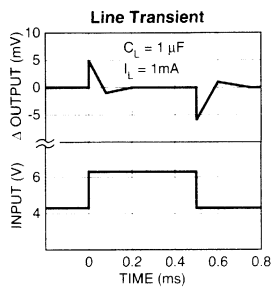
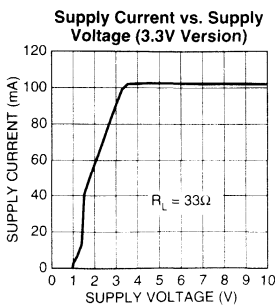
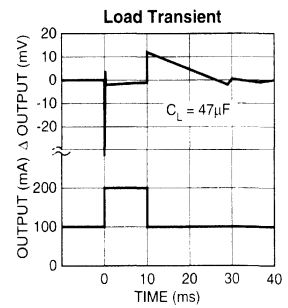
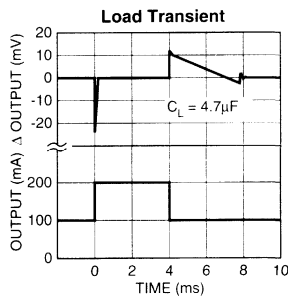
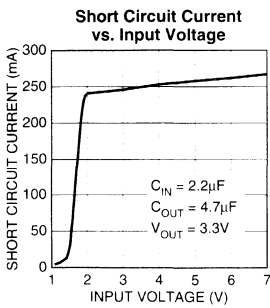
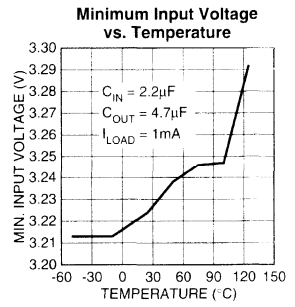
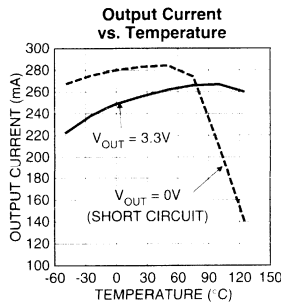
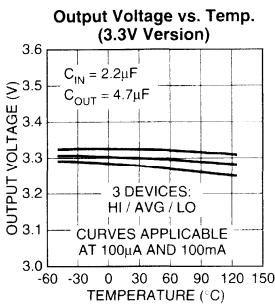
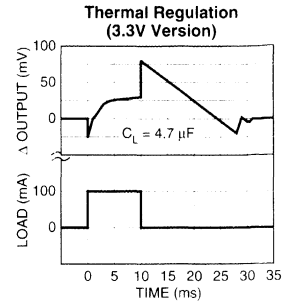
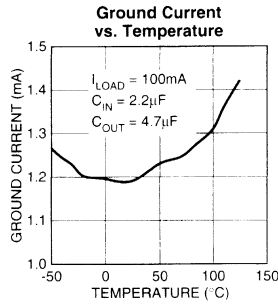
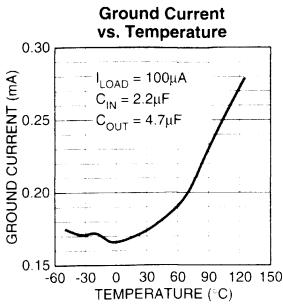

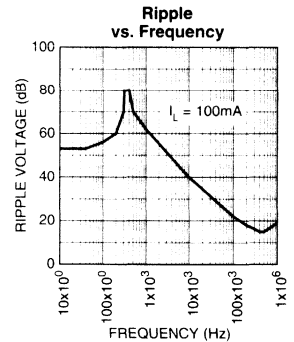
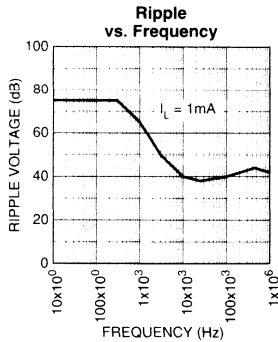
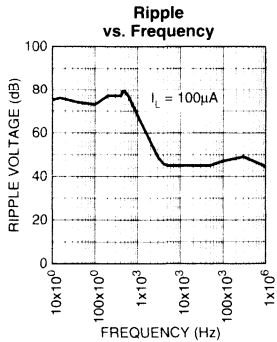
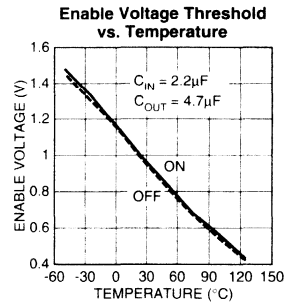
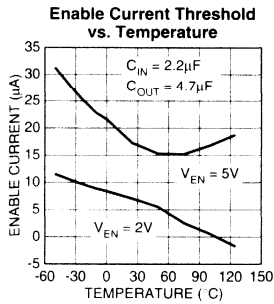
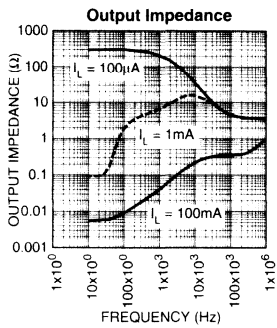
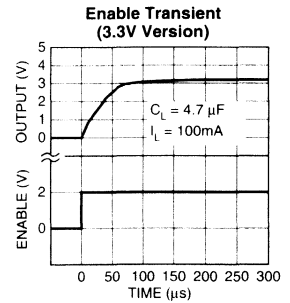
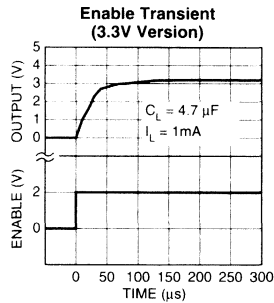
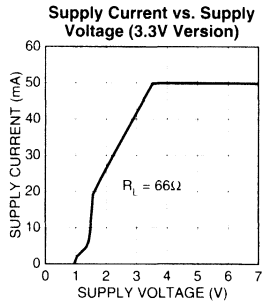

Applications Information

External Capacitors

A 1 μ F capacitor is recommended between the MIC5202 output and ground to prevent oscillations due to instability. Larger values serve to improve the regulator's transient response. Most types of tantalum or aluminum electrolytics will be adequate; film types will work, but are costly and therefore not recommended. Many aluminum electrolytics have electrolytes that freeze at about -30°C , so solid tantalums are recommended for operation below -25°C . The important parameters of the capacitor are an effective series resistance of about 5Ω or less and a resonant frequency above 500kHz. The value of this capacitor may be increased without limit.

At lower values of output current, less output capacitance is required for output stability. The capacitor can be reduced to 0.47 μ F for current below 10mA or 0.33 μ F for currents below 1 mA. A 1 μ F capacitor should be placed from the MIC5202 input to ground if there is more than 10 inches of wire between the input and the AC filter capacitor or if a battery is used as the supply.

ENABLE Input

The MIC5202 features nearly zero OFF mode current. When the ENABLE input is held below 0.7V, all internal circuitry is powered off. Pulling this pin high (over 2.0V) re-enables the device and allows operation. The ENABLE pin requires a small amount of current, typically 15 μ A. While the logic threshold is TTL/CMOS compatible, ENABLE may be pulled as high as 30V, independent of the voltage on V_{IN} . The two portions of the MIC5202 may be enabled separately.

General Notes

The MIC5202 will remain stable and in regulation with no load in addition to the internal voltage divider, unlike many other voltage regulators. This is especially important in CMOS RAM keep-alive applications. Thermal shutdown is independent on both halves of the dual MIC5202, however an over-temperature condition on one half might affect the other because of proximity. When used in dual supply systems where the regulator load is returned to a negative supply, the output voltage must be diode clamped to ground.

Both MIC5202 GROUND pins must be tied to the same ground potential. Isolation between the two halves allows connecting the two V_{IN} pins to different supplies.

Thermal Considerations

Part I. Layout

The MIC5202-xxBM (8-pin surface mount package) has the following thermal characteristics when mounted on a single layer copper-clad printed circuit board.

PC Board Dielectric	θ_{JA}
FR4	160 $^{\circ}\text{C}/\text{W}$
Ceramic	120 $^{\circ}\text{C}/\text{W}$

Multi-layer boards having a ground plane, wide traces near the pads, and large supply bus lines provide better thermal conductivity.

The "worst case" value of 160 $^{\circ}\text{C}/\text{W}$ assumes no ground plane, minimum trace widths, and a FR4 material board.

Part II. Nominal Power Dissipation and Die Temperature

The MIC5202-xxBM at a 25 $^{\circ}\text{C}$ ambient temperature will operate reliably at up to 625mW power dissipation when mounted in the "worst case" manner described above. At an ambient temperature of 55 $^{\circ}\text{C}$, the device may safely dissipate 440mW. These power levels are equivalent to a die temperature of 125 $^{\circ}\text{C}$, the recommended maximum temperature for non-military grade silicon integrated circuits.

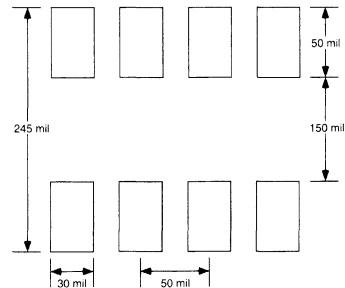

Minimum recommended board pad size, SO-8.

General Description

The LP2950 and LP2951 are micropower voltage regulators with very low dropout voltage (typically 40mV at light loads and 380mV at 100mA), and very low quiescent current (75µA typical). The quiescent current of the LP2950/LP2951 increases only slightly in dropout, thus prolonging battery life. This feature, among others, makes the LP2950 and LP2951 ideally suited for use in battery-powered systems.

Available in a 3-Pin TO-92 package, the LP2950 is pin-compatible with the older 5V regulators. Additional system functions, such as programmable output voltage and logic-controlled shutdown, are available in the 8-pin DIP and 8-pin SOIC versions of the LP2951.

Applications

- Automotive Electronics
- Voltage Reference
- Avionics

Features

- High accuracy 5V, guaranteed 100 mA output
- Extremely low quiescent current
- Low dropout voltage
- Extremely tight load and line regulation
- Very low temperature coefficient
- Use as regulator or reference
- Needs only 1µF for stability
- Current and thermal limiting

LP2951 Versions Only

- Error flag warns of output dropout
- Logic-controlled electronic shutdown
- Output programmable from 1.24 to 29V

† Summary Information. Please refer to Micrel's full-line Databook for complete details.

Block Diagram and Pin Configurations

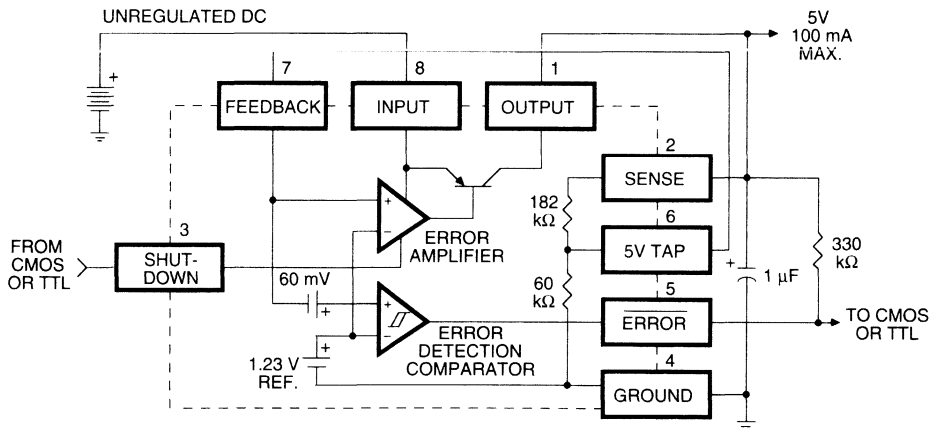

LP2950 and LP2951 Block Diagram
(Pin Numbers Refer to LP2951)

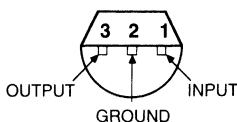

TO-92 Plastic Package Bottom View
(BZ)

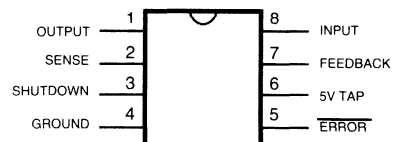

DIP and SO Packages
(BN, and BM)

See MIC2950 for a part with 1) higher output (150 mA), 2) transient protection (60V), and 3) reverse input protection to -20V

General Description

The MIC2950 and MIC2951 are "bulletproof" micropower voltage regulators with very low dropout voltage (typically 40mV at light loads and 250mV at 100mA), and very low quiescent current. Like their predecessors, the LP2950 and LP2951, the quiescent current of the MIC2950/MIC2951 increases only slightly in dropout, thus prolonging battery life. The MIC2950/MIC2951 are pin for pin compatible with the LP2950/LP2951, but offer lower dropout, lower quiescent current, reverse battery, and automotive load dump protection.

The key additional features and protection offered include higher output current (150mA), positive transient protection for up to 60V (load dump), and the ability to survive an unregulated input voltage transient of -20V below ground (reverse battery).

The plastic DIP and SOIC versions offer additional system functions such as programmable output voltage and logic controlled shutdown. The 3-pin TO-92 MIC2950 is pin-compatible with the older 5V regulators.

These system functions also include an error flag output that warns of a low output voltage, which is often due to failing batteries on the input. This may also be used as a power-on reset. A logic-compatible shutdown input is also available which enables the regulator to be switched on and off. This part may also be pin-strapped for a 5V output, or programmed from 1.24V to 29V with the use of two external resistors.

Features

- High accuracy 3.3, 4.85, or 5V, guaranteed 150mA output
- Extremely low quiescent current
- Low-dropout voltage
- Extremely tight load and line regulation
- Very low temperature coefficient
- Use as regulator or reference
- Needs only $1.5\mu\text{F}$ for stability
- Current and thermal limiting
- Unregulated DC input can withstand -20V reverse battery and $+60\text{V}$ positive transients
- Error flag warns of output dropout (MIC2951)
- Logic-controlled electronic shutdown (MIC2951)
- Output programmable from 1.24V to 29V (MIC2951)

Applications

- Automotive Electronics
- Battery Powered Equipment
- Cellular Telephones
- SMPS Post-Regulator
- Voltage Reference
- Avionics
- High Efficiency Linear Power Supplies

Block Diagram

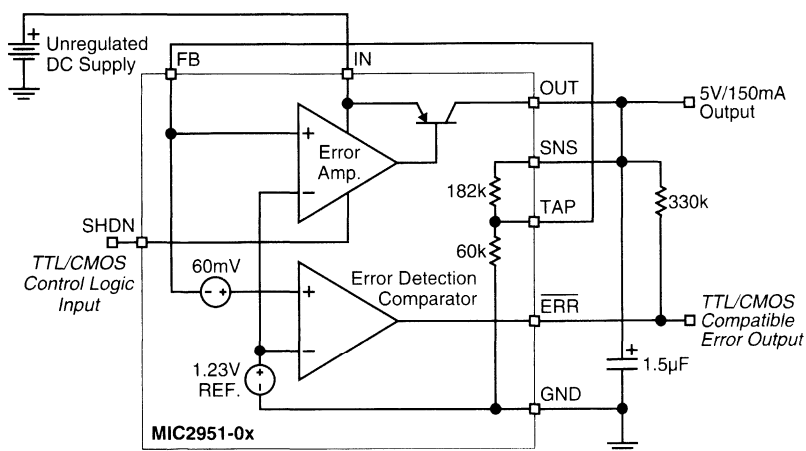

The MIC2950 is available as either an -05 or -06 version. The -05 and -06 versions are guaranteed for junction temperatures from -40°C to $+125^{\circ}\text{C}$; the -05 version has a tighter output and reference voltage specification range over temperature. The MIC2951 is available as an -01, -02, or -03 version. The -01 version is guaranteed for junction temperatures from -55°C to $+150^{\circ}\text{C}$, and has slightly different specifications limits over the full operating temperature range.

The MIC2950 and MIC2951 have a tight initial tolerance (0.5% typical), a very low output voltage temperature coefficient which allows use as a low-power voltage reference, and extremely good load and line regulation (0.04% typical). This greatly reduces the error in the overall circuit, and is the result of careful design techniques and process control.

Ordering Information

Part Number	Voltage	Accuracy	Temperature Range*	Package
MIC2950-05BZ	5.0V	0.5%	-40°C to $+125^{\circ}\text{C}$	TO-92
MIC2950-06BZ	5.0V	1.0%	-40°C to $+125^{\circ}\text{C}$	TO-92
MIC2951-02BM	5.0V	0.5%	-40°C to $+125^{\circ}\text{C}$	8-pin SOIC
MIC2951-03BM	5.0V	1.0%	-40°C to $+125^{\circ}\text{C}$	8-pin SOIC
MIC2951-02BN	5.0V	0.5%	-40°C to $+125^{\circ}\text{C}$	8-pin plastic DIP
MIC2951-03BN	5.0V	1.0%	-40°C to $+125^{\circ}\text{C}$	8-pin plastic DIP
MIC2951-03BMM	5.0V	1.0%	-40°C to $+125^{\circ}\text{C}$	8-lead MM8™
MIC2951-3.3BM	3.3V	1.0%	-40°C to $+125^{\circ}\text{C}$	8-pin SOIC
MIC2951-4.8BM	4.85V	1.0%	-40°C to $+125^{\circ}\text{C}$	8-pin SOIC

* junction temperature

Pin Configuration

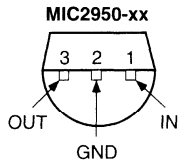

TO-92 (Z)
(Bottom View)

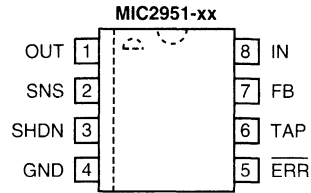

DIP (N), SOIC (M), MM8™ (MM)
(Top View)

Pin Description

Pin # MIC2950	Pin # MIC2951	Pin Name	Pin Function
3	1	OUT	Regulated Output
	2	SNS	Sense (Input): Output-voltage sensing end of internal voltage divider for fixed 5V operation. Not used in adjustable configuration.
	3	SHDN	Shutdown/Enable (Input): TTL compatible input. High = shutdown, low or open = enable.
2	4	GND	Ground
	5	$\overline{\text{ERR}}$	Error Flag (Output): Active low, open-collector output (low = error, floating = normal).
	6	TAP	3.3V/4.85V/5V Tap: Output of internal voltage divider when the regulator is configured for fixed operation. Not used in adjustable configuration.
	7	FB	Feedback (Input): 1.235V feedback from internal voltage divider's TAP (for fixed operation) or external resistor network (adjustable configuration).
1	8	IN	Unregulated Supply Input

Absolute Maximum Ratings

Input Supply Voltage (V_{IN}) Note 2	-20V to +60V
Feedback Input Voltage (V_{FB}) Note 3, 4	-1.5V to +26V
Shutdown Input Voltage (V_{SHDN}) Note 3	-0.3V to +30V
Power Dissipation (P_{D}) Note 1	Internally Limited
Storage Temperature	-65°C to +150°C
Lead Temperature (soldering, 5 secs.)	260°C

Operating Ratings

Input Supply Voltage (V_{IN})	+2.0V to +30V
Junction Temperature (T_{J})	Note 1
MIC2951-01	-55°C to +150°C
MIC2950-05/MIC2950-06	-40°C to +125°C
MIC2951-02/MIC2950-03	-40°C to +125°C

Electrical Characteristics Note 5, 6 $T_A = 25^\circ\text{C}$ except as noted.

Parameter	Condition	Min	Typ	Max	Units
Output Voltage $T_J = 25^\circ\text{C}$	MIC2951-01 ($\pm 0.5\%$)	4.975	5.000	5.025	V
	MIC295x-02/-05 ($\pm 0.5\%$)	4.975	5.000	5.025	V
	MIC295x-03/-06 ($\pm 1\%$)	4.950	5.000	5.050	V
	MIC2951-3.3 ($\pm 1\%$)	3.267	3.300	3.333	V
	MIC2951-4.8 ($\pm 1\%$)	4.802	4.850	4.899	V
Output Voltage $-25^\circ\text{C} \leq T_J \leq +85^\circ\text{C}$	MIC295x-02/-05 ($\pm 0.5\%$)	4.950		5.050	V
	MIC295x-03/-06 ($\pm 1\%$)	4.925		5.075	V
	MIC2951-3.3 ($\pm 1\%$)	3.251		3.350	V
	MIC2951-4.8 ($\pm 1\%$)	4.777		4.872	V
Output Voltage Over Full Temperature Range	MIC2951-01 ($\pm 0.5\%$), -55°C to $+160^\circ\text{C}$	4.940		5.060	V
	MIC295x-02/-05 ($\pm 0.5\%$), -40°C to $+125^\circ\text{C}$	4.940		5.060	V
	MIC295x-03/-06 ($\pm 1\%$), -40°C to $+125^\circ\text{C}$	4.900		5.100	V
	MIC2951-3.3 ($\pm 1\%$), -40°C to $+125^\circ\text{C}$	3.234		3.366	V
	MIC2951-4.8 ($\pm 1\%$), -40°C to $+125^\circ\text{C}$	4.753		4.947	V
Output Voltage Over Load Variation	MIC2951-01 ($\pm 0.5\%$), $100\mu\text{A} \leq I_L \leq 150\text{mA}$, $T_J \leq T_{J(\text{max})}$	4.925		5.075	V
	MIC295x-02/-05 ($\pm 0.5\%$), $100\mu\text{A} \leq I_L \leq 150\text{mA}$, $T_J \leq T_{J(\text{max})}$	4.930		5.070	V
	MIC295x-03/-06 ($\pm 1\%$), $100\mu\text{A} \leq I_L \leq 150\text{mA}$, $T_J \leq T_{J(\text{max})}$	4.880		5.120	V
	MIC2951-3.3 ($\pm 1\%$), $100\mu\text{A} \leq I_L \leq 150\text{mA}$, $T_J \leq T_{J(\text{max})}$	3.221		3.379	V
	MIC2951-4.8 ($\pm 1\%$), $100\mu\text{A} \leq I_L \leq 150\text{mA}$, $T_J \leq T_{J(\text{max})}$	4.733		4.967	V
Output Voltage Temperature Coefficient	MIC2951-01 ($\pm 0.5\%$), Note 7		20	120	ppm/ $^\circ\text{C}$
	MIC295x-02/-05 ($\pm 0.5\%$), Note 7		20	100	ppm/ $^\circ\text{C}$
	MIC295x-03/-06 ($\pm 1\%$), Note 7		50	150	ppm/ $^\circ\text{C}$
	MIC2951-3.3 ($\pm 1\%$), Note 7		50	150	ppm/ $^\circ\text{C}$
	MIC2951-4.8 ($\pm 1\%$), Note 7		50	150	ppm/ $^\circ\text{C}$
Line Regulation	MIC2951-01 ($\pm 0.5\%$), Note 8, 9		0.03	0.10 0.50	% %
	MIC295x-02/-05 ($\pm 0.5\%$), Note 8, 9		0.03	0.10 0.20	% %
	MIC295x-03/-06 ($\pm 1\%$), Note 8, 9		0.04	0.20 0.40	% %
	MIC2951-3.3 ($\pm 1\%$), Note 8, 9		0.04	0.20 0.40	% %
	MIC2951-4.8 ($\pm 1\%$), Note 8, 9		0.04	0.20 0.40	% %
Load Regulation	MIC2951-01 ($\pm 0.5\%$), $100\mu\text{A} \leq I_L \leq 150\text{mA}$, Note 8		0.04	0.10 0.30	% %
	MIC295x-02/-05 ($\pm 0.5\%$), $100\mu\text{A} \leq I_L \leq 150\text{mA}$, Note 8		0.04	0.10 0.20	% %
	MIC295x-03/-06 ($\pm 1\%$), $100\mu\text{A} \leq I_L \leq 150\text{mA}$, Note 8		0.10	0.20 0.30	% %
	MIC2951-3.3 ($\pm 1\%$), $100\mu\text{A} \leq I_L \leq 150\text{mA}$, Note 8		0.10	0.20 0.30	% %
	MIC2951-4.8 ($\pm 1\%$), $100\mu\text{A} \leq I_L \leq 150\text{mA}$, Note 8		0.10	0.20 0.30	% %

Parameter	Condition	Min	Typ	Max	Units
Dropout Voltage	MIC2951-01/-02/-03/-05/-06, $I_L = 100\mu\text{A}$, Note 10		40	80 140	mV mV
	MIC2951-01/-02/-03/-05/-06, $I_L = 100\text{mA}$, Note 10		250	300	mV
	MIC2951-01/-02/-03/-05/-06, $I_L = 150\text{mA}$, Note 10		300	450 600	mV mV
	MIC2951-3.3 ($\pm 1\%$), $I_L = 100\mu\text{A}$, Note 10		40	80 150	mV mV
	MIC2951-3.3 ($\pm 1\%$), $I_L = 100\text{mA}$, Note 10		250	350	mV
	MIC2951-3.3 ($\pm 1\%$), $I_L = 150\text{mA}$, Note 10		320	450 600	mV mV
	MIC2951-4.8 ($\pm 1\%$), $I_L = 100\mu\text{A}$, Note 10		40	80 140	mV mV
	MIC2951-4.8 ($\pm 1\%$), $I_L = 100\text{mA}$, Note 10		250	300	mV
	MIC2951-4.8 ($\pm 1\%$), $I_L = 150\text{mA}$, Note 10		300	450 600	mV mV
Ground Current	MIC2951-01/-02/-03/-05/-06, $I_L = 100\mu\text{A}$		120	180 300	μA μA
	MIC2951-01/-02/-03/-05/-06, $I_L = 100\text{mA}$		1.7	2.5 3.5	mA mA
	MIC2951-01/-02/-03/-05/-06, $I_L = 150\text{mA}$		4	6 8	mA mA
	MIC2951-3.3 ($\pm 1\%$), $I_L = 100\mu\text{A}$		100	180 300	μA μA
	MIC2951-3.3 ($\pm 1\%$), $I_L = 100\text{mA}$		1.7	2.5	mA
	MIC2951-3.3 ($\pm 1\%$), $I_L = 150\text{mA}$		4	6 10	mA mA
	MIC2951-4.8 ($\pm 1\%$), $I_L = 100\mu\text{A}$		120	180 300	μA μA
	MIC2951-4.8 ($\pm 1\%$), $I_L = 100\text{mA}$		1.7	2.5 3.5	mA mA
	MIC2951-4.8 ($\pm 1\%$), $I_L = 150\text{mA}$		4	6 8	mA mA
Dropout Ground Current	MIC2951-01 ($\pm 0.5\%$), $V_{IN} = 4.5\text{V}$, $I_L = 100\mu\text{A}$		280	400	μA μA
	MIC295x-02/-03/-05/-06 ($\pm 0.5\%$), $V_{IN} = 4.5\text{V}$, $I_L = 100\mu\text{A}$		280	350 400	μA μA
	MIC2951-3.3 ($\pm 1\%$), $V_{IN} = 3.0\text{V}$, $I_L = 100\mu\text{A}$		150	350 400	μA μA
	MIC295x-4.8 ($\pm 1\%$), $V_{IN} = 4.3\text{V}$, $I_L = 100\mu\text{A}$		280	350 400	μA μA
Current Limit	$V_{OUT} = 0\text{V}$		240	300 350	mA mA
Thermal Regulation	Note 11		0.05	0.20	%/W
Output Noise	10Hz to 100kHz, $C_L = 1.5\mu\text{F}$		430		μV_{RMS}
	10Hz to 100kHz, $C_L = 200\mu\text{F}$		160		μV_{RMS}
	10Hz to 100kHz, $C_L = 3.3\mu\text{F}$, 0.01 μF bypass Feedback to Output		100		μV_{RMS}

Parameter	Condition	Min	Typ	Max	Units
Reference Voltage	MIC2951-01 ($\pm 0.5\%$)	1.220 1.200	1.235	1.250 1.260	V V
	MIC295x-02/-05 ($\pm 0.5\%$)	1.220 1.200	1.235	1.250 1.260	V V
	MIC295x-03/-06 ($\pm 1\%$)	1.210 1.200	1.235	1.260 1.270	V V
	MIC2951-3.3 ($\pm 1\%$)	1.210 1.200	1.235	1.260 1.270	V V
	MIC2951-4.8 ($\pm 1\%$)	1.210 1.200	1.235	1.260 1.270	V V
Reference Voltage	MIC2951-01 ($\pm 0.5\%$), Note 12	1.190		1.270	V
	MIC295x-02/-05 ($\pm 0.5\%$), Note 12	1.190		1.270	V
	MIC295x-03/-06 ($\pm 1\%$), Note 12	1.185		1.285	V
	MIC2951-3.3 ($\pm 1\%$), Note 12	1.185		1.285	V
	MIC2951-4.8 ($\pm 1\%$), Note 12	1.185		1.285	V
Feedback Bias Current			20 40 60	nA nA	
Reference Voltage	MIC2951-01 ($\pm 0.5\%$), Note 7		20		ppm/ $^{\circ}$ C
Temperature Coefficient	MIC295x-02/-05 ($\pm 0.5\%$), Note 7		20		ppm/ $^{\circ}$ C
	MIC295x-03/-06 ($\pm 1\%$), Note 7		50		ppm/ $^{\circ}$ C
	MIC2951-3.3 ($\pm 1\%$), Note 7		50		ppm/ $^{\circ}$ C
	MIC2951-4.8 ($\pm 1\%$), Note 7		50		ppm/ $^{\circ}$ C
Feedback Bias Current Temperature Coefficient			0.1		nA/ $^{\circ}$ C
Error Comparator (Flag) Output Leakage Current	$V_{OH} = 30V$		0.01	1.00 2.00	μ A μ A
Error Comparator (Flag) Output Low Voltage	$V_{IN} = 4.5V, I_{OL} = 200\mu A$		150	250 400	mV mV
Error Comparator Upper Threshold Voltage	Note 13	40 25	60		mV mV
Error Comparator Lower Threshold Voltage	Note 13		75	95 140	mV mV
Error Comparator Hysteresis	Note 13		15		mV
Shutdown Input Logic Voltage	MIC2951-01 ($\pm 0.5\%$) Low High		1.3	0.6	V V V
	MIC295x-02/-05 ($\pm 0.5\%$) Low High		1.3	0.7	V V V
	MIC295x-03/-06 ($\pm 1\%$) Low High		1.3	0.7	V V V
	MIC2951-3.3 ($\pm 1\%$) Low High		1.3	0.7	V V V
	MIC2951-4.8 ($\pm 1\%$) Low High		1.3	0.7	V V V
	MIC2951-01 ($\pm 0.5\%$) Low High	2.0			V V V
	MIC295x-02/-05 ($\pm 0.5\%$) Low High	2.0			V V V
	MIC295x-03/-06 ($\pm 1\%$) Low High	2.0			V V V
	MIC2951-3.3 ($\pm 1\%$) Low High	2.0			V V V
	MIC2951-4.8 ($\pm 1\%$) Low High	2.0			V V V

Parameter	Condition	Min	Typ	Max	Units
Shutdown Input Current	$V_{\text{SHUTDOWN}} = 2.4\text{V}$		30	50 100	μA μA
	$V_{\text{SHUTDOWN}} = 30\text{V}$		450	600 750	μA μA
Regulator Output Current in Shutdown	Note 4		3	10 20	μA μA

General Note: Devices are ESD protected; however, handling precautions are recommended.

- Note 1:** The junction-to-ambient thermal resistance of the TO-92 package is 180°C/W with 0.4" leads and 160°C/W with 0.25" leads to a PC board. The thermal resistance of the 8-pin DIP package is 105°C/W junction-to-ambient when soldered directly to a PC board. Junction-to-ambient thermal resistance for the SOIC (M) package is 160°C/W. Junction-to-ambient thermal resistance for the MM8™ (MM) is 250°C/W.
- Note 2:** The maximum positive supply voltage of 60V must be of limited duration ($\leq 100\text{ms}$) and duty cycle ($\leq 1\%$). The maximum continuous supply voltage is 30V.
- Note 3:** When used in dual-supply systems where the output terminal sees loads returned to a negative supply, the output voltage should be diode-clamped to ground.
- Note 4:** $V_{\text{SHUTDOWN}} \geq 2\text{V}$, $V_{\text{IN}} \leq 30\text{V}$, $V_{\text{OUT}} = 0$, with Feedback pin tied to 5V Tap.
- Note 5:** Boldface limits apply at temperature extremes.
- Note 6:** Unless otherwise specified all limits guaranteed for $T_J = 25^\circ\text{C}$, $V_{\text{IN}} = 6\text{V}$, $I_L = 100\mu\text{A}$ and $C_L = 1\mu\text{F}$. Additional conditions for the 8-pin versions are Feedback tied to 5V Tap and Output tied to Output Sense ($V_{\text{OUT}} = 5\text{V}$) and $V_{\text{SHUTDOWN}} \leq 0.8\text{V}$.
- Note 7:** Output or reference voltage temperature coefficient is defined as the worst case voltage change divided by the total temperature range.
- Note 8:** Regulation is measured at constant junction temperature, using pulse testing with a low duty cycle. Changes in output voltage due to heating effects are covered in the specification for thermal regulation.
- Note 9:** Line regulation for the MIC2951 is tested at 150°C for $I_L = 1\text{mA}$. For $I_L = 100\mu\text{A}$ and $T_J = 125^\circ\text{C}$, line regulation is guaranteed by design to 0.2%. See Typical Performance Characteristics for line regulation versus temperature and load current.
- Note 10:** Dropout voltage is defined as the input to output differential at which the output voltage drops 100mV below its nominal value measured at 1V differential. At very low values of programmed output voltage, the minimum input supply voltage of 2V (2.3V over temperature) must be taken into account.
- Note 11:** Thermal regulation is defined as the change in output voltage at a time T after a change in power dissipation is applied, excluding load or line regulation effects. Specifications are for a 50mA load pulse at $V_{\text{IN}} = 30\text{V}$ (1.25W pulse) for $t = 10\text{ms}$.
- Note 12:** $V_{\text{REF}} \leq V_{\text{OUT}} \leq (V_{\text{IN}} - 1\text{V})$, $2.3\text{V} \leq V_{\text{IN}} \leq 30\text{V}$, $100\mu\text{A} < I_L \leq 150\text{mA}$, $T_J \leq T_{\text{JMAX}}$.
- Note 13:** Comparator thresholds are expressed in terms of a voltage differential at the Feedback terminal below the nominal reference voltage measured at 6V input. To express these thresholds in terms of output voltage change, multiply by the error amplifier gain = $V_{\text{OUT}}/V_{\text{REF}} = (R1 + R2)/R2$. For example, at a programmed output voltage of 5V, the Error output is guaranteed to go low when the output drops by $95\text{mV} \times 5\text{V}/1.235\text{V} = 384\text{mV}$. Thresholds remain constant as a percent of V_{OUT} as V_{OUT} is varied, with the dropout warning occurring at typically 5% below nominal, 7.5% guaranteed.

Typical Characteristics

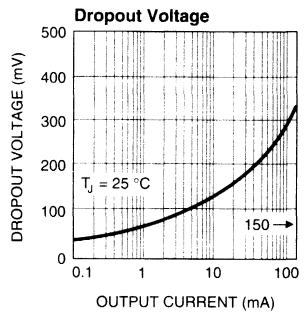
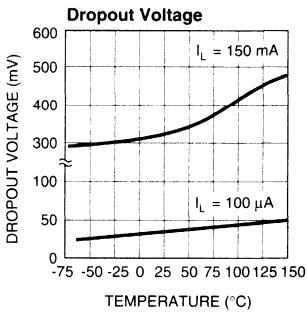
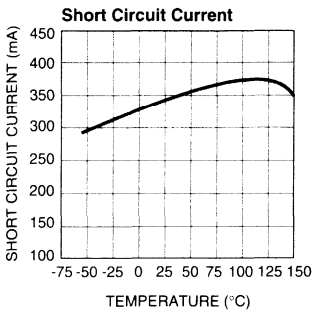
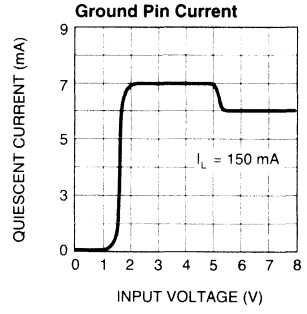
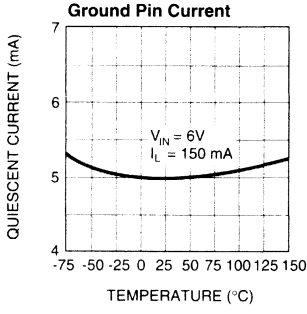
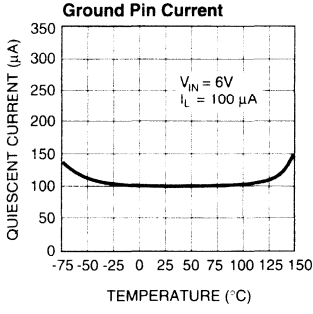
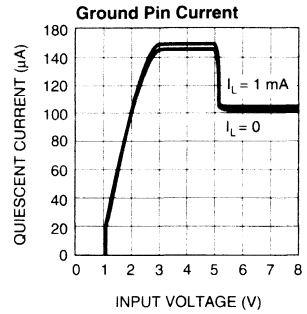
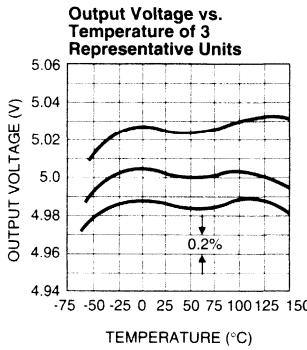
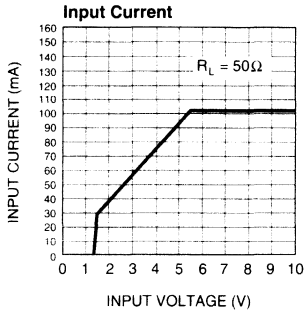
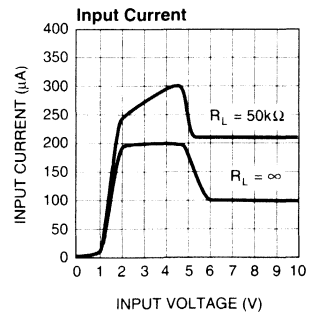
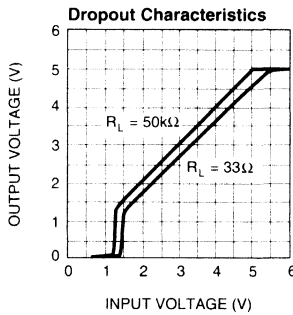
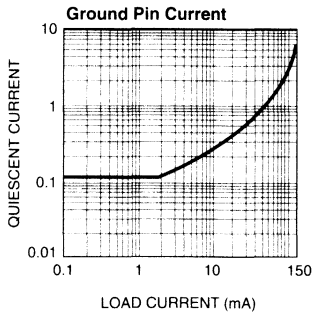

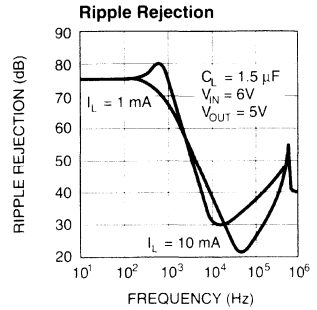
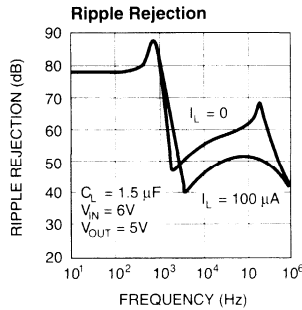
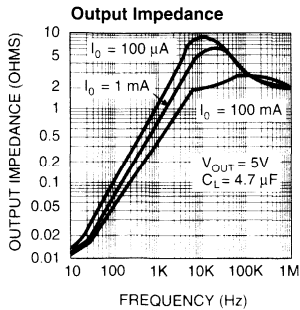
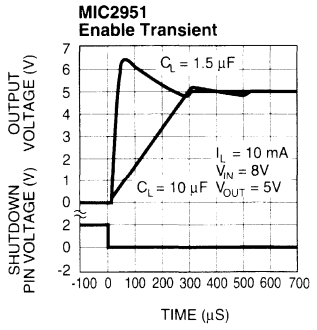
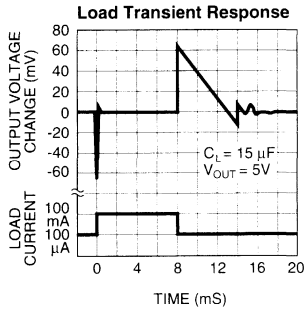
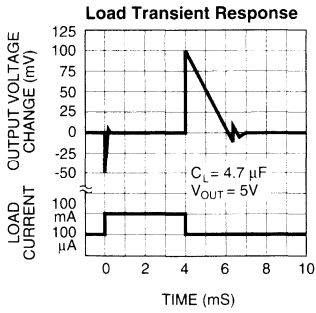
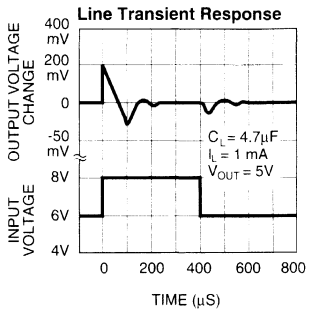
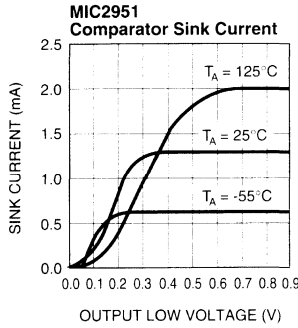
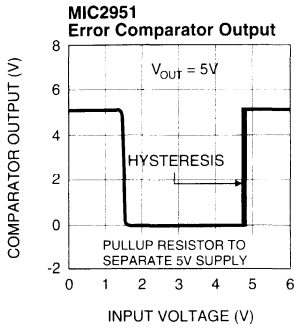
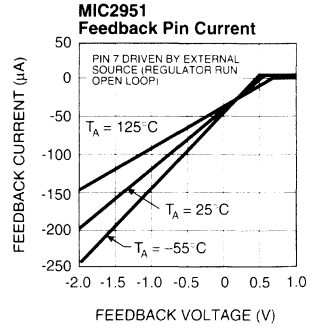
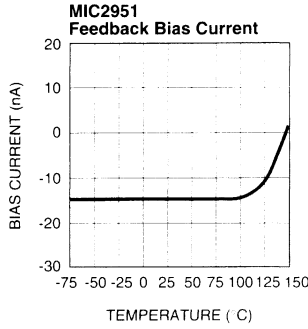
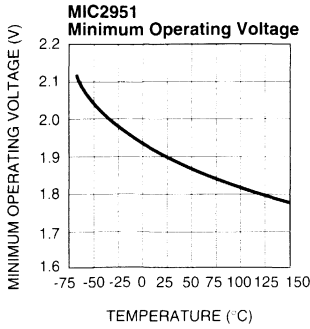

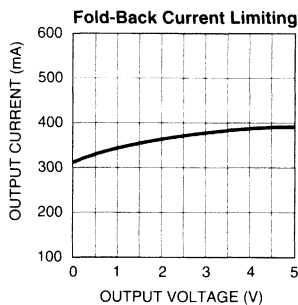
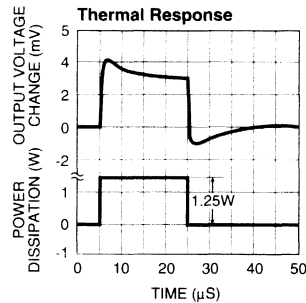
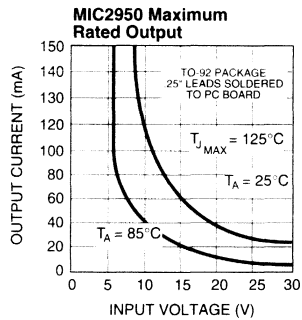
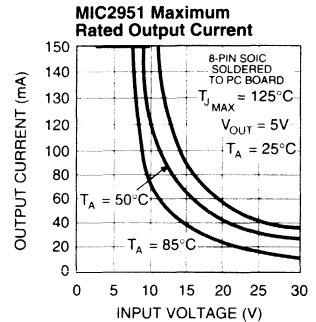
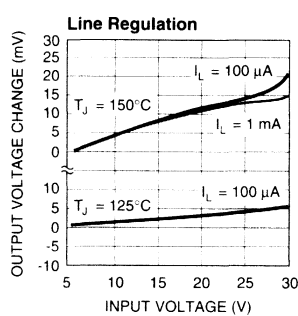
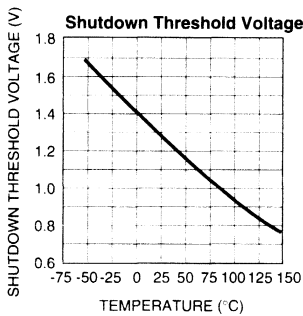
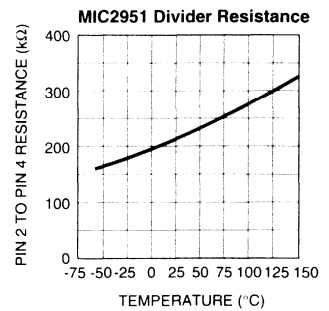
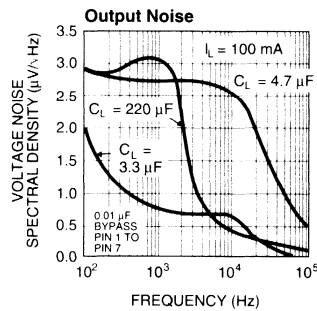
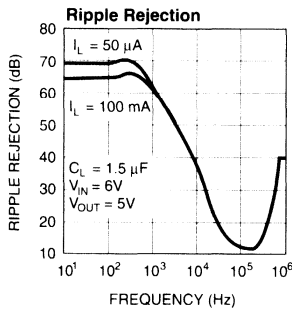

Applications Information

Automotive Applications

The MIC2950/2951 are ideally suited for automotive applications for a variety of reasons. They will operate over a wide range of input voltages, have very low dropout voltages (40mV at light loads), and very low quiescent currents. These features are necessary for use in battery powered systems, such as automobiles. They are also “bulletproof” devices; with the ability to survive both reverse battery (negative transients up to 20V below ground), and load dump (positive transients up to 60V) conditions. A wide operating temperature range with low temperature coefficients is yet another reason to use these versatile regulators in automotive designs.

External Capacitors

A 1.5 μF (or greater) capacitor is required between the MIC2950/MIC2951 output and ground to prevent oscillations due to instability. Most types of tantalum or aluminum electrolytics will be adequate; film types will work, but are costly and therefore not recommended. Many aluminum electrolytics have electrolytes that freeze at about -30°C , so solid tantalums are recommended for operation below -25°C . The important parameters of the capacitor are an effective series resistance of about 5Ω or less and a resonant frequency above 500kHz. The value of this capacitor may be increased without limit.

At lower values of output current, less output capacitance is required for output stability. The capacitor can be reduced to 0.5 μF for current below 10mA or 0.15 μF for currents below 1 mA. Using the 8-pin versions at voltages below 5V runs the error amplifier at lower gains so that more output capacitance is needed. For the worst-case situation of a 150mA load at 1.23V output (Output shorted to Feedback) a 5 μF (or greater) capacitor should be used.

The MIC2950 will remain stable and in regulation with no load in addition to the internal voltage divider, unlike many other voltage regulators. This is especially important in CMOS RAM keep-alive applications. When setting the output voltage of the MIC2951 version with external resistors, a minimum load of 1 μA is recommended.

A 0.1 μF capacitor should be placed from the MIC2950/MIC2951 input to ground if there is more than 10 inches of wire between the input and the AC filter capacitor or if a battery is used as the input.

Stray capacitance to the MIC2951 Feedback terminal (pin 7) can cause instability. This may especially be a problem when using high value external resistors to set the output voltage. Adding a 100pF capacitor between Output and Feedback and increasing the output capacitor to at least 3.3 μF will fix this.

Error Detection Comparator Output

A logic low output will be produced by the comparator whenever the MIC2951 output falls out of regulation by more than approximately 5%. This figure is the comparator's built-in offset of about 60mV divided by the 1.235V reference voltage.

(Refer to the block diagram on Page 1). This trip level remains “5% below normal” regardless of the programmed output voltage of the MIC2951. For example, the error flag trip level is typically 4.75V for a 5V output or 11.4V for a 12V output. The out of regulation condition may be due either to low input voltage, current limiting, thermal limiting, or overvoltage on input (over approximately 38V).

Figure 1 is a timing diagram depicting the $\overline{\text{ERROR}}$ signal and the regulated output voltage as the MIC2951 input is ramped up and down. The $\overline{\text{ERROR}}$ signal becomes valid (low) at about 1.3V input. It goes high at about 5V input (the input voltage at which $V_{\text{OUT}} = 4.75$ —for 5.0V applications). Since the MIC2951's dropout voltage is load-dependent (see curve in Typical Performance Characteristics), the input voltage trip point (about 5V) will vary with the load current. The output voltage trip point does not vary with load.

The error comparator has an open-collector output which requires an external pull-up resistor. Depending on system requirements, this resistor may be returned to the output or some other supply voltage. In determining a value for this resistor, note that while the output is rated to sink 200 μA , this sink current adds to battery drain in a low battery condition. Suggested values range from 100k to 1M Ω . The resistor is not required if this output is unused.

Programming the Output Voltage (MIC2951)

The MIC2951 may be pin-strapped for 5V (or 3.3V or 4.85V) using its internal voltage divider by tying Pin 1 (output) to Pin 2 (sense) and Pin 7 (feedback) to Pin 6 (5V Tap). Alternatively, it may be programmed for any output voltage between its 1.235V reference and its 30V maximum rating. An external pair of resistors is required, as shown in Figure 2.

The complete equation for the output voltage is

$$V_{\text{OUT}} = V_{\text{REF}} \times \{ 1 + R_1/R_2 \} + I_{\text{FB}} R_1$$

where V_{REF} is the nominal 1.235 reference voltage and I_{FB} is the feedback pin bias current, nominally -20nA . The minimum recommended load current of 1 μA forces an upper limit of 1.2M Ω on the value of R_2 , if the regulator must work with no load (a condition often found in CMOS in standby), I_{FB} will produce a 2% typical error in V_{OUT} which may be eliminated at room temperature by trimming R_1 . For better accuracy, choosing $R_2 = 100\text{k}$ reduces this error to 0.17% while increasing the resistor program current to 12 μA .

Reducing Output Noise

In some applications it may be advantageous to reduce the AC noise present at the output. One method is to reduce the regulator bandwidth by increasing the size of the output capacitor. This is the only method by which noise can be reduced on the 3 lead MIC2950 and is relatively inefficient, as increasing the capacitor from 1 μF to 220 μF only decreases the noise from 430 μV to 160 μV rms for a 100kHz bandwidth at 5V output.

Noise can be reduced fourfold by a bypass capacitor across R_1 , since it reduces the high frequency gain from 4 to unity. Pick:

$$C_{BYPASS} \cong \frac{1}{2\pi R_1 \cdot 200 \text{ Hz}}$$

or about 0.01 μF . When doing this, the output capacitor must be increased to 3.3 μF to maintain stability. These changes reduce the output noise from 430 μV to 100 μV rms for a 100 kHz bandwidth at 5V output. With the bypass capacitor added, noise no longer scales with output voltage so that improvements are more dramatic at higher output voltages.

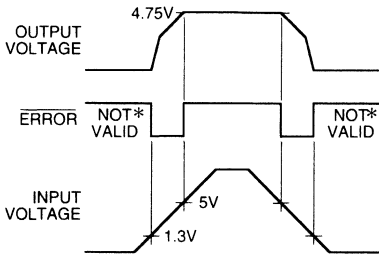

* SEE APPLICATIONS INFORMATION

Figure 1. ERROR Output Timing

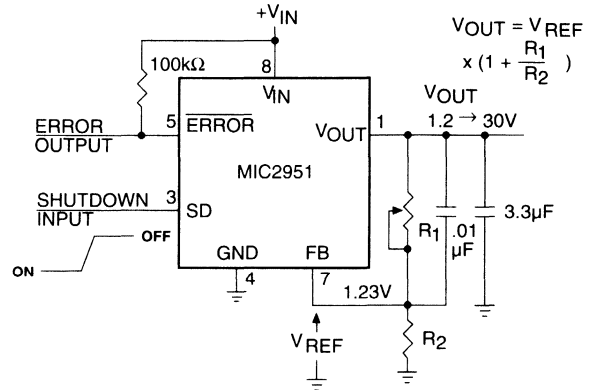

NOTE: PINS 2 AND 6 ARE LEFT OPEN

*SEE APPLICATIONS INFORMATION

Figure 2. Adjustable Regulator

Typical Applications

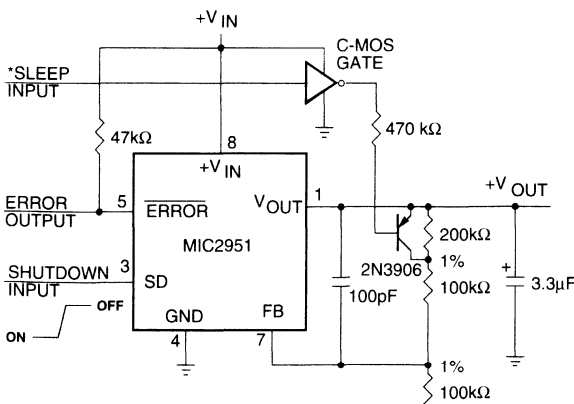

*HIGH INPUT LOWERS V_{OUT} TO 2.5V

5 V Regulator with 2.5 V Sleep Function

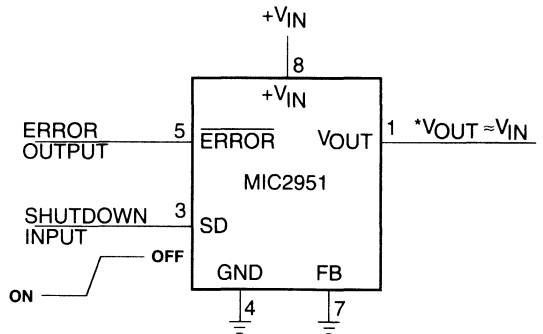

*MINIMUM INPUT-OUTPUT VOLTAGE RANGES FROM 40mV TO 400mV, DEPENDING ON LOAD CURRENT.

Wide Input Voltage Range Current Limiter

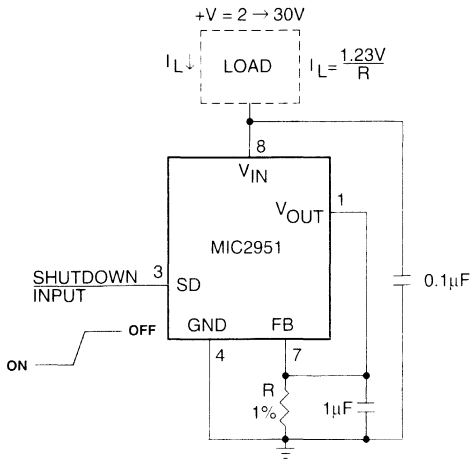

Low Drift Current Source

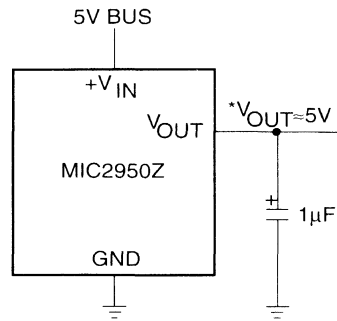

5 Volt Current Limiter

* MINIMUM INPUT-OUTPUT VOLTAGE RANGES FROM 40mV TO 400mV, DEPENDING ON LOAD CURRENT.

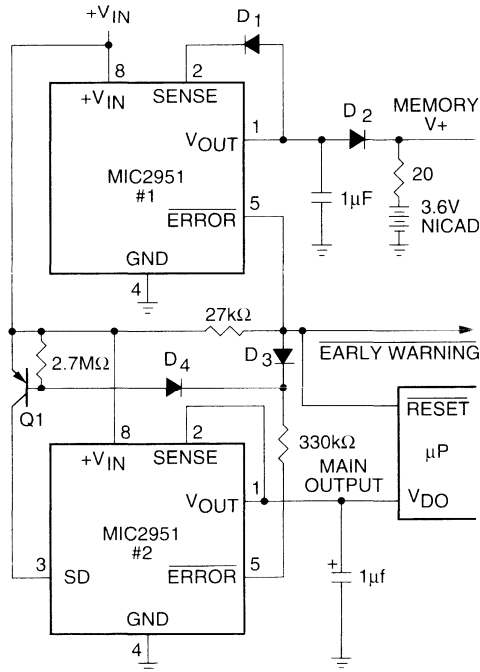

Regulator with Early Warning and Auxiliary Output

- EARLY WARNING FLAG ON LOW INPUT VOLTAGE
- MAIN OUTPUT LATCHES OFF AT LOWER INPUT VOLTAGES
- BATTERY BACKUP ON AUXILIARY OUTPUT

OPERATION: REG. #1'S V_{OUT} IS PROGRAMMED ONE DIODE DROP ABOVE 5 V. ITS ERROR FLAG BECOMES ACTIVE WHEN $V_{IN} < 5.7$ V. WHEN V_{IN} DROPS BELOW 5.3 V, THE ERROR FLAG OF REG. #2 BECOMES ACTIVE AND VIA Q1 LATCHES THE MAIN OUTPUT OFF. WHEN V_{IN} AGAIN EXCEEDS 5.7 V REG. #1 IS BACK IN REGULATION AND THE EARLY WARNING SIGNAL RISES. UNLATCHING REG. #2 VIA D3.

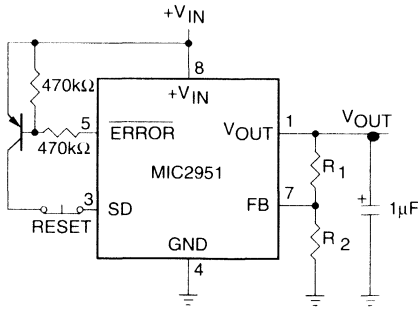

Latch Off When Error Flag Occurs

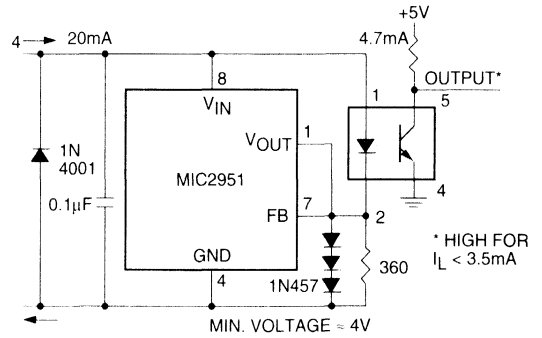

Open Circuit Detector for 4mA to 20mA Current Loop

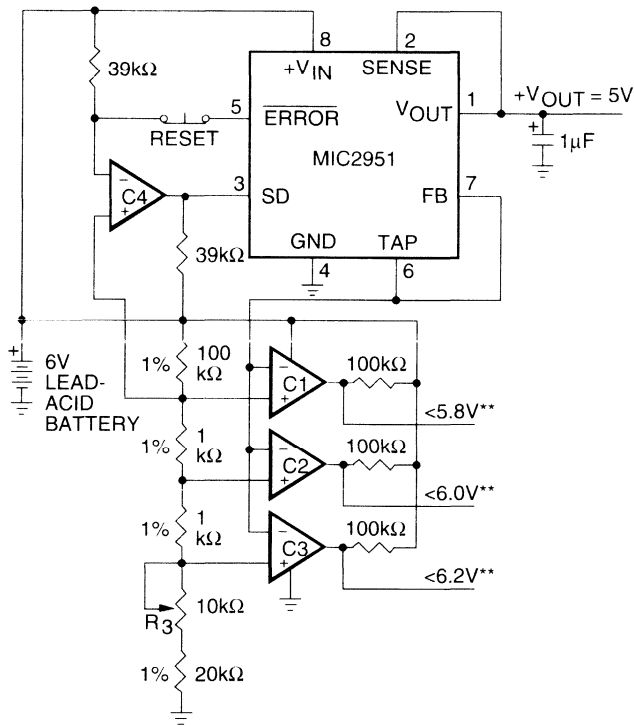

C1 TO C4 ARE COMPARATORS (LP339 OR EQUIVALENT)
 *OPTIONAL LATCH OFF WHEN DROP OUT OCCURS. ADJUST R3 FOR C2 SWITCHING WHEN V_{IN} IS 6.0V
 **OUTPUTS GO LOW WHEN V_{IN} DROPS BELOW DESIGNATED THRESHOLDS.

Regulator with State-of-Charge Indicator

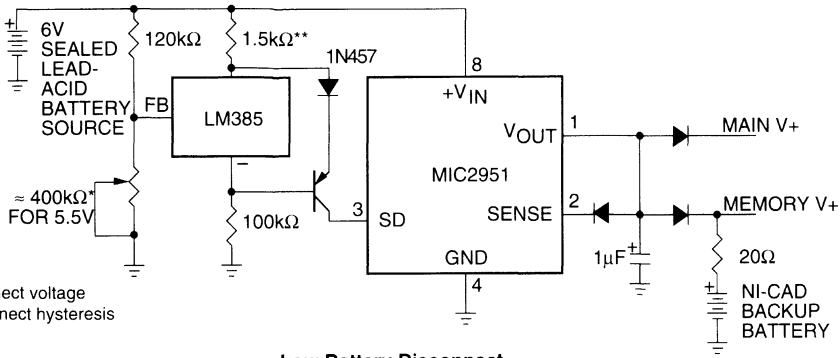

* Sets disconnect voltage
 ** Sets disconnect hysteresis

Low Battery Disconnect

For values shown, Regulator shuts down when $V_{IN} < 5.5$ V and turns on again at 6.0 V. Current drain in disconnected mode is 150μA.

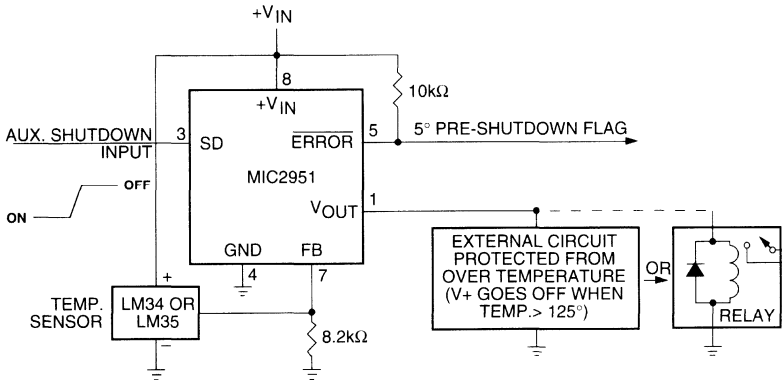

LM34 for 125°F Shutdown
 LM35 for 125°C Shutdown

System Over-Temperature Protection Circuit

Schematic Diagram

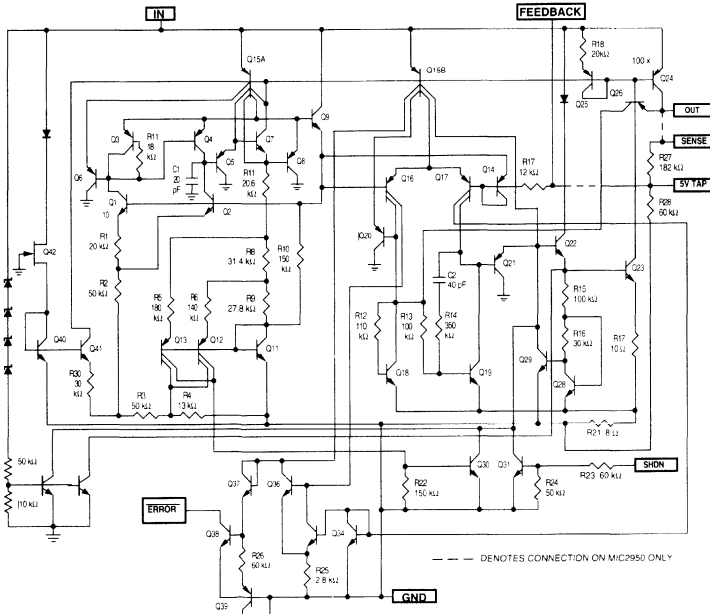

General Description

The MIC5205 is an efficient linear voltage regulator with ultra-low noise output, very low dropout voltage (typically 17mV at light loads and 165mV at 150mA), and very low ground current (600µA at 100mA output). The MIC5205 offers better than 1% initial accuracy.

Designed especially for hand-held, battery-powered devices, the MIC5205 includes a CMOS or TTL compatible enable/shutdown control input. When shutdown, power consumption drops nearly to zero. Regulator ground current increases only slightly in dropout, further prolonging battery life.

Key MIC5205 features include a reference bypass pin to improve its already excellent low-noise performance, reversed-battery protection, current limiting, and overtemperature shutdown.

The MIC5205 is available in fixed and adjustable output voltage versions in a small SOT-23-5 package.

Features

- Ultra low-noise output
- High output voltage accuracy
- Guaranteed 150mA output
- Low quiescent current
- Low dropout voltage
- Extremely tight load and line regulation
- Very low temperature coefficient
- Current and thermal limiting
- Reverse-battery protection
- "Zero" off-mode current
- Logic-controlled electronic enable

Applications

- Cellular telephones
- Laptop, notebook, and palmtop computers
- Battery-powered equipment
- PCMCIA V_{CC} and V_{PP} regulation/switching
- Consumer/personal electronics
- SMPS post-regulator/dc-to-dc modules
- High-efficiency linear power supplies

Ordering Information

Part Number	Marking	Voltage	Accuracy	Junction Temp. Range*	Package
MIC5205BM5	LBAA	Adj	1%	-40°C to +125°C	SOT-23-5
MIC5205-3.0BM5	LB30	3.0	1%	-40°C to +125°C	SOT-23-5
MIC5205-3.3BM5	LB33	3.3	1%	-40°C to +125°C	SOT-23-5
MIC5205-3.6BM5	LB36	3.6	1%	-40°C to +125°C	SOT-23-5
MIC5205-3.8BM5	LB38	3.8	1%	-40°C to +125°C	SOT-23-5
MIC5205-4.0BM5	LB40	4.0	1%	-40°C to +125°C	SOT-23-5
MIC5205-5.0BM5	LB50	5.0	1%	-40°C to +125°C	SOT-23-5

Other voltages available. Contact Micrel for details.

Typical Application

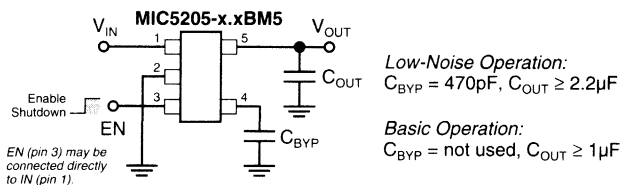

Low-Noise Regulator Application

Pin Configuration

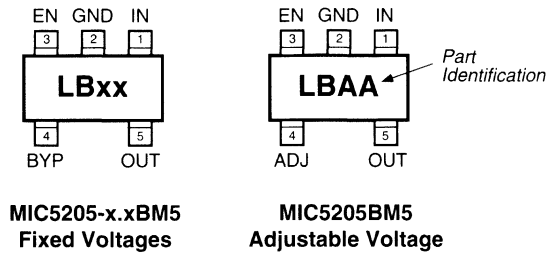

Pin Description

MIC5205-x.x (fixed)	MIC5205 (adjustable)	Pin Name	Pin Function
1	1	IN	Supply Input
2	2	GND	Ground
3	3	EN	Enable/Shutdown (Input): CMOS compatible input. Logic high = enable, logic low or open = shutdown.
4		BYP	Reference Bypass: Connect external 470pF capacitor to GND to reduce output noise. May be left open.
	4	ADJ	Adjust (Input): Adjustable regulator feedback input. Connect to resistor voltage divider.
5	5	OUT	Regulator Output

Absolute Maximum Ratings (Note 1)

Supply Input Voltage (V_{IN})	-20V to +20V
Enable Input Voltage (V_{EN})	-20V to +20V
Power Dissipation (P_D)	Internally Limited
Lead Temperature (soldering, 5 sec.)	260°C
Junction Temperature (T_J)	-40°C to +125°C

Operating Ratings (Note 1)

Input Voltage (V_{IN})	+2.5V to +16V
Enable Input Voltage (V_{EN})	0V to V_{IN}
Junction Temperature (T_J)	-40°C to +125°C
Thermal Resistance, SOT-23-5 (θ_{JA})	Note 1

Electrical Characteristics

$V_{IN} = V_{OUT} + 1V$; $I_L = 100\mu A$; $C_L = 1.0\mu F$; $V_{EN} \geq 2.0V$; $T_J = 25^\circ C$, **bold** values indicate $-40^\circ C \leq T_J \leq +125^\circ C$; unless noted.

Symbol	Parameter	Conditions	Min	Typical	Max	Units
V_O	Output Voltage Accuracy	variation from specified V_{OUT}	-1 -2		1 2	%
$\Delta V_O/\Delta T$	Output Voltage Temperature Coefficient	Note 2		40		ppm/ $^\circ C$
$\Delta V_O/V_O$	Line Regulation	$V_{IN} = V_{OUT} + 1V$ to 16V		0.004	0.012	% / V
$\Delta V_O/V_O$	Load Regulation	$I_L = 0.1mA$ to 150mA (Note 3)		0.02	0.2	%
$V_{IN} - V_O$	Dropout Voltage, Note 4	$I_L = 100\mu A$ $I_L = 50mA$ $I_L = 100mA$ $I_L = 150mA$		10 110 140 165	50 150 250 275	mV
I_{GND}	Quiescent Current	$V_{EN} \leq 0.7V$ (shutdown)		0.01	1	μA
I_{GND}	Ground Pin Current, Note 5	$V_{EN} \geq 2.0V$, $I_L = 100\mu A$ $I_L = 50mA$ $I_L = 100mA$ $I_L = 150mA$		80 350 600 1300	125 600 1000 1900	μA
PSRR	Ripple Rejection	frequency = 100Hz, $I_L = 100\mu A$		75	500	dB
I_{LIMIT}	Current Limit	$V_{OUT} = 0V$		320		mA
$\Delta V_O/\Delta P_D$	Thermal Regulation	Note 6		0.05		%/W
e_{no}	Output Noise	$I_L = 50mA$, $C_L = 2.2\mu F$, 470pF from BYP to GND		260		nV \sqrt{Hz}

ENABLE Input

V_{IL}	Enable Input Voltage Level Logic Low Logic High	regulator shutdown regulator enabled	2.0		0.4 0.18	V
I_{IL} I_{IH}	Enable Input Current	$V_{IL} \leq 0.4V$; $V_{IL} < \mathbf{0.18V}$ $V_{IH} \geq 2.0V$		0.01 5	-1 10	μA

Note 1: Absolute maximum ratings indicate limits beyond which damage to the component may occur. Electrical specifications do not apply when operating the device outside of its operating ratings. The maximum allowable power dissipation is a function of the maximum junction temperature, $T_{J(max)}$, the junction-to-ambient thermal resistance, θ_{JA} , and the ambient temperature, T_A . The maximum allowable power dissipation at any ambient temperature is calculated using: $P_{D(max)} = (T_{J(max)} - T_A) \theta_{JA}$. Exceeding the maximum allowable power dissipation will result in excessive die temperature, and the regulator will go into thermal shutdown. The θ_{JA} of the MIC5205-xxBM5 (all versions) is 220 $^\circ C/W$ mounted on a PC board (see "Thermal Considerations" section for further details).

Note 2: Output voltage temperature coefficient is defined as the worst case voltage change divided by the total temperature range.

Note 3: Regulation is measured at constant junction temperature using low duty cycle pulse testing. Parts are tested for load regulation in the load range from 0.1mA to 150mA. Changes in output voltage due to heating effects are covered by the thermal regulation specification.

Note 4: Dropout Voltage is defined as the input to output differential at which the output voltage drops 2% below its nominal value measured at 1V differential.

Note 5: Ground pin current is the regulator quiescent current plus pass transistor base current. The total current drawn from the supply is the sum of the load current plus the ground pin current.

Note 6: Thermal regulation is defined as the change in output voltage at a time "t" after a change in power dissipation is applied, excluding load or line regulation effects. Specifications are for a 150mA load pulse at $V_{IN} = 16V$ for $t = 10ms$.

Typical Characteristics

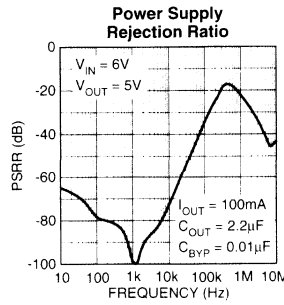
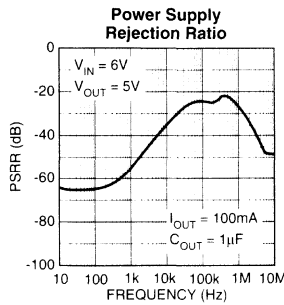
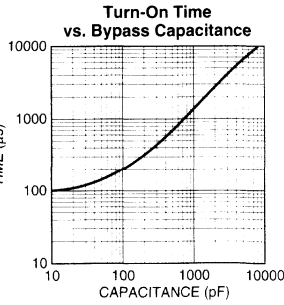
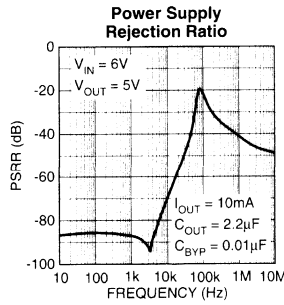
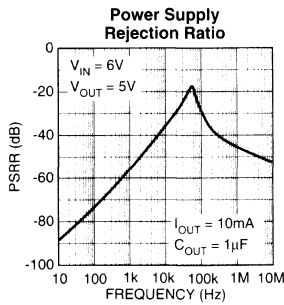
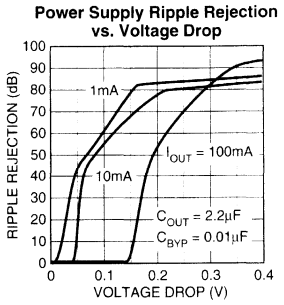
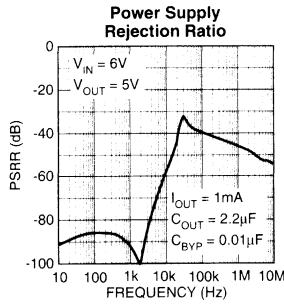
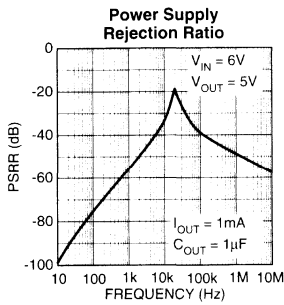
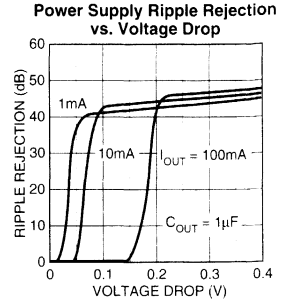
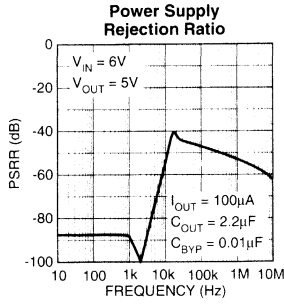
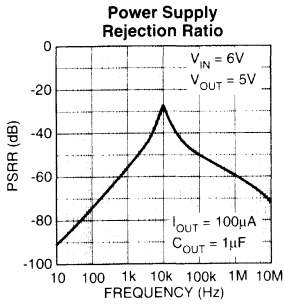

Typical Characteristics

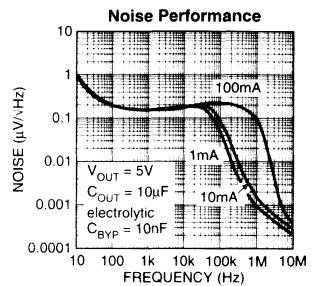
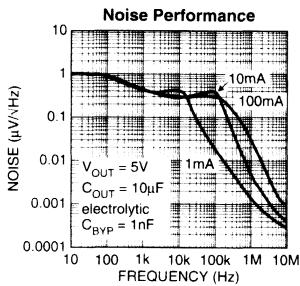
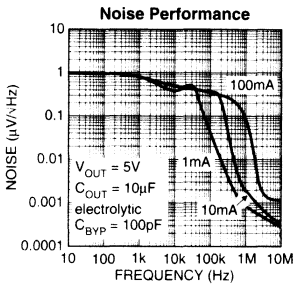
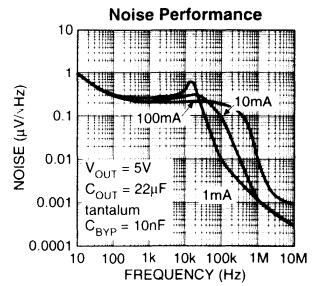
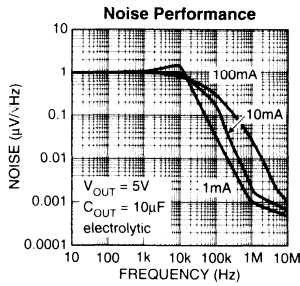
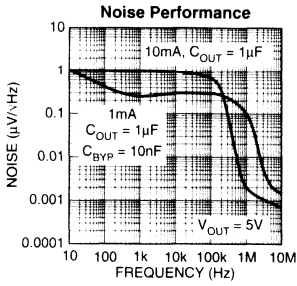

Applications Information

Enable/Shutdown

Forcing EN (enable/shutdown) high (> 2V) enables the regulator. EN is compatible with CMOS logic gates.

If the enable/shutdown feature is not required, connect EN (pin 3) to IN (supply input, pin 1). See Figure 1.

Input Capacitor

A 1 μ F capacitor should be placed from IN to GND if there is more than 10 inches of wire between the input and the ac filter capacitor or if a battery is used as the input.

Reference Bypass Capacitor

BYP (reference bypass) is connected to the internal voltage reference. A 470pF capacitor (C_{BYP}) connected from BYP to GND quiets this reference, providing a significant reduction in output noise. C_{BYP} reduces the regulator phase margin; when using C_{BYP} , output capacitors of 2.2 μ F or greater are generally required to maintain stability.

The start-up speed of the MIC5205 is inversely proportional to the size of the reference bypass capacitor. Applications requiring a slow ramp-up of output voltage should consider larger values of C_{BYP} . Likewise, if rapid turn-on is necessary, consider omitting C_{BYP} .

If output noise is not a major concern, omit C_{BYP} and leave BYP open.

Output Capacitor

An output capacitor is required between OUT and GND to prevent oscillation. The minimum size of the output capacitor is dependent upon whether a reference bypass capacitor is used. 1.0 μ F minimum is recommended when C_{BYP} is not used (see Figure 2). 2.2 μ F minimum is recommended when C_{BYP} is 470 μ F (see Figure 1). Larger values improve the regulator's transient response. The output capacitor value may be increased without limit.

The output capacitor should have an ESR (effective series resistance) of about 5 Ω or less and a resonant frequency above 1MHz. Most tantalum or aluminum electrolytic capacitors are adequate; film types will work, but are more expensive. Since many aluminum electrolytics have electrolytes that freeze at about -30 $^{\circ}$ C, solid tantalums are recommended for operation below -25 $^{\circ}$ C.

At lower values of output current, less output capacitance is required for output stability. The capacitor can be reduced to 0.47 μ F for current below 10mA or 0.33 μ F for currents below 1mA.

No-Load Stability

The MIC5205 will remain stable and in regulation with no load (other than the internal voltage divider) unlike many other voltage regulators. This is especially important in CMOS RAM keep-alive applications.

Fixed Regulator Applications

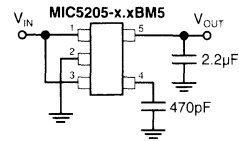

Figure 1. Low-Noise Fixed Voltage Application

Figure 1 includes a 470 μ F capacitor for low-noise operation and shows EN (pin 3) connected to IN (pin 1) for an application where enable/shutdown is not required. $C_{OUT} = 2.2\mu$ F minimum.

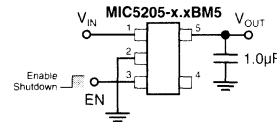

Figure 2. Basic Fixed Voltage Application

Figure 2 is an example of a basic configuration where the lowest-noise operation is not required. $C_{OUT} = 1\mu$ F minimum.

Adjustable Regulator Applications

Figure 3 shows the MIC5205BM5 adjustable output voltage configuration. Two resistors set the output voltage. The formula for output voltage is:

$$V_{OUT} = 1.242V \times \left(\frac{R2}{R1} + 1 \right)$$

Resistor values are not critical because ADJ (adjust) has a high input impedance, but for best results use resistors of 470k Ω or less. A capacitor from ADJ to ground provides greatly improved noise performance.

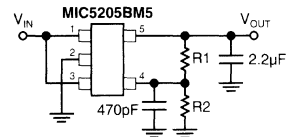

Figure 3. Low-Noise Adjustable Voltage Application

Figure 3 includes the optional 470pF noise bypass capacitor from ADJ to GND to reduce output noise.

Dual-Supply Operation

When used in dual supply systems where the regulator load is returned to a negative supply, the output voltage must be diode clamped to ground.

Thermal Considerations

Layout

The MIC5205-xxBM5 (5-lead SOT-23 package) has the following thermal characteristics when mounted on a single layer copper-clad printed circuit board.

PC Board Dielectric	θ_{JA}
FR4	220°C/W
Ceramic	200°C/W

Multilayer boards having a ground plane, wide traces near the pads, and large supply bus lines provide better thermal conductivity.

The “worst case” value of 220°C/W assumes no ground plane, minimum trace widths, and a FR4 material board.

Nominal Power Dissipation and Die Temperature

The MIC5205-xxBM5 at a 25°C ambient temperature will operate reliably at over 450mW power dissipation when mounted in the “worst case” manner described above. At an ambient temperature of 40°C, the device may safely dissipate over 380mW. These power levels are equivalent to a die temperature of 125°C, the maximum operating junction temperature for the MIC5205.

For additional heat sink characteristics, please refer to Micrel Application Hint 17, “Calculating P.C. Board Heat Sink Area For Surface Mount Packages”.

General Description

The MIC5206 is an efficient linear voltage regulator with very low dropout voltage (typically 17mV at light loads and 165mV at 150mA), and very low ground current (600 μ A at 100mA output), with better than 1% initial accuracy. It has a logic compatible enable/shutdown control input and an internal undervoltage monitor.

Designed especially for hand-held, battery-powered devices, the MIC5206 can be switched by a CMOS or TTL compatible logic signal. When disabled, power consumption drops nearly to zero. Dropout ground current is minimized to prolong battery life.

Key features include an undervoltage monitor with an error flag output, a reference bypass pin to improve its already low-noise performance (8-lead versions only), reversed-battery protection, current limiting, and overtemperature shutdown.

The MIC5206 is available in several fixed voltages in a tiny SOT-23-5 package. It features a pinout, similar to the LP2980, but has significantly better performance. Fixed and adjustable output voltage versions, featuring the reference bypass option, are available in the 8-lead Micrel Mini8™ MSOP (micro small-outline package).

Features

- Error flag indicates undervoltage fault
- High output voltage accuracy
- Guaranteed 150mA output
- Ultra low-noise output (8-lead versions)
- Low quiescent current
- Low dropout voltage
- Extremely tight load and line regulation
- Very low temperature coefficient
- Current and thermal limiting
- Reversed-battery protection
- "Zero" off-mode current
- Logic-controlled electronic enable

Applications

- Cellular telephones
- Laptop, notebook, and palmtop computers
- Battery-powered equipment
- PCMCIA V_{CC} and V_{PP} regulation/switching
- Consumer/personal electronics
- SMPS post-regulator/dc-to-dc modules
- High-efficiency linear power supplies

Typical Applications

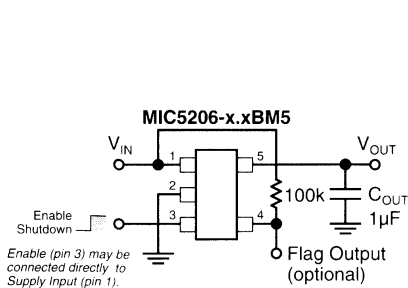

SOT-23-5 Fixed Voltage Application

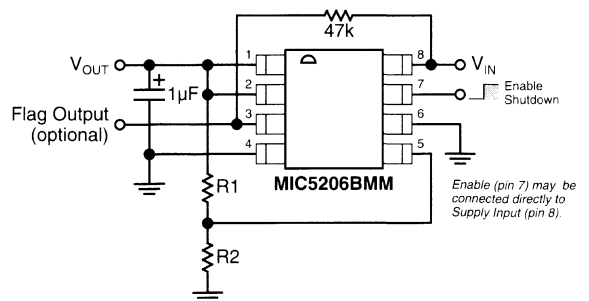

Micrel Mini8™ Adjustable Voltage Application

Ordering Information

Part Number	Marking	Volts	Accuracy	Temperature Range*	Package
MIC5206-3.0BM5	LD30	3.0	1%	-40°C to +125°C	SOT-23-5
MIC5206-3.3BM5	LD33	3.3	1%	-40°C to +125°C	SOT-23-5
MIC5206-3.6BM5	LD36	3.6	1%	-40°C to +125°C	SOT-23-5
MIC5206-3.8BM5	LD38	3.8	1%	-40°C to +125°C	SOT-23-5
MIC5206-4.0BM5	LD40	4.0	1%	-40°C to +125°C	SOT-23-5
MIC5206-5.0BM5	LD50	5.0	1%	-40°C to +125°C	SOT-23-5
MIC5206BMM	—	Adj	1%	-40°C to +125°C	8-lead MSOP
MIC5206-3.0BMM	—	3.0	1%	-40°C to +125°C	8-lead MSOP
MIC5206-3.3BMM	—	3.3	1%	-40°C to +125°C	8-lead MSOP
MIC5206-3.6BMM	—	3.6	1%	-40°C to +125°C	8-lead MSOP
MIC5206-3.8BMM	—	3.8	1%	-40°C to +125°C	8-lead MSOP
MIC5206-4.0BMM	—	4.0	1%	-40°C to +125°C	8-lead MSOP
MIC5206-5.0BMM	—	5.0	1%	-40°C to +125°C	8-lead MSOP

Other voltages available. Contact Micrel for details.

Pin Configuration

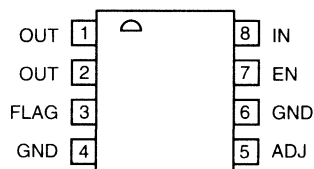
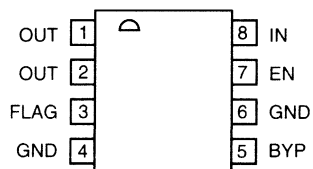
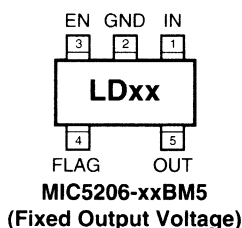

Pin Description

MIC5206 M5	MIC5206 MM	Pin Name	Pin Function
1	1	IN	Supply Input
2	2	GND	Ground
3	3	EN	Enable/Shutdown (Input): CMOS compatible input. Logic high = enable, logic low or open = shutdown. Do not leave floating.
4	3	FLAG	Error Flag (Output): Open-collector output. Active low indicates an output undervoltage condition.
	5 (fixed)	BYP	Reference Bypass: Connect external 470pF capacitor to GND to reduce output noise. May be left open.
	5 (adj.)	ADJ	Adjust (Input): Adjustable regulator feedback input. Connect to resistor voltage divider.
5	1,2	OUT	Regulator Output

Absolute Maximum Ratings

Supply Input Voltage (V_{IN}) -20V to +20V
Enable Input Voltage (V_{EN}) -20V to +20V
Power Dissipation (P_D) Internally Limited
Junction Temperature (T_J) -40°C to +125°C
Lead Temperature (Soldering, 5 sec.) 260°C

Operating Ratings

Supply Input Voltage (V_{IN}) +2.5V to +16V
Enable Input Voltage (V_{EN}) 0V to V_{IN}
Junction Temperature (T_J) -40°C to +125°C
SOT-23-5 (θ_{JA}) Note 1
8-lead MSOP SOIC (θ_{JA}) Note 1

Electrical Characteristics

$V_{IN} = V_{OUT} + 1V$; $I_L = 100\mu A$; $C_L = 1.0\mu F$; $V_{EN} \geq 2.0V$; $T_J = 25^\circ C$, **bold** values indicate $-40^\circ C \leq T_J \leq +125^\circ C$; unless noted.

Symbol	Parameter	Conditions	Min	Typical	Max	Units
V_O	Output Voltage Accuracy	variation from nominal V_{OUT}	-1 -2		1 2	% %
$\Delta V_O / \Delta T$	Output Voltage Temperature Coefficient	Note 2		40		ppm/°C
$\Delta V_O / V_O$	Line Regulation	$V_{IN} = V_{OUT} + 1V$ to 16V		0.004	0.012	% / V
$\Delta V_O / I_O$	Load Regulation	$I_L = 0.1mA$ to 150mA Note 3		0.02	0.2	%
$V_{IN} - V_O$	Dropout Voltage, Note 4	$I_L = 100\mu A$ $I_L = 50mA$ $I_L = 100mA$ $I_L = 150mA$		17 110 140 165	50 150 250 275	mV mV mV mV
I_{GND}	Quiescent Current	$V_{EN} \leq 0.7V$ (shutdown)		0.01	1	μA
I_{GND}	Ground Pin Current, Note 5	$V_{EN} \geq 2.0V$, $I_L = 100\mu A$ $I_L = 50mA$ $I_L = 100mA$ $I_L = 150mA$		80 350 600 1300	125 600 1000 1,900	μA μA μA μA
PSRR	Ripple Rejection			75		dB
I_{LIMIT}	Current Limit	$V_{OUT} = 0V$		320	500	mA
$\Delta V_O / \Delta P_D$	Thermal Regulation	Note 6		0.05		%/W
e_{no}	Output Noise	$I_L = 50mA$, $C_L = 4.7\mu F$, 470pF from BYP to GND (MM package only)		260		nV \sqrt{Hz}

Enable Input

V_{IL}	Input Voltage Level Logic Low Logic High	shutdown enabled	2.0		0.4 0.18	V V
I_{IL} I_{IH}	Enable Input Current	$V_{IL} \leq 0.4V$; $V_{IL} \leq \mathbf{0.18V}$ $V_{IH} \geq 2.0V$		0.01 5	-1 10	μA μA

Error Flag Output

V_{ERR}	Flag Threshold	undervoltage condition (below nominal)		-5	-8	%
V_{IL}	Output Voltage Level Logic Low	$I_L = 1mA$ undervoltage condition		0.2	0.4	V
I_{FL}	Flag Leakage Current	flag off, $V_{FLAG} = 0V$ to 16V	-1	0.1	+1	μA

- Note 1:** Absolute maximum ratings indicate limits beyond which damage to the component may occur. Electrical specifications do not apply when operating the device outside of its operating ratings. The maximum allowable power dissipation is a function of the maximum junction temperature, $T_{J(max)}$, the junction-to-ambient thermal resistance, θ_{JA} , and the ambient temperature, T_A . The maximum allowable power dissipation at any ambient temperature is calculated using: $P_{D(max)} = (T_{J(max)} - T_A) \theta_{JA}$. Exceeding the maximum allowable power dissipation will result in excessive die temperature, and the regulator will go into thermal shutdown. The θ_{JA} of the MIC5206-x.xBM5 (all versions) is 220°C/W mounted on a PC board. The θ_{JA} of the MIC5206-x.xMM (all versions) is 200°C/W mounted on a PC board (see "Thermal Considerations" section for further details).
- Note 2:** Output voltage temperature coefficient is defined as the worst case voltage change divided by the total temperature range.
- Note 3:** Regulation is measured at constant junction temperature using low duty cycle pulse testing. Parts are tested for load regulation in the load range from 0.1mA to 150mA. Changes in output voltage due to heating effects are covered by the thermal regulation specification.
- Note 4:** Dropout Voltage is defined as the input to output differential at which the output voltage drops 2% below its nominal value measured at 1V differential.
- Note 5:** Ground pin current is the regulator quiescent current plus pass transistor base current. The total current drawn from the supply is the sum of the load current plus the ground pin current.
- Note 6:** Thermal regulation is defined as the change in output voltage at a time "t" after a change in power dissipation is applied, excluding load or line regulation effects. Specifications are for a 150mA load pulse at $V_{IN} = 16V$ for $t = 10ms$.

Typical Characteristics

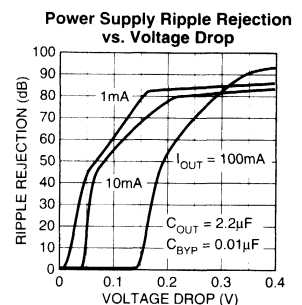
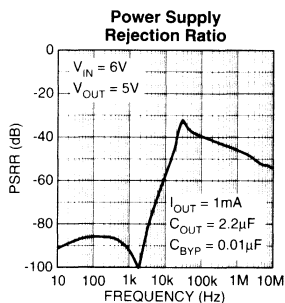
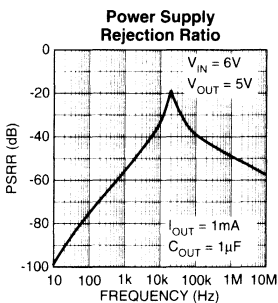
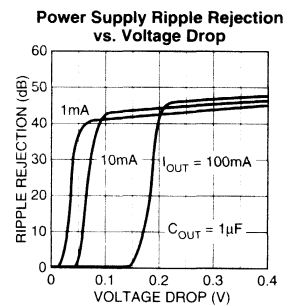
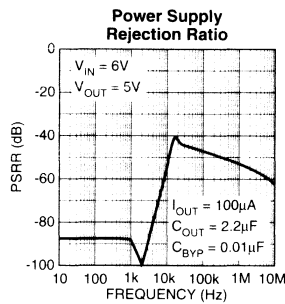
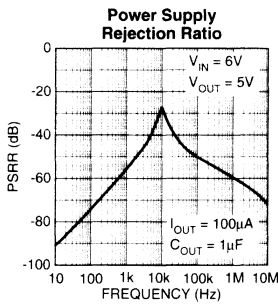

Typical Characteristics

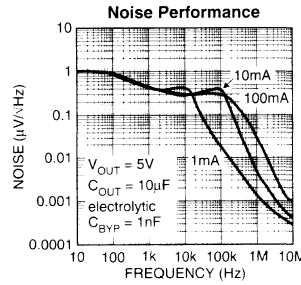
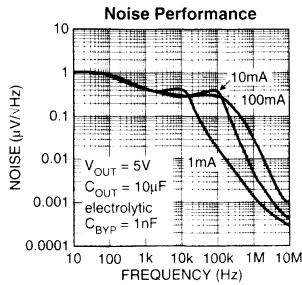
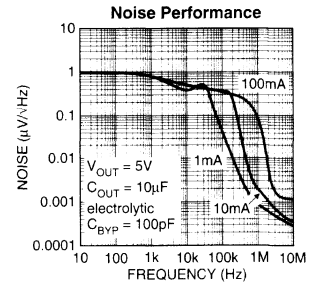
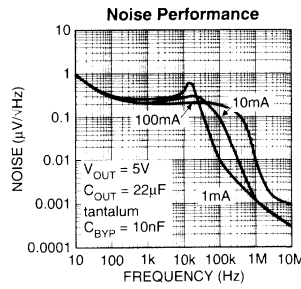
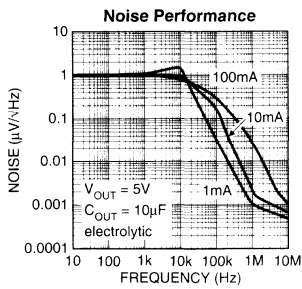
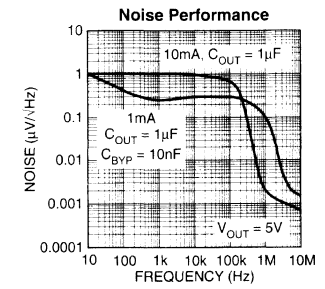
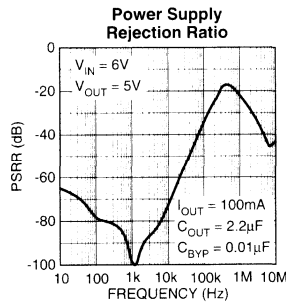
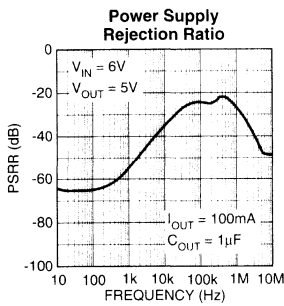
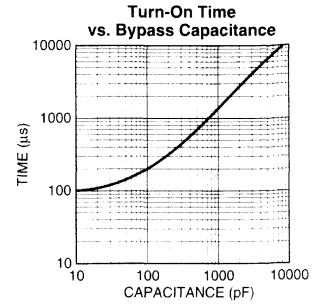
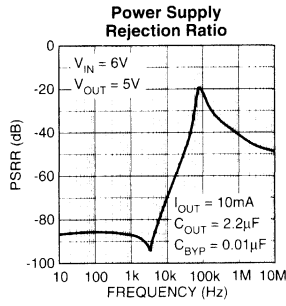
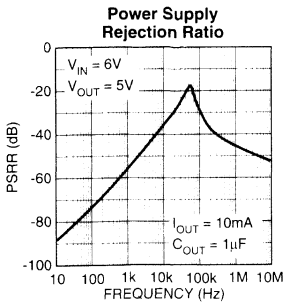

Applications Information

Enable/Shutdown

Forcing EN (enable/shutdown) high (> 2V) enables the regulator. EN is compatible with CMOS logic gates.

If the enable/shutdown feature is not required, connect EN (enable) to IN (supply input). Refer to the text with Figures 1a and 2.

Input Capacitor

A 1 μF capacitor should be placed from IN to GND if there is more than 10 inches of wire between the input and the ac filter capacitor or if a battery is used as the input.

Reference Bypass Capacitor

BYP (reference bypass) is connected to the internal voltage reference. A 470pF capacitor (C_{BYP}) connected from BYP to GND quiets this reference, providing a significant reduction in output noise. See Figure 2. C_{BYP} reduces the regulator phase margin; when using C_{BYP} , output capacitors of 2.2 μF or greater are generally required to maintain stability.

The start-up speed of the MIC5206 is inversely proportional to the size of the reference bypass capacitor. Applications requiring a slow ramp-up of output voltage should consider larger values of C_{BYP} . Likewise, if rapid turn-on is necessary, consider omitting C_{BYP} .

If output noise is not a major concern, omit C_{BYP} and leave BYP open.

Output Capacitor

An output capacitor is required between OUT and GND to prevent oscillation. The minimum size of the output capacitor is dependent upon whether a reference bypass capacitor is used. 1.0 μF minimum is recommended when C_{BYP} is not used (see Figure 2). 2.2 μF minimum is recommended when C_{BYP} is 470 μF (see Figure 2). Larger values improve the regulator's transient response. The output capacitor value may be increased without limit.

The output capacitor should have an ESR (effective series resistance) of about 5 Ω or less and a resonant frequency above 1MHz. Most tantalum or aluminum electrolytic capacitors are adequate; film types will work, but are more expensive. Since many aluminum electrolytics have electrolytes that freeze at about -30°C , solid tantalums are recommended for operation below -25°C .

At lower values of output current, less output capacitance is required for output stability. The capacitor can be reduced to 0.47 μF for current below 10mA or 0.33 μF for currents below 1mA.

No-Load Stability

The MIC5205 will remain stable and in regulation with no load (other than the internal voltage divider) unlike many other voltage regulators. This is especially important in CMOS RAM keep-alive applications.

Error Flag Output

The error flag is an open-collector output and is active (low) when an undervoltage of approximately 5% below the nomi-

nal output voltage is detected. A pullup resistor from IN to FLAG is shown in all schematics.

If an error indication is not required, FLAG may be left open and the pullup resistor may be omitted.

Fixed Regulator Applications

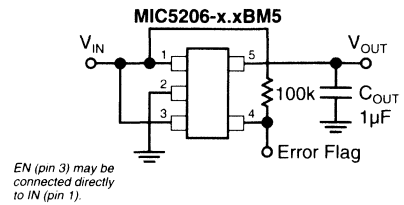

Figure 1a. Basic Fixed Voltage Application

EN (pin 3) is shown connected to IN (pin 1) for an application where enable/shutdown is not required. The error flag is shown with a 100k Ω pullup resistor.

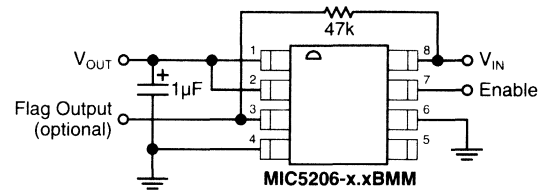

Figure 1b. Basic Fixed Voltage Application

Figure 1b is an example of a basic configuration where the lowest-noise operation is not required. $C_{\text{OUT}} = 1 \mu\text{F}$ minimum. The error flag is shown with a 47k Ω pullup resistor.

Low-Noise Application

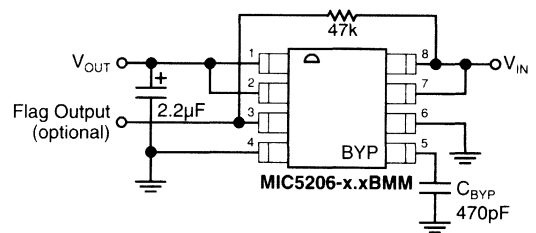

Figure 2. Low-Noise Fixed Voltage Application

Figure 2 includes a 470 μF capacitor for low-noise operation and shows EN (pin 7) connected to IN (pin 8) for an application where enable/shutdown is not required. The error flag is shown with a 47k Ω pullup resistor.

Adjustable Regulator Applications

Figure 3 shows the MIC5206BMM adjustable output voltage configuration. Two resistors set the output voltage. The formula for output voltage is:

$$V_{\text{OUT}} = 1.242\text{V} \times \left(\frac{R_2}{R_1} + 1 \right)$$

Resistor values are not critical because ADJ (adjust) has a high input impedance, but for best results use resistors of 470k Ω or less. A capacitor from ADJ to ground provides greatly improved noise performance.

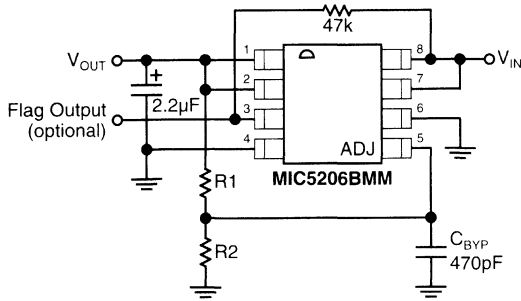

Figure 3. Low-Noise Adjustable Voltage Application

Figure 3 also includes a 470 μ F capacitor for low-noise operation and shows EN (pin 7) connected to IN (pin 8) for an application where enable/shutdown is not required. C_{OUT} = 2.2 μ F minimum. The error flag is shown with a 47k Ω pullup resistor.

Thermal Considerations

Layout

The MIC5206-x.xBM5 (5-lead SOT-23 package) has the following thermal characteristics when mounted on a single

layer copper-clad printed circuit board.

Multilayer boards having a ground plane, wide traces near the pads, and large supply bus lines provide better thermal conductivity.

PC Board Dielectric	θ_{JA}
FR4	220°C/W
Ceramic	200°C/W

SOT-23-5 Thermal Characteristics

The “worst case” value of 220°C/W assumes no ground plane, minimum trace widths, and a FR4 material board.

The MIC5206-xxBMM (8-lead MSOP) has a thermal resistance of 200°C/W when mounted on a FR4 board with minimum trace widths and no ground plane.

PC Board Dielectric	θ_{JA}
FR4	200°C

MSOP Thermal Characteristics

Nominal Power Dissipation and Die Temperature

The MIC5206-x.xBM5 at a 25°C ambient temperature will operate reliably at over 450mW power dissipation when mounted in the “worst case” manner described above. At an ambient temperature of 40°C, the device may safely dissipate over 380mW. These power levels are equivalent to a die temperature of 125°C, the maximum operating junction temperature for the MIC5206.

For additional heat sink characteristics, please refer to Micrel Application Hint 17, “Calculating P.C. Board Heat Sink Area For Surface Mount Packages”.

General Description

The MIC5207 is an efficient linear voltage regulator with ultra low-noise output, very low dropout voltage (typically 17mV at light loads and 165mV at 180mA), and very low ground current (720 μ A at 100mA output). The MIC5207 offers better than 3% initial accuracy.

Designed especially for hand-held, battery-powered devices, the MIC5207 includes a CMOS or TTL compatible enable/shutdown control input. When shutdown, power consumption drops nearly to zero.

Key MIC5207 features include a reference bypass pin to improve its already low-noise performance, reversed-battery protection, current limiting, and overtemperature shutdown.

The MIC5205 is available in fixed and adjustable output voltage versions in a small SOT-23-5 package.

Features

- Ultra low-noise output
- High output voltage accuracy
- Guaranteed 180mA output
- Low quiescent current
- Low dropout voltage
- Extremely tight load and line regulation
- Very low temperature coefficient
- Current and thermal limiting
- Reverse-battery protection
- "Zero" off-mode current
- Logic-controlled electronic enable

Applications

- Cellular telephones
- Laptop, notebook, and palmtop computers
- Battery-powered equipment
- PCMCIA V_{CC} and V_{PP} regulation/switching
- Consumer/personal electronics
- SMPS post-regulator/dc-to-dc modules
- High-efficiency linear power supplies

Ordering Information

Part Number	Marking	Voltage	Accuracy	Junction Temp. Range*	Package
MIC5207BM5	LEAA	Adj	3%	-40°C to +125°C	SOT-23-5
MIC5207-3.0BM5	LE30	3.0	3%	-40°C to +125°C	SOT-23-5
MIC5207-3.3BM5	LE33	3.3	3%	-40°C to +125°C	SOT-23-5
MIC5207-3.6BM5	LE36	3.6	3%	-40°C to +125°C	SOT-23-5
MIC5207-3.8BM5	LE38	3.8	3%	-40°C to +125°C	SOT-23-5
MIC5207-4.0BM5	LE40	4.0	3%	-40°C to +125°C	SOT-23-5
MIC5207-5.0BM5	LE50	5.0	3%	-40°C to +125°C	SOT-23-5

Other voltages available. Contact Micrel for details.

Typical Application

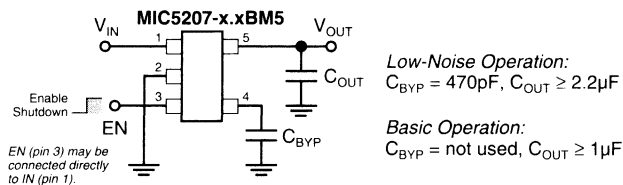

Battery-Powered Regulator Application

Pin Configuration

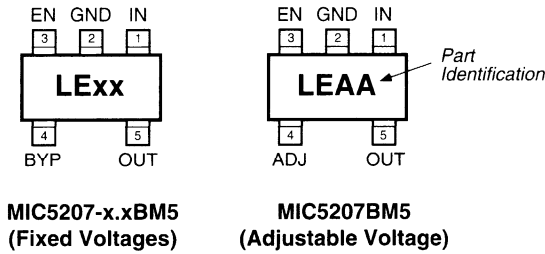

Pin Description

MIC5207-x.x (fixed)	MIC5207 (adjustable)	Pin Name	Pin Function
1	1	IN	Supply Input
2	2	GND	Ground
3	3	EN	Enable/Shutdown (Input): CMOS compatible input. Logic high = enable, logic low or oopen = shutdown.
4		BYP	Reference Bypass: Connect external 470pF capacitor to GND to reduce output noise. May be left open.
	4	ADJ	Adjust (Input): Adjustable regulator feedback input. Connect to resistor voltage divider.
5	5	OUT	Regulator Output

Absolute Maximum Ratings (Note 1)

Supply Input Voltage (V_{IN})	-20V to +20V
Enable Input Voltage (V_{EN})	-20V to +20V
Power Dissipation (P_D)	Internally Limited
Lead Temperature (soldering, 5 sec.)	260°C
Junction Temperature (T_J)	-40°C to +125°C

Operating Ratings (Note 1)

Input Voltage (V_{IN})	+2.5V to +16V
Enable Input Voltage (V_{EN})	0V to V_{IN}
Junction Temperature (T_J)	-40°C to +125°C
Thermal Resistance, SOT-23-5 (θ_{JA})	Note 1

Electrical Characteristics

$V_{IN} = V_{OUT} + 1V$; $I_L = 100\mu A$; $C_L = 1.0\mu F$; $V_{EN} \geq 2.0V$; $T_J = 25^\circ C$, **bold** values indicate $-40^\circ C \leq T_J \leq +125^\circ C$; unless noted.

Symbol	Parameter	Conditions	Min	Typical	Max	Units
V_O	Output Voltage Accuracy	variation from specified V_{OUT}	-3 -4		3 4	%
$\Delta V_O/\Delta T$	Output Voltage Temperature Coef.	Note 2		40		ppm/ $^\circ C$
$\Delta V_O/V_O$	Line Regulation	$V_{IN} = V_{OUT} + 1V$ to 16V		0.005	0.05	%/V
$\Delta V_O/V_O$	Load Regulation	$I_L = 0.1mA$ to 150mA (Note 3)		0.05	0.5	%
$V_{IN} - V_O$	Dropout Voltage, Note 4	$I_L = 100\mu A$ $I_L = 50mA$ $I_L = 100mA$ $I_L = 150mA$		17 115 140	60 175 300	mV
I_{GND}	Quiescent Current	$V_{EN} \leq 0.7V$ (shutdown)		0.01	1	μA
I_{GND}	Ground Pin Current, Note 5	$V_{EN} \geq 2.0V$, $I_L = 100\mu A$ $I_L = 50mA$ $I_L = 100mA$ $I_L = 150mA$		80 350 720 1800	130 650 1100 2500	μA
PSRR	Ripple Rejection			75		dB
I_{LIMIT}	Current Limit	$V_{OUT} = 0V$		320	500	mA
$\Delta V_O/\Delta P_D$	Thermal Regulation	Note 6		0.05		%/W
e_{no}	Output Noise	$I_L = 50mA$, $C_L = 2.2\mu F$, 470pF from BYP to GND		260		nV \sqrt{Hz}

ENABLE Input

V_{IL}	Enable Input Voltage Level Logic Low Logic High	regulator shutdown regulator enabled	2.0		0.4 0.18	V
I_{IL} I_{IH}	Enable Input Current	$V_{IL} \leq 0.4V$; $V_{IL} \leq \mathbf{0.18V}$ $V_{IH} \geq 2.0V$		0.01 5	-1 10	μA

Note 1: Absolute maximum ratings indicate limits beyond which damage to the component may occur. Electrical specifications do not apply when operating the device outside of its operating ratings. The maximum allowable power dissipation is a function of the maximum junction temperature, $T_{J(max)}$, the junction-to-ambient thermal resistance, θ_{JA} , and the ambient temperature, T_A . The maximum allowable power dissipation at any ambient temperature is calculated using: $P_{D(max)} = (T_{J(max)} - T_A) \theta_{JA}$. Exceeding the maximum allowable power dissipation will result in excessive die temperature, and the regulator will go into thermal shutdown. The θ_{JA} of the MIC5207-xxBM5 (all versions) is 220 $^\circ C/W$ mounted on a PC board (see "Thermal Considerations" section for further details).

Note 2: Output voltage temperature coefficient is defined as the worst case voltage change divided by the total temperature range.

Note 3: Regulation is measured at constant junction temperature using low duty cycle pulse testing. Parts are tested for load regulation in the load range from 0.1mA to 180mA. Changes in output voltage due to heating effects are covered by the thermal regulation specification.

Note 4: Dropout voltage is defined as the input to output differential at which the output voltage drops 2% below its nominal value measured at 1V differential.

Note 5: Ground pin current is the regulator quiescent current plus pass transistor base current. The total current drawn from the supply is the sum of the load current plus the ground pin current.

Note 6: Thermal regulation is defined as the change in output voltage at a time "t" after a change in power dissipation is applied, excluding load or line regulation effects. Specifications are for a 180mA load pulse at $V_{IN} = 16V$ for $t = 10ms$.

Typical Characteristics

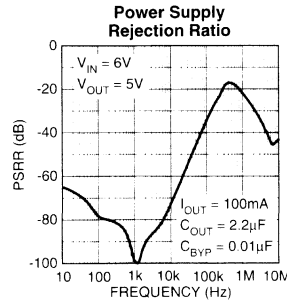
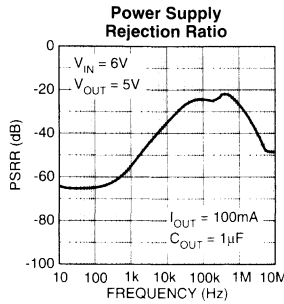
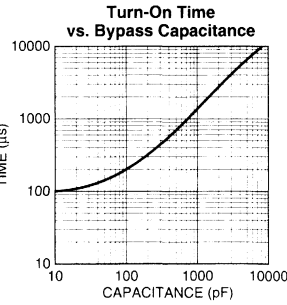
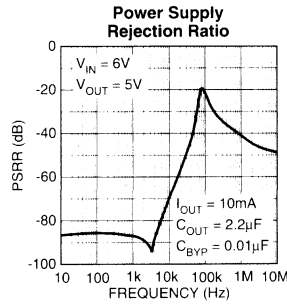
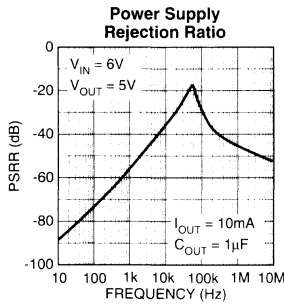
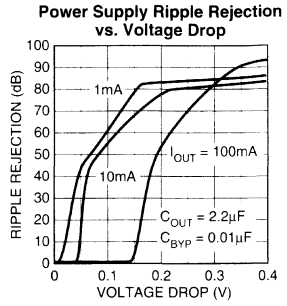
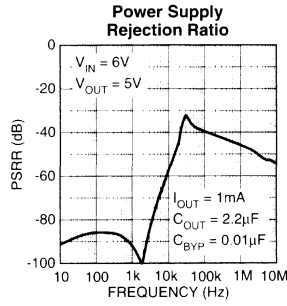
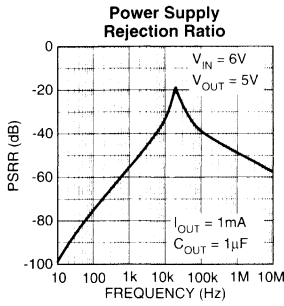
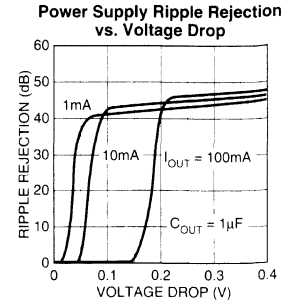
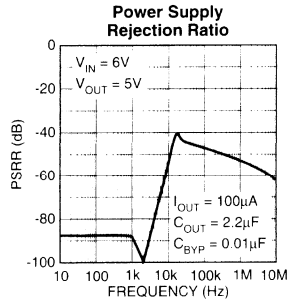
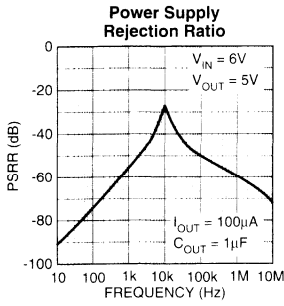

Typical Characteristics

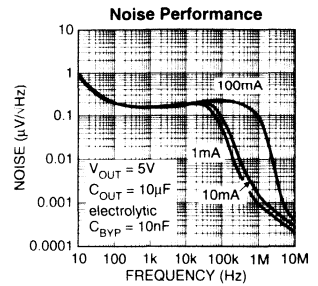
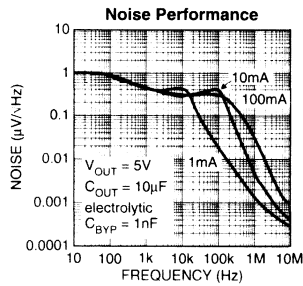
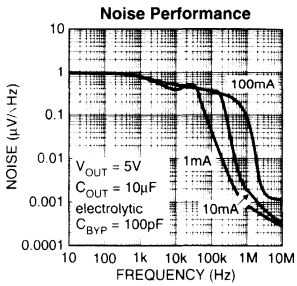
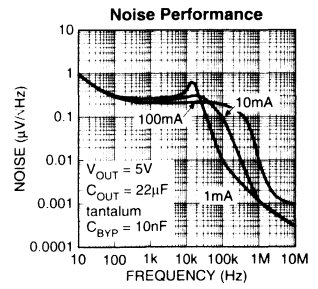
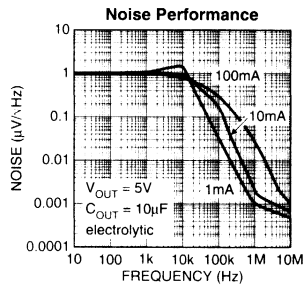
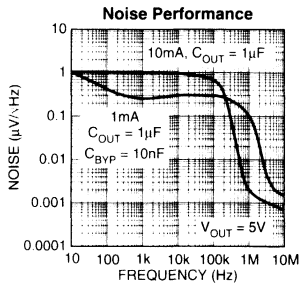

Applications Information

Enable/Shutdown

Forcing EN (enable/shutdown) high (> 2V) enables the regulator. EN is compatible with CMOS logic gates.

If the enable/shutdown feature is not required, connect EN (pin 3) to IN (supply input, pin 1). See Figure 1.

Input Capacitor

A 1 μ F capacitor should be placed from IN to GND if there is more than 10 inches of wire between the input and the ac filter capacitor or if a battery is used as the input.

Reference Bypass Capacitor

BYP (reference bypass) is connected to the internal voltage reference. A 470pF capacitor (C_{BYP}) connected from BYP to GND quiets this reference, providing a significant reduction in output noise. C_{BYP} reduces the regulator phase margin; when using C_{BYP} , output capacitors of 2.2 μ F or greater are generally required to maintain stability.

The start-up speed of the MIC5207 is inversely proportional to the size of the reference bypass capacitor. Applications requiring a slow ramp-up of output voltage should consider larger values of C_{BYP} . Likewise, if rapid turn-on is necessary, consider omitting C_{BYP} .

If output noise is not a major concern, omit C_{BYP} and leave BYP open.

Output Capacitor

An output capacitor is required between OUT and GND to prevent oscillation. The minimum size of the output capacitor is dependent upon whether a reference bypass capacitor is used. 1.0 μ F minimum is recommended when C_{BYP} is not used (see Figure 2). 2.2 μ F minimum is recommended when C_{BYP} is 470 μ F (see Figure 1). Larger values improve the regulator's transient response. The output capacitor value may be increased without limit.

The output capacitor should have an ESR (effective series resistance) of about 5 Ω or less and a resonant frequency above 1MHz. Most tantalum or aluminum electrolytic capacitors are adequate; film types will work, but are more expensive. Since many aluminum electrolytics have electrolytes that freeze at about -30°C, solid tantalums are recommended for operation below -25°C.

At lower values of output current, less output capacitance is required for output stability. The capacitor can be reduced to 0.47 μ F for current below 10mA or 0.33 μ F for currents below 1mA.

No-Load Stability

The MIC5207 will remain stable and in regulation with no load (other than the internal voltage divider) unlike many other voltage regulators. This is especially important in CMOS RAM keep-alive applications.

Fixed Regulator Applications

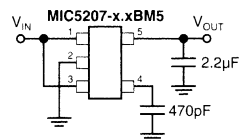

Figure 1. Low-Noise Fixed Voltage Application

Figure 1 includes a 470 μ F capacitor for low-noise operation and shows EN (pin 3) connected to IN (pin 1) for an application where enable/shutdown is not required. $C_{OUT} = 2.2\mu$ F minimum.

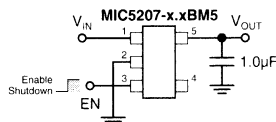

Figure 2. Basic Fixed Voltage Application

Figure 2 is an example of a basic configuration where the lowest-noise operation is not required. $C_{OUT} = 1\mu$ F minimum.

Adjustable Regulator Applications

Figure 3 shows the MIC5207BM5 adjustable output voltage configuration. Two resistors set the output voltage. The formula for output voltage is:

$$V_{OUT} = 1.242V \times \left(\frac{R2}{R1} + 1 \right)$$

Resistor values are not critical because ADJ (adjust) has a high input impedance, but for best results use resistors of 470k Ω or less. A capacitor from ADJ to ground provides greatly improved noise performance.

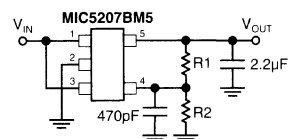

Figure 3. Low-Noise Adjustable Voltage Application

Figure 3 includes the optional 470pF noise bypass capacitor from ADJ to GND to reduce output noise.

Dual-Supply Operation

When used in dual supply systems where the regulator load is returned to a negative supply, the output voltage must be diode clamped to ground.

Thermal Considerations

Layout

The MIC5207-xxBM5 (5-lead SOT-23 package) has the following thermal characteristics when mounted on a single layer copper-clad printed circuit board.

PC Board Dielectric	θ_{JA}
FR4	220°C/W
Ceramic	200°C/W

Multilayer boards having a ground plane, wide traces near the pads, and large supply bus lines provide better thermal conductivity.

The “worst case” value of 220°C/W assumes no ground plane, minimum trace widths, and a FR4 material board.

Nominal Power Dissipation and Die Temperature

The MIC5207-xxBM5 at a 25°C ambient temperature will operate reliably at over 450mW power dissipation when mounted in the “worst case” manner described above. At an ambient temperature of 40°C, the device may safely dissipate over 380mW. These power levels are equivalent to a die temperature of 125°C, the maximum operating junction temperature for the MIC5207.

For additional heat sink characteristics, please refer to Micrel Application Hint 17, “Calculating P.C. Board Heat Sink Area For Surface Mount Packages”.

General Description

The MIC5201 is an efficient linear voltage regulator with very low dropout voltage (typically 17mV at light loads and 200mV at 100mA), and very low ground current (1mA at 100mA output), offering better than 1% initial accuracy with a logic compatible ON/OFF switching input. Designed especially for hand-held battery powered devices, the MIC5201 is switched by a CMOS or TTL compatible logic signal. This ENABLE control may be tied directly to V_{IN} if unneeded. When disabled, power consumption drops nearly to zero. The ground current of the MIC5201 increases only slightly in dropout, further prolonging battery life. Key MIC5201 features include protection against reversed battery, current limiting, and over-temperature shutdown.

The MIC5201 is available in several fixed voltages and accuracy configurations. It features the same pinout as the LT1121 with better performance. Other options are available; contact Micrel for details.

Features

- High output voltage accuracy
- Variety of output voltages
- Guaranteed 200mA output
- Low quiescent current
- Low dropout voltage
- Extremely tight load and line regulation
- Very low temperature coefficient
- Current and thermal limiting
- Reverse-battery protection
- Zero OFF mode current
- Logic-controlled electronic enable
- Available in SO-8 and SOT-223 packages

Applications

- Cellular Telephones
- Laptop, Notebook, and Palmtop Computers
- Battery Powered Equipment
- PCMCIA V_{CC} and V_{PP} Regulation/Switching
- Bar Code Scanners
- SMPS Post-Regulator/ DC to DC Modules
- High Efficiency Linear Power Supplies

Ordering Information

Part Number	Volts	Accuracy	Temperature Range*	Package
MIC5201BM	Adj	1%	-40°C to +125°C	SO-8
MIC5201-3.0BM	3.0	1%	-40°C to +125°C	SO-8
MIC5201-3.3BM	3.3	1%	-40°C to +125°C	SO-8
MIC5201-5.0BM	5.0	1%	-40°C to +125°C	SO-8
MIC5201-3.0BS	3.0	1%	-40°C to +125°C	SOT-223
MIC5201-3.3BS	3.3	1%	-40°C to +125°C	SOT-223
MIC5201-4.8BS	4.85	1%	-40°C to +125°C	SOT-223
MIC5201-5.0BS	5.0	1%	-40°C to +125°C	SOT-223

* Junction Temperature

Other voltages are available; contact Micrel for details.

Pin Configuration

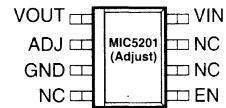

MIC5201BM Adjustable regulator

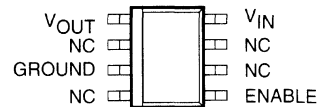

MIC5201-xxBM

Typical Application

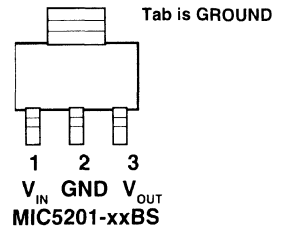
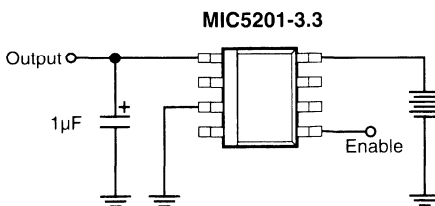

ENABLE may be tied directly to V_{IN}

Absolute Maximum Ratings

Absolute Maximum Ratings indicate limits beyond which damage to the device may occur. Electrical specifications do not apply when operating the device beyond its specified **Operating Ratings**.

Power Dissipation	Internally Limited
Lead Temperature (Soldering, 5 seconds)	260°C
Operating Junction Temperature Range	-40°C to +125°C
Input Supply Voltage	-20V to +60V
ENABLE Input Voltage	-20V to +60V
ESD Rating	> 2000V

Recommended Operating Conditions

Input Voltage	2.5V to 26V
Operating Junction Temperature Range	-40°C to +125°C
ENABLE Input Voltage	0V to V_{IN}

Electrical Characteristics

Limits in standard typeface are for $T_J = 25^\circ\text{C}$ and limits in **boldface** apply over the junction temperature range of -40°C to $+125^\circ\text{C}$. Unless otherwise specified, $V_{IN} = V_{OUT} + 1\text{V}$, $I_L = 100\mu\text{A}$, $C_L = 3.3\mu\text{F}$, and $V_{ENABLE} \geq 2.0\text{V}$

Symbol	Parameter	Conditions	Min	Typical	Max	Units
V_O	Output Voltage Accuracy	Variation from specified V_{OUT}	-1 -2		1 2	%
$\frac{\Delta V_O}{\Delta T}$	Output Voltage Temperature Coef.	(Note 2)		40	150	ppm/°C
$\frac{\Delta V_O}{V_O}$	Line Regulation	$V_{IN} = V_{OUT} + 1\text{V}$ to 26V		0.004	0.20 0.40	%
$\frac{\Delta V_O}{V_O}$	Load Regulation	$I_L = 0.1\text{mA}$ to 200mA (Note 3)		0.04	0.16 0.30	%
$V_{IN} - V_O$	Dropout Voltage (Note 4)	$I_L = 100\mu\text{A}$ $I_L = 20\text{mA}$ $I_L = 50\text{mA}$ $I_L = 100\text{mA}$ $I_L = 200\text{mA}$		17 130 180 225 270	400	mV
I_{GND}	Quiescent Current	$V_{ENABLE} \leq 0.7\text{V}$ (Shutdown)		0.01		μA
I_{GND}	Ground Pin Current	$V_{ENABLE} \geq 2.0\text{V}$, $I_L = 100\mu\text{A}$ $I_L = 20\text{mA}$ $I_L = 50\text{mA}$ $I_L = 100\text{mA}$ $I_L = 200\text{mA}$		130 270 500 1000 3.0	400 2000	μA mA
PSRR	Ripple Rejection			75		dB
I_{GNDDO}	Ground Pin Current at Dropout	$V_{IN} = 0.5\text{V}$ less than specified V_{OUT} $I_L = 100\mu\text{A}$ (Note 5)		270	330	μA
I_{LIMIT}	Current Limit	$V_{OUT} = 0\text{V}$		280	500	mA
$\frac{\Delta V_O}{\Delta P_D}$	Thermal Regulation	(Note 6)		0.05		%/W
e_n	Output Noise			100		μV

ENABLE Input

V_{IL}	Input Voltage Level Logic Low Logic High	OFF ON	2.0		0.7	V
I_{IL} I_{IH}	ENABLE Input Current	$V_{IL} \leq 0.7\text{V}$ $V_{IH} \geq 2.0\text{V}$		0.01 15	1 50	μA

Symbol	Parameter	Conditions	Min	Typical	Max	Units
Reference (MIC5201BM adjustable version only)						
V_{REF}	Reference Voltage		1.223 1.217	1.242	1.255 1.267	V
i_{IL}	Reference Voltage Temperature Coefficient			20		ppm/°C

- Note 1:** Absolute maximum ratings indicate limits beyond which damage to the component may occur. Electrical specifications do not apply when operating the device outside of its rated operating conditions. The maximum allowable power dissipation is a function of the maximum junction temperature, $T_{J(MAX)}$, the junction-to-ambient thermal resistance, θ_{JA} , and the ambient temperature, T_A . The maximum allowable power dissipation at any ambient temperature is calculated using: $P_{(MAX)} = (T_{J(MAX)} - T_A) \div \theta_{JA}$. Exceeding the maximum allowable power dissipation will result in excessive die temperature, and the regulator will go into thermal shutdown. The θ_{JC} of the MIC5201-xxBS is 15°C/W and θ_{JA} for the MIC5201BM is 160°C/W mounted on a PC board (see "Thermal Considerations" section for further details).
- Note 2:** Output voltage temperature coefficient is defined as the worst case voltage change divided by the total temperature range.
- Note 3:** Regulation is measured at constant junction temperature using low duty cycle pulse testing. Parts are tested for load regulation in the load range from 0.1mA to 200mA. Changes in output voltage due to heating effects are covered by the thermal regulation specification.
- Note 4:** Dropout Voltage is defined as the input to output differential at which the output voltage drops 2% below its nominal value measured at 1V differential.
- Note 5:** Ground pin current is the regulator quiescent current plus pass transistor base current. The total current drawn from the supply is the sum of the load current plus the ground pin current.
- Note 6:** Thermal regulation is defined as the change in output voltage at a time T after a change in power dissipation is applied, excluding load or line regulation effects. Specifications are for a 200mA load pulse at $V_{IN} = 26V$ for $T = 10ms$.

Typical Characteristics

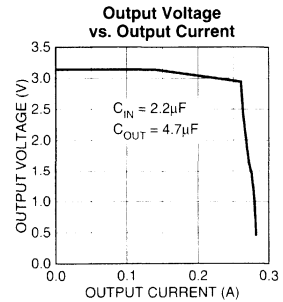
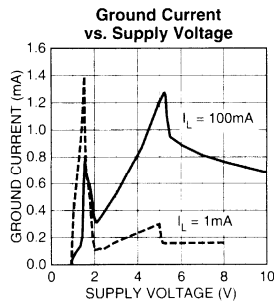
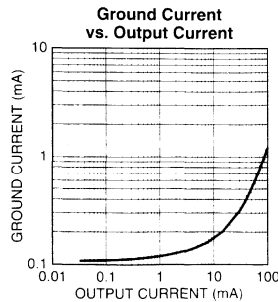
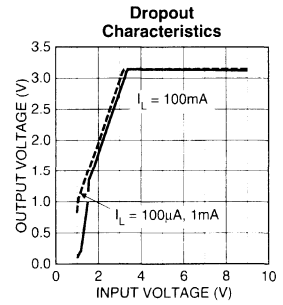
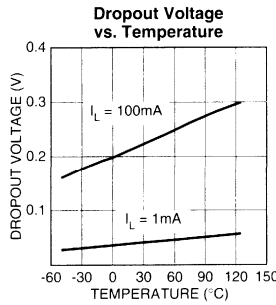
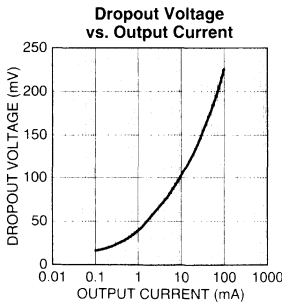

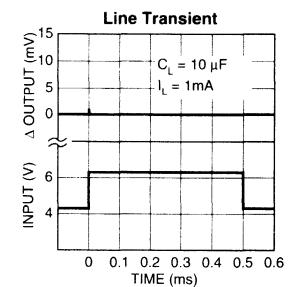
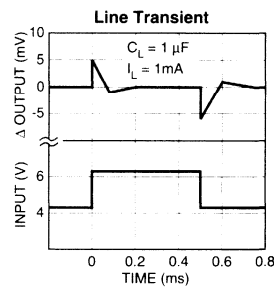
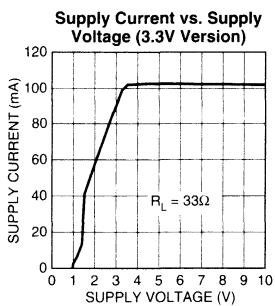
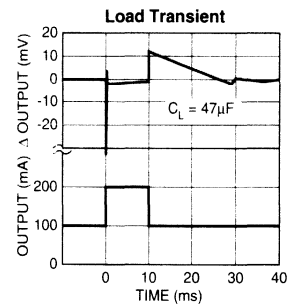
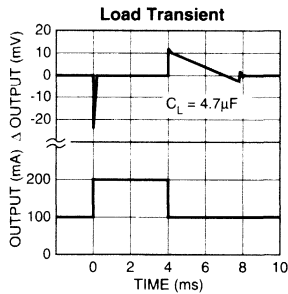
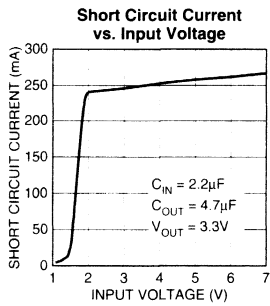
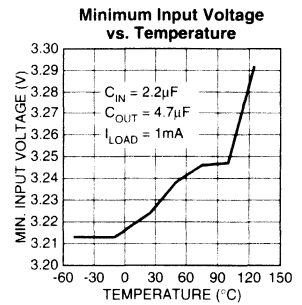
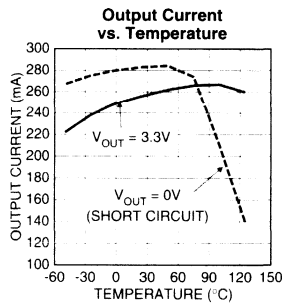
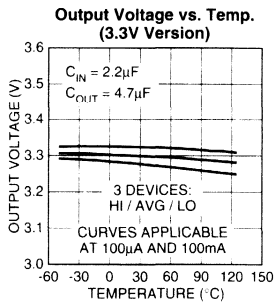
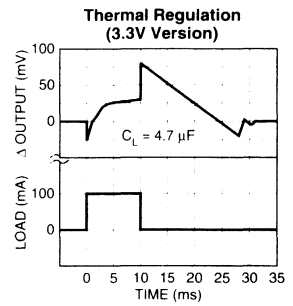
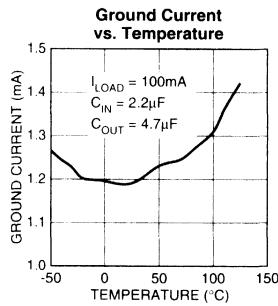
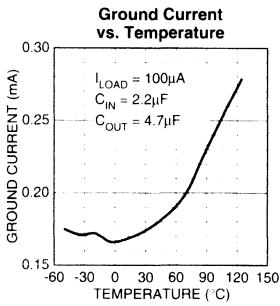

Supply Current vs. Supply Voltage (3.3V Version)

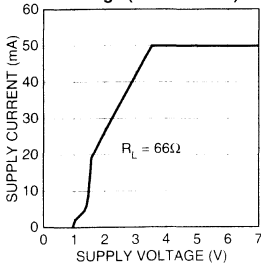

Enable Transient (3.3V Version)

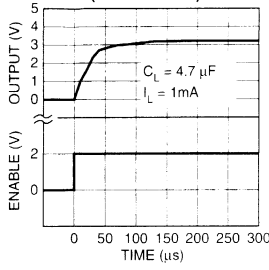

Enable Transient (3.3V Version)

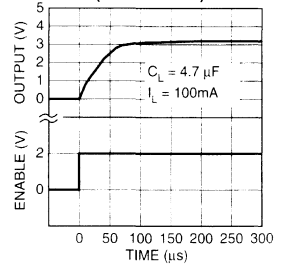

Output Impedance

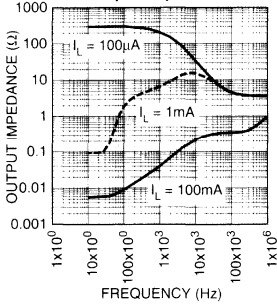

Enable Current Threshold vs. Temperature

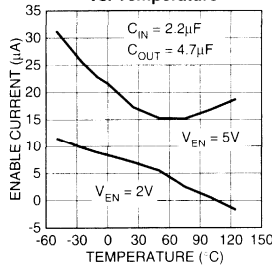

Enable Voltage Threshold vs. Temperature

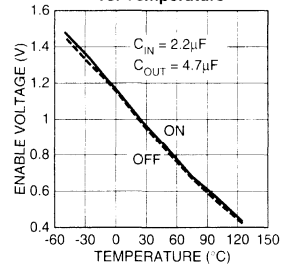

Ripple vs. Frequency

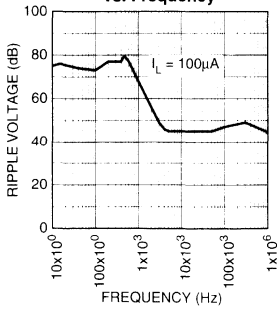

Ripple vs. Frequency

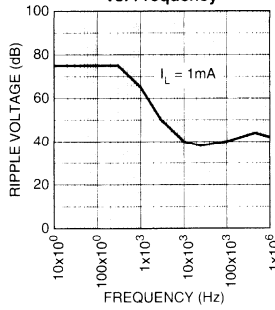

Ripple vs. Frequency

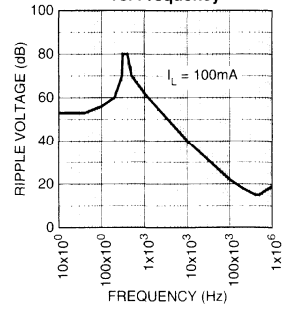

Applications Information

External Capacitors

A 1 μ F capacitor is recommended between the MIC5201 output and ground to prevent oscillations due to instability. Larger values serve to improve the regulator's transient response. Most types of tantalum or aluminum electrolytics will be adequate; film types will work, but are costly and therefore not recommended. Many aluminum electrolytics have electrolytes that freeze at about -30°C, so solid tantalums are recommended for operation below -25°C. The important parameters of the capacitor are an effective series resistance of about 5 Ω or less and a resonant frequency above 500kHz. The value of this capacitor may be increased without limit.

At lower values of output current, less output capacitance is required for output stability. The capacitor can be reduced to 0.47 μ F for current below 10mA or 0.33 μ F for currents below 1 mA. A 1 μ F capacitor should be placed from the MIC5201 input to ground if there is more than 10 inches of wire between the input and the AC filter capacitor or if a battery is used as the input.

The MIC5201 will remain stable and in regulation with no load in addition to the internal voltage divider, unlike many other voltage regulators. This is especially important in CMOS RAM keep-alive applications.

When used in dual supply systems where the regulator load is returned to a negative supply, the output voltage must be diode clamped to ground.

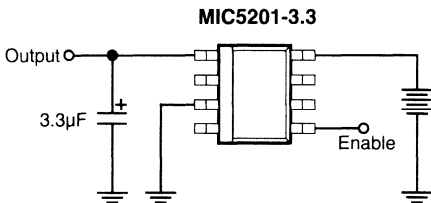

MIC5201 Fixed voltage application.

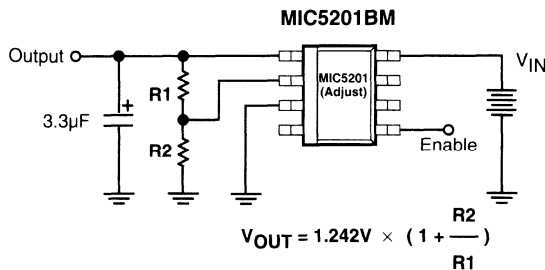

MIC5201 Adjustable application. A capacitor from the adjust pin (pin 2) to ground will decrease high frequency noise on the output.

Thermal Considerations

Part I. Layout

The MIC5201-xxBM (8-pin surface mount package) has the following thermal characteristics when mounted on a single layer copper-clad printed circuit board.

PC Board Dielectric	θ_{JA}
FR4	160°C/W
Ceramic	120°C/W

Multi-layer boards having a ground plane, wide traces near the pads, and large supply bus lines provide better thermal conductivity.

The "worst case" value of 160°C/W assumes no ground plane, minimum trace widths, and a FR4 material board.

Part II. Nominal Power Dissipation and Die Temperature

The MIC5201-xxBM at a 25°C ambient temperature will operate reliably at up to 625mW power dissipation when mounted in the "worst case" manner described above. At an ambient temperature of 55°C, the device may safely dissipate 440mW. These power levels are equivalent to a die temperature of 125°C, the recommended maximum temperature for non-military grade silicon integrated circuits.

For MIC5201-xxBS (SOT-223 package) heat sink characteristics, please refer to Micrel Application Hint 17, "P.C. Board Heat Sinking".

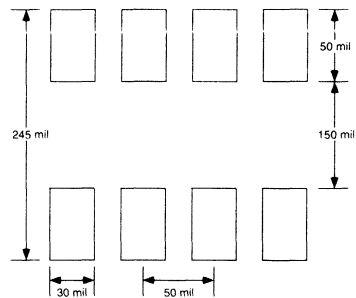

Minimum recommended board pad size, SO-8.

General Description

The MIC2954 is a "bulletproof" efficient voltage regulator with very low dropout voltage (typically 40mV at light loads and 375mV at 250mA), and low quiescent current (120µA typical). The quiescent current of the MIC2954 increases only slightly in dropout, thus prolonging battery life. Key MIC2954 features include protection against reversed battery, fold-back current limiting, and automotive load dump protection (60V positive transient).

The MIC2954-07/08BM is an adjustable version that includes an error flag output that warns of a low output voltage, which is often due to failing batteries on the input. This may also be used as a power-on reset. A logic-compatible shutdown input is provided which enables the regulator to be switched on and off. This part may be pin-strapped for 5V output, or programmed from 1.24 V to 29 V with the use of two external resistors.

The MIC2954 is available in two voltage tolerances, $\pm 0.5\%$ maximum and $\pm 1\%$ maximum. Both are guaranteed for junction temperatures from -40°C to $+125^{\circ}\text{C}$.

The MIC2954 has a very low output voltage temperature coefficient and extremely good load and line regulation (0.04% typical).

Features

- High accuracy 5V, guaranteed 250mA output
- Low quiescent current
- Low dropout voltage
- Extremely tight load and line regulation
- Very low temperature coefficient
- Current and thermal limiting
- Input can withstand -20V reverse battery and $+60\text{V}$ positive transients
- Error flag warns of output dropout
- Logic-controlled electronic shutdown
- Output programmable from 1.24V to 29V (MIC2954-07/08BM)
- Available in TO-220, TO-92, and Surface Mount SOT-223 and SO-8 packages.

Applications

- Battery Powered Equipment
- Cellular Telephones
- Laptop, Notebook, and Palmtop Computers
- PCMCIA V_{CC} and V_{PP} Regulation/Switching
- Bar Code Scanners
- Automotive Electronics
- SMPS Post-Regulator/ DC to DC Modules
- Voltage Reference
- High Efficiency Linear Power Supplies

Pin Configuration

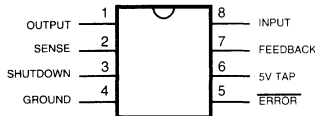

SO Package
(MIC2954-07BM, -08BM)

TAB IS GROUND

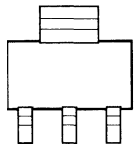

MIC2954-xxBS

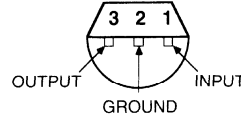

Bottom View
TO-92 Package
(MIC2954-02BZ, -03BZ)

TAB CONNECTED TO GROUND PIN

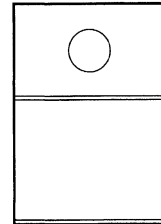

TO-220 Package Front View
(MIC2954-02BT, -03BT)

Ordering Information

Part Number	Temperature Range*	Package	Accuracy
MIC2954-02BT	-40°C to $+125^{\circ}\text{C}$	TO-220	0.5%
MIC2954-03BT	-40°C to $+125^{\circ}\text{C}$	TO-220	1.0%
MIC2954-02BS	-40°C to $+125^{\circ}\text{C}$	SOT-223	0.5%
MIC2954-03BS	-40°C to $+125^{\circ}\text{C}$	SOT-223	1.0%
MIC2954-02BZ	-40°C to $+125^{\circ}\text{C}$	TO-92	0.5%
MIC2954-03BZ	-40°C to $+125^{\circ}\text{C}$	TO-92	1.0%
MIC2954-07BM	-40°C to $+125^{\circ}\text{C}$	8-Pin SO-8	0.5%
MIC2954-08BM	-40°C to $+125^{\circ}\text{C}$	8-Pin SO-8	1.0%

* Junction temperatures

MIC2954-02BT/BZ & 2954-03BT/BZ Block Diagram

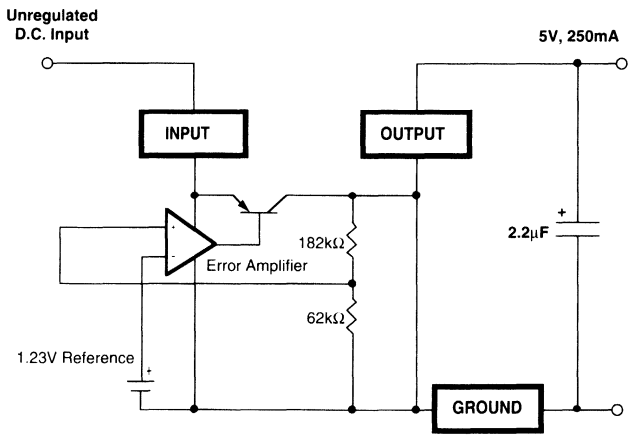

MIC2954-07BM & 2954-08BM Block Diagram

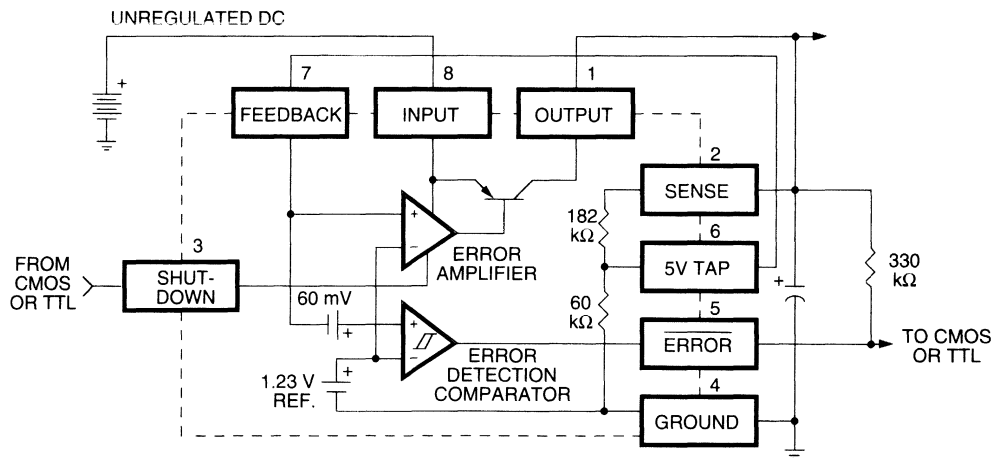

Absolute Maximum Ratings

If Military/Aerospace specified devices are required, contact your local Micrel representative/distributor for availability and specifications.

Power Dissipation (Note 1)	Internally Limited	Input Supply Voltage	-20V to +60V
Lead Temperature (Soldering, 5 seconds)	260°C	Feedback Input Voltage (Notes 10 and 11)	-1.5V to +26V
Storage Temperature Range	-65°C to +150°C	Shutdown Input Voltage	-0.3V to +30V
Operating Junction Temperature Range	-40°C to +125°C	Error Comparator Output Voltage	-0.3V to +30V

Electrical Characteristics

Limits in standard typeface are for $T_j = 25^\circ\text{C}$ and limits in **boldface** apply over the full operating temperature range.

Unless otherwise specified, $V_{IN} = 6\text{V}$, $I_L = 1\text{mA}$, $C_L = 2.2\mu\text{F}$. The MIC2954-07BM, -08BM Feedback pin is tied to the 5V Tap and Output is tied to Output Sense ($V_{OUT} = 5\text{V}$) and $V_{SHUTDOWN} \leq 0.6\text{V}$.

Symbol	Parameter	Conditions	Typical	MIC2954-02/-07		MIC2954-03/-08		Units
				Min	Max	Min	Max	
V_O	Output Voltage		5.0	4.975	5.025	4.950	5.050	V
		$1\text{mA} \leq I_L \leq 250\text{mA}$	5.0	4.940	5.060	4.900	5.100	
				4.930	5.070	4.880	5.120	
$\frac{\Delta V_O}{\Delta T}$	Output Voltage Temperature Coef.	(Note 2)	20		100		150	ppm/°C
$\frac{\Delta V_O}{V_O}$	Line Regulation	$V_{IN} = 6\text{V to } 26\text{V}$	0.03 (Note 3)		0.10 0.20		0.20 0.40	%
$\frac{\Delta V_O}{V_O}$	Load Regulation	$I_L = 1 \text{ to } 250\text{mA}$	0.04		0.16 0.20		0.20 0.30	%
		(Note 4)						
$V_{IN} - V_O$	Dropout Voltage (Note 5)	$I_L = 1\text{mA}$	60		100 150		100 150	mV
		$I_L = 50\text{mA}$	220		250 420		250 420	
		$I_L = 100\text{mA}$	250		300 450		300 450	
		$I_L = 250\text{mA}$	375		450 600		450 600	
I_{GND}	Ground Pin Current (Note 6)	$I_L = 1\text{mA}$	140		200 300		200 300	μA
		$I_L = 50\text{mA}$	0.5		1 2		1 2	mA
		$I_L = 100\text{mA}$	1.7		2.5 3.5		2.5 3.5	
		$I_L = 250\text{mA}$	5		9 12		9 12	
I_{GNDDO}	Ground Pin Current at Dropout (Note 6)	$V_{IN} = 4.5\text{V}$	180		300		300	μA
I_{LIMIT}	Current Limit	$V_{OUT} = 0\text{V}$ (Note 7)			750 800		750 800	mA
$\frac{\Delta V_O}{\Delta P_D}$	Thermal Regulation	(Note 8)	0.05		0.2		0.2	%/W
e_n	Output Noise Voltage (10Hz to 100kHz)	$C_L = 2.2\mu\text{F}$	400					$\mu\text{V RMS}$
		$C_L = 33\mu\text{F}$	260					
		$I_L = 100\text{mA}$						

Electrical Characteristics, MIC2954-07BM/-08BM,(Continued)

Parameter	Conditions	MIC2954-07BM			MIC2954-08BM			Units
		Typ.	Min	Max	Typ.	Min	Max	
Reference Voltage		1.235	1.220 1.200	1.250 1.260	1.235	1.210 1.200	1.260 1.270	V V max
Reference Voltage	(Note 9)		1.190	1.270		1.185	1.285	V
Feedback Pin Bias Current		20		40 60	20		40 60	nA
Reference Voltage Temperature Coefficient	(Note 8)	20			50			ppm/°C
Feedback Pin Bias Current Temperature Coefficient		0.1			0.1			nA/°C

Error Comparator

Output Leakage Current	$V_{OH} = 30V$	0.01		1.00 2.00	0.01		1.00 2.00	μA
Output Low Voltage	$V_{IN} = 4.5V$ $I_{OL} = 400\mu A$	150		250 400	150		250 400	mV
Upper Threshold Voltage	(Note 10)	60	40 25		60	40 25		mV
Lower Threshold Voltage	(Note 10)	75		95 140	75		95 140	mV
Hysteresis	(Note 10)	15			15			mV

Shutdown Input

Input Logic Voltage	Low (ON) High (OFF)	1.3		0.7 2.0	1.3		0.7 2.0	V
Shutdown Pin Input Current	$V_{SHUTDOWN} = 2.4V$	30		50 100	30		50 100	μA
	$V_{SHUTDOWN} = 30V$	450		600 750	450		600 750	μA
Regulator Output Current in Shutdown	(Note 11)	3		10 20	3		10 20	μA

Note 1: Absolute maximum ratings indicate limits beyond which damage to the component may occur. Electrical specifications do not apply when operating the device outside of its rated operating conditions. The maximum allowable power dissipation is a function of the maximum junction temperature, $T_{J(MAX)}$, the junction-to-ambient thermal resistance, θ_{JA} , and the ambient temperature, T_A . The maximum allowable power dissipation at any ambient temperature is calculated using: $P_{(MAX)} = (T_{J(MAX)} - T_A) / \theta_{JA}$. Exceeding the maximum allowable power dissipation will result in excessive die temperature, and the regulator will go into thermal shutdown. The junction to ambient thermal resistance of the MIC2954BM is 160°C/W mounted on a PC board. (See MIC2954BM Thermal Characteristics section for further information.)

Note 2: Output voltage temperature coefficient is defined as the worst case voltage change divided by the total temperature range.

Note 3: Line regulation for the MIC2954 is tested at 125°C for $I_L = 1$ mA. For $I_L = 100$ μ A and $T_J = 125$ °C, line regulation is guaranteed by design to 0.2%. See Typical Performance Characteristics for line regulation versus temperature and load current.

Note 4: Regulation is measured at constant junction temperature using low duty cycle pulse testing. Changes in output voltage due to heating effects are covered by the thermal regulation specification.

Note 5: Dropout Voltage is defined as the input to output differential at which the output voltage drops 100 mV below its nominal value measured at 1V differential. At very low values of programmed output voltage, the minimum input supply voltage of 2 V (2.3 V over temperature) must be taken into account.

Note 6: Ground pin current is the regulator quiescent current. The total current drawn from the source is the sum of the load current plus the ground pin current.

Note 7: The MIC2954 features fold-back current limiting. The short circuit ($V_{OUT} = 0$ V) current limit is less than the maximum current with normal output voltage.

Note 8: Thermal regulation is defined as the change in output voltage at a time T after a change in power dissipation is applied, excluding load or line regulation effects. Specifications are for a 200mA load pulse at $V_{IN} = 20$ V (a 4W pulse) for T = 10ms.

Note 9: $V_{REF} \leq V_{OUT} \leq (V_{IN} - 1$ V), 2.3 V $\leq V_{IN} \leq 30$ V, 100 μ A $< I_L \leq 250$ mA, $T_J \leq T_{JMAX}$.

Note 10: Comparator thresholds are expressed in terms of a voltage differential at the Feedback terminal below the nominal reference voltage measured at 6V input. To express these thresholds in terms of output voltage change, multiply by the error amplifier gain = $V_{OUT} / V_{REF} = (R1 + R2) / R2$. For example, at a programmed output voltage of 5V, the Error output is guaranteed to go low when the output drops by 95 mV $\times 5$ V/ 1.235 V = 384 mV. Thresholds remain constant as a percent of V_{OUT} as V_{OUT} is varied, with the dropout warning occurring at typically 5% below nominal, 7.5% guaranteed.

Note 11: $V_{SHUTDOWN} \geq 2$ V, $V_{IN} \leq 30$ V, $V_{OUT} = 0$, with Feedback pin tied to 5V Tap.

Note 12: When used in dual supply systems where the regulator load is returned to a negative supply, the output voltage must be diode clamped to ground.

Note 13: Maximum positive supply voltage of 60 V must be of limited duration (< 100 ms) and duty cycle ($\leq 1\%$). The maximum continuous supply voltage is 30 V.

Note 14: Thermal resistance (θ_{JC}) of the TO-220 package is 2.5°C/W, and 15°C/W for the SOT-223. Thermal resistance (θ_{JA}) of the TO-92 package is 180°C/W with 0.4" leads and 160°C/W with 0.25" leads.

Typical Characteristics

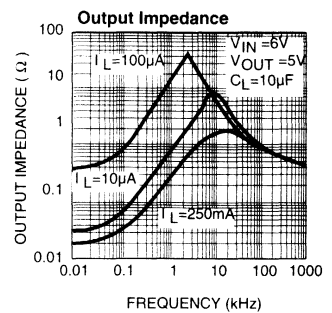
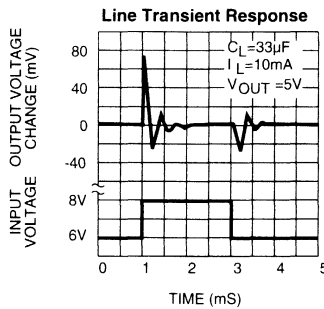
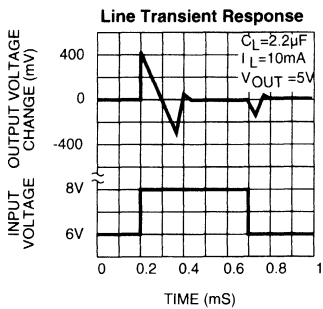
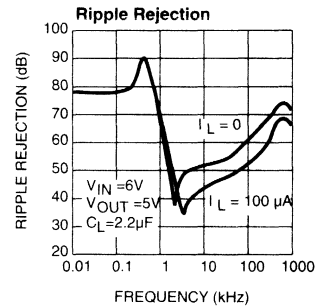
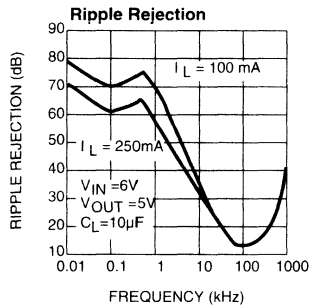
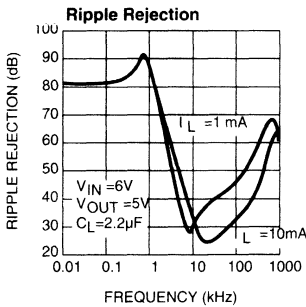
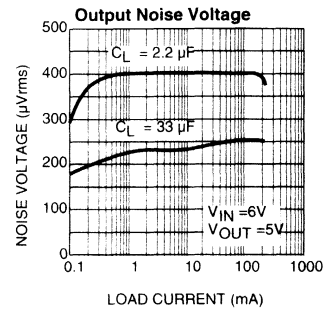
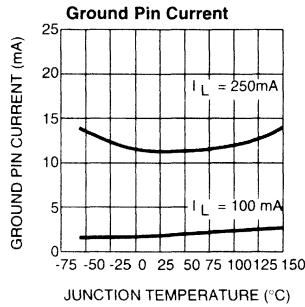
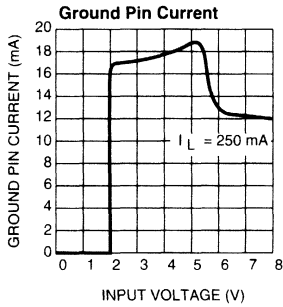
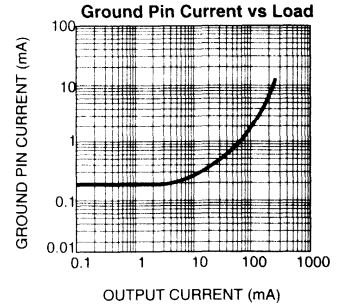
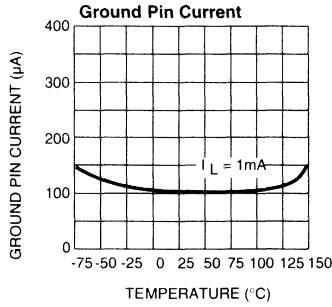
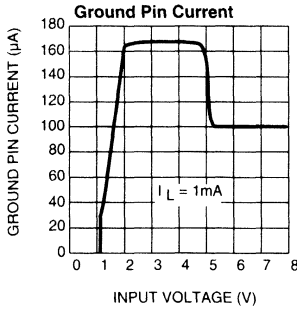

Typical Characteristics, Continued

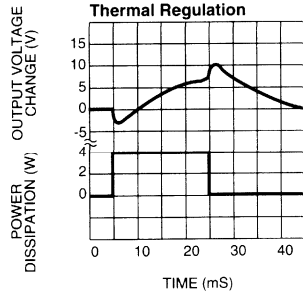
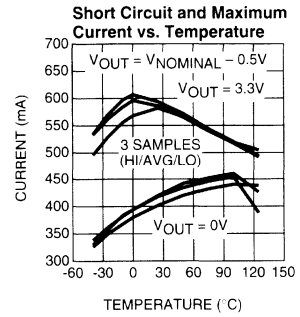
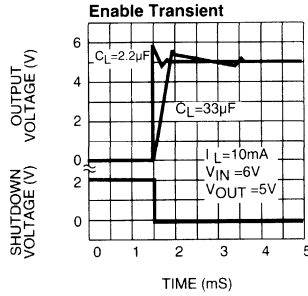
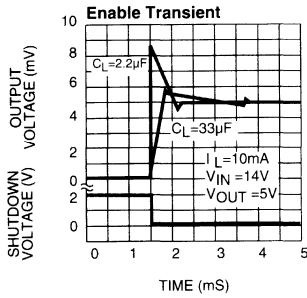
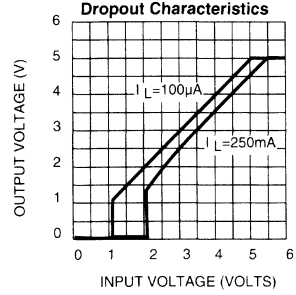
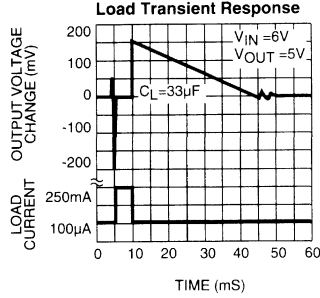
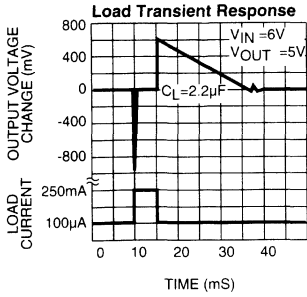

Applications Information

External Capacitors

A 2.2 μ F (or greater) capacitor is required between the MIC2954 output and ground to prevent oscillations due to instability. Most types of tantalum or aluminum electrolytics will be adequate; film types will work, but are costly and therefore not recommended. Many aluminum electrolytics have electrolytes that freeze at about -30°C , so solid tantalums are recommended for operation below -25°C . The important parameters of the capacitor are an effective series resistance of about 5 Ω or less and a resonant frequency above 500kHz. The value of this capacitor may be increased without limit.

At lower values of output current, less output capacitance is required for output stability. The capacitor can be reduced to 0.5 μ F for current below 10mA or 0.15 μ F for currents below 1 mA. Adjusting the MIC2954-07BM/-08BM to voltages below 5V runs the error amplifier at lower gains so that more output capacitance is needed. For the worst-case situation of a 250mA load at 1.23V output (Output shorted to Feedback) a 5 μ F (or greater) capacitor should be used.

The MIC2954 will remain in regulation with a minimum load of 1mA. When setting the output voltage of the MIC2954-07BM/-08BM version with external resistors, the current through these resistors may be included as a portion of the minimum load.

A 0.1 μ F capacitor should be placed from the MIC2954 input to ground if there is more than 10 inches of wire between the input and the AC filter capacitor or if a battery is used as the input.

Stray capacitance to the MIC2954-07BM/-08BM Feedback terminal (pin 7) can cause instability. This may especially be a problem when using high value external resistors to set the output voltage. Adding a 100pF capacitor between Output and Feedback and increasing the output capacitor to at least 3.3 μ F will remedy this.

Error Detection Comparator Output (MIC2954-07BM/-08BM)

A logic low output will be produced by the comparator whenever the MIC2954BM output falls out of regulation by more than approximately 5%. This figure is the comparator's built-in offset of about 60mV divided by the 1.235V reference voltage. (Refer to the block diagram on Page 1). This trip level remains "5% below normal" regardless of the programmed output voltage of the MIC2954-07BM/-08BM. For example, the error flag trip level is typically 4.75V for a 5V output or 11.4V for a 12V output. The out of regulation condition may be due either to low input voltage, current limiting, or thermal limiting.

Figure 1 is a timing diagram depicting the $\overline{\text{ERROR}}$ signal and the regulated output voltage as the MIC2954-07BM/-08BM input is ramped up and down. The $\overline{\text{ERROR}}$ signal becomes valid (low) at about 1.3V input. It goes high at about 5V input (the input voltage at which $V_{\text{OUT}} = 4.75$). Since the MIC2954-07BM/-08BM's dropout voltage is load-dependent (see curve

in Typical Performance Characteristics), the input voltage trip point (about 5V) will vary with the load current. The output voltage trip point (approximately 4.75V) does not vary with load.

The error comparator has an open-collector output which requires an external pull-up resistor. Depending on system requirements, this resistor may be returned to the 5V output or some other supply voltage. In determining a value for this resistor, note that while the output is rated to sink 400 μ A, this sink current adds to battery drain in a low battery condition. Suggested values range from 100k to 1M Ω . The resistor is not required if this output is unused.

Programming the Output Voltage (MIC2954-07BM/-08BM)

The MIC2954-07BM/-08BM may be pin-strapped for 5V using its internal voltage divider by tying Pin 1 (output) to Pin 2 (sense) and Pin 7 (feedback) to Pin 6 (5V Tap). Alternatively, it may be programmed for any output voltage between its 1.235V reference and its 30V maximum rating. An external pair of resistors is required, as shown in Figure 3.

The complete equation for the output voltage is

$$V_{\text{OUT}} = V_{\text{REF}} \times \{ 1 + R_1/R_2 \} + I_{\text{FB}} R_1$$

where V_{REF} is the nominal 1.235 reference voltage and I_{FB} is the feedback pin bias current, nominally -20nA. The minimum recommended load current of 1 μ A forces an upper limit of 1.2M Ω on the value of R_2 , if the regulator must work with no load (a condition often found in CMOS in standby). I_{FB} will produce a 2% typical error in V_{OUT} which may be eliminated at room temperature by trimming R_1 . For better accuracy, choosing $R_2 = 100\text{k}$ reduces this error to 0.17% while increasing the resistor program current to 12 μ A. Since the MIC2954-07BM/-08BM typically draws 60 μ A at no load with Pin 2 open-circuited, this is a negligible addition.

Reducing Output Noise

In reference applications it may be advantageous to reduce the AC noise present at the output. One method is to reduce the regulator bandwidth by increasing the size of the output capacitor. This is relatively inefficient, as increasing the

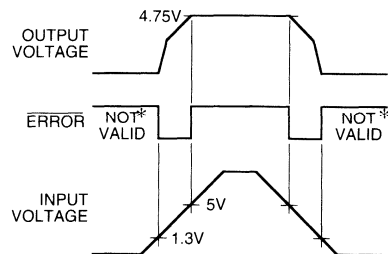

* SEE APPLICATIONS INFORMATION

Figure 1. $\overline{\text{ERROR}}$ Output Timing

capacitor from 1 μF to 220 μF only decreases the noise from 430 μV to 160 μV_{RMS} for a 100kHz bandwidth at 5V output. Noise can be reduced fourfold by a bypass capacitor across R_1 , since it reduces the high frequency gain from 4 to unity. Pick:

$$C_{\text{BYPASS}} \cong \frac{1}{2\pi R_1 \cdot 200 \text{ Hz}}$$

or about 0.01 μF . When doing this, the output capacitor must be increased to 3.3 μF to maintain stability. These changes reduce the output noise from 430 μV to 100 $\mu\text{V rms}$ for a 100 kHz bandwidth at 5V output. With the bypass capacitor added, noise no longer scales with output voltage so that improvements are more dramatic at higher output voltages.

Automotive Applications

The MIC2954 is ideally suited for automotive applications for a variety of reasons. It will operate over a wide range of input voltages with very low dropout voltages (40mV at light loads), and very low quiescent currents (75 μA typical). These features are necessary for use in battery powered systems, such as automobiles. It is a "bulletproof" device with the ability to survive both reverse battery (negative transients up to 20V below ground), and load dump (positive transients up to 60V) conditions. A wide operating temperature range with low temperature coefficients is yet another reason to use these versatile regulators in automotive designs.

Typical Applications

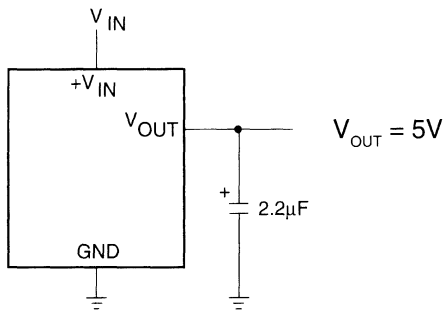
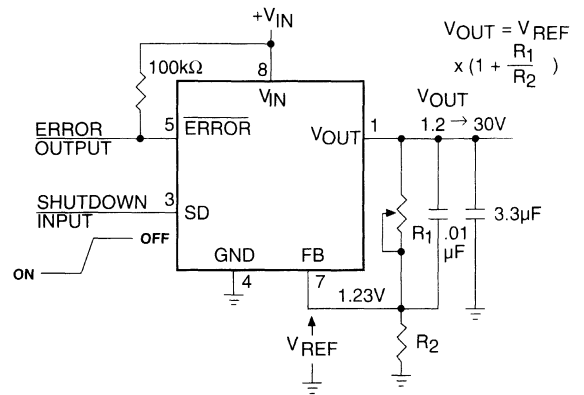

Figure 2. MIC2954 Fixed +5V Regulator



NOTE: PINS 2 AND 6 ARE LEFT OPEN

*SEE APPLICATIONS INFORMATION

Figure 3. MIC2954-07BM/-08BM Adjustable Regulator

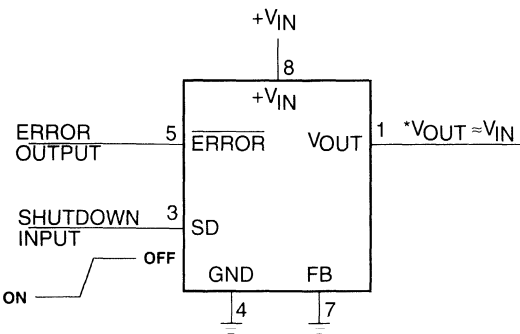

*MINIMUM INPUT-OUTPUT VOLTAGE RANGES FROM 40mV TO 400mV, DEPENDING ON LOAD CURRENT.

Figure 4. MIC2954-07BM/-08BM Wide Input Voltage Range Current Limiter

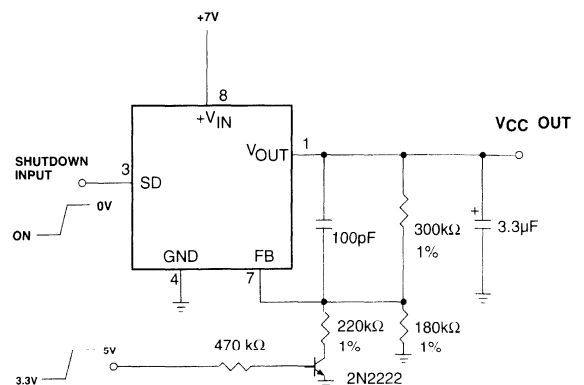

PIN 3 LOW= ENABLE OUTPUT. Q1 ON = 3.3V, Q1 OFF = 5.0V.

Figure 5. MIC2954-07BM/-08BM 5.0V or 3.3V Selectable Regulator with Shutdown.

MIC2954-07BM/-08BM Thermal Calculations

Layout Considerations

The MIC2954-07BM/-08BM (8-Pin Surface Mount Package) has the following thermal characteristics when mounted on a single layer copper-clad printed circuit board.

Pad Layout (minimum recommended geometry)

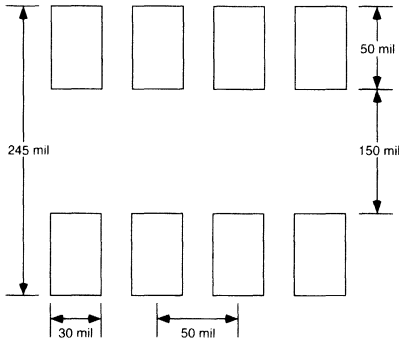

PC Board Dielectric Material	θ_{JA}
FR4	160°C/W
Ceramic	120°C/W

Multi-layer boards having a ground plane, wide traces near the pads, and large supply bus lines provide better thermal conductivity.

Our calculations will use the "worst case" value of 160°C/W, which assumes no ground plane, minimum trace widths, and a FR4 material board.

Nominal Power Dissipation and Die Temperature

The MIC2954-07BM/-08BM at a 55°C ambient temperature will operate reliably at up to 440mW power dissipation when mounted in the "worst case" manner described above. This power level is equivalent to a die temperature of 125°C, the recommended maximum temperature for non-military grade silicon integrated circuits.

Schematic Diagram

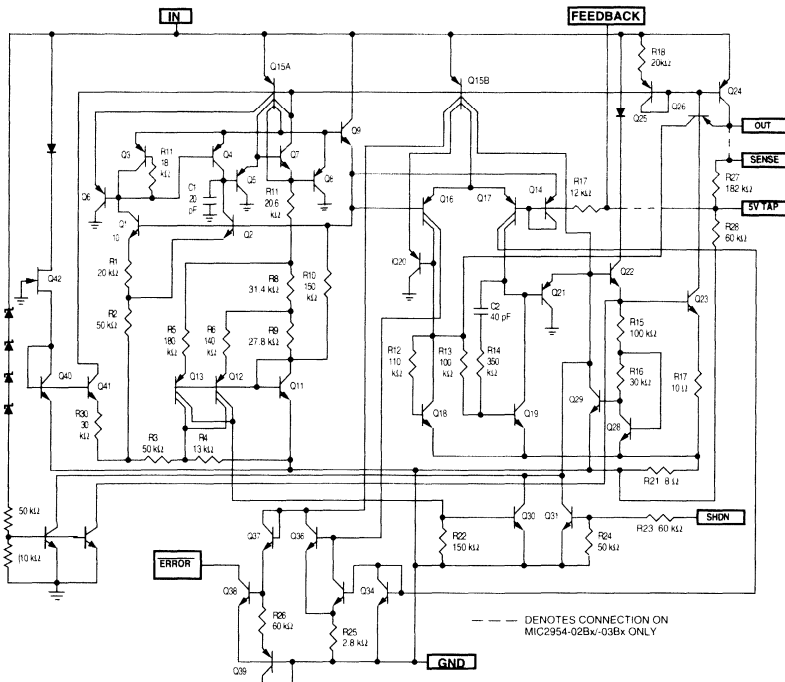

General Description

The MIC2920A family are "bulletproof" efficient voltage regulators with very low drop out voltage (typically 40mV at light loads and 370mV at 250mA), and very low quiescent current (140µA typical). The quiescent current of the MIC2920A increases only slightly in dropout, thus prolonging battery life. Key MIC2920A features include protection against reversed battery, fold-back current limiting, and automotive "load dump" protection (60V positive transient).

The MIC2920 is available in several configurations. The MIC2920A-xx devices are three pin fixed voltage regulators available in 3.3V, 4.85V, 5V, and 12V outputs. The MIC29201 is a fixed regulator offering logic compatible ON/OFF switching input and an error flag output. This flag may also be used as a power-on reset signal. A logic-compatible shutdown input is provided on the adjustable MIC29202, which enables the regulator to be switched on and off. The MIC29203 is a five pin adjustable version that includes an error flag output that warns of a low output voltage, which is often due to failing batteries on the input. The eight pin DIP and SOIC adjustable version, the MIC29204, includes both shutdown and error flag pins, and may be pin-strapped for 5V output, or programmed from 1.24 V to 26 V with the use of two external resistors.

Features

- High output voltage accuracy
- Guaranteed 400mA output
- Low quiescent current
- Low dropout voltage
- Extremely tight load and line regulation
- Very low temperature coefficient
- Current and thermal limiting
- Input can withstand -20V reverse battery and +60V positive transients
- Error flag warns of output dropout
- Logic-controlled electronic shutdown
- Output programmable from 1.24V to 26V (MIC29202/ MIC29203/MIC29204)
- Available in TO-220, TO-220-5, DIP, CerDIP, and Surface Mount TO-263-5, SOT-223, and SO-8 packages.

Applications

- Battery Powered Equipment
- Cellular Telephones
- Laptop, Notebook, and Palmtop Computers
- PCMCIA V_{CC} and V_{PP} Regulation/Switching
- Bar Code Scanners
- Automotive Electronics
- SMPS Post-Regulator/ DC to DC Modules
- Voltage Reference
- High Efficiency Linear Power Supplies

Pin Configuration

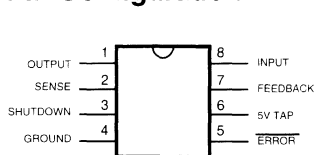

SO/DIP Packages
(MIC29204BJ/M/N)

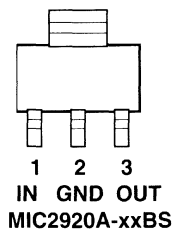

TO-263-5 Package
(MIC2920A-xxBS)

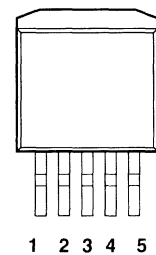

TO-263-5 Package
(MIC29201/29202/29203BU)

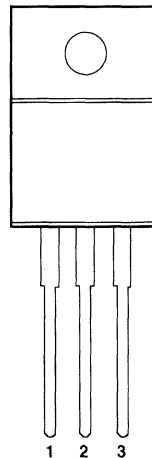

TO-220 Package
(MIC2920A-xxBT)

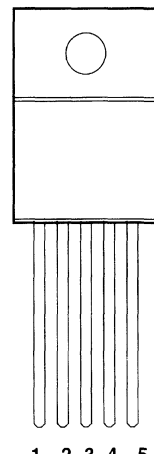

TO-220-5 Package
(MIC29201/29202/29203BT)

Five Lead Package Pin Functions:

	MIC29201	MIC29202	MIC29203
1) Error	Adjust	Error	Error
2) Input	Shutdown	Adjust	Adjust
3) Ground	Ground	Ground	Ground
4) Output	Input	Input	Input
5) Shutdown	Output	Output	Output

The TAB is Ground on the SOT-223, TO-220, and TO-263 packages.

Ordering Information			
Part Number	Voltage	Temperature Range*	Package
MIC2920A-3.3BS	3.3	-40°C to +125°C	SOT-223
MIC2920A-3.3BT	3.3	-40°C to +125°C	TO-220
MIC2920A-4.8BS	4.85	-40°C to +125°C	SOT-223
MIC2920A-4.8BT	4.85	-40°C to +125°C	TO-220
MIC2920A-5.0BS	5.0	-40°C to +125°C	SOT-223
MIC2920A-5.0BT	5.0	-40°C to +125°C	TO-220
MIC2920A-12BS	12	-40°C to +125°C	SOT-223
MIC2920A-12BT	12	-40°C to +125°C	TO-220
MIC29201-3.3BT	3.3	-40°C to +125°C	TO-220-5
MIC29201-3.3BU	3.3	-40°C to +125°C	TO-263-5
MIC29201-4.8BT	4.85	-40°C to +125°C	TO-220-5
MIC29201-4.8BU	4.85	-40°C to +125°C	TO-263-5
MIC29201-5.0BT	5.0	-40°C to +125°C	TO-220-5
MIC29201-5.0BU	5.0	-40°C to +125°C	TO-263-5
MIC29201-12BT	12	-40°C to +125°C	TO-220-5
MIC29201-12BU	12	-40°C to +125°C	TO-263-5
MIC29202BT	Adj	-40°C to +125°C	TO-220-5
MIC29202BU	Adj	-40°C to +125°C	TO-263-5
MIC29203BT	Adj	-40°C to +125°C	TO-220-5
MIC29203BU	Adj	-40°C to +125°C	TO-263-5
MIC29204BM	5 and Adj	-40°C to +125°C	SO-8
MIC29204BN	5 and Adj	-40°C to +125°C	8-pin PDIP

Absolute Maximum Ratings

If Military/Aerospace specified devices are required, contact your local Micrel representative/distributor for availability and specifications.

Power Dissipation (Note 1) Internally Limited
 Lead Temperature (Soldering, 5 seconds) 260°C
 Storage Temperature Range -65°C to +150°C
 Operating Junction Temperature Range -40°C to +125°C

Thermal Characteristics:

SOT-223 θ_{JC} 15°C/W
 TO-220 θ_{JC} 3°C/W
 TO-263 θ_{JC} 3°C/W
 8-Pin CerDIP θ_{JA} 130°C/W
 8-Pin Plastic DIP θ_{JA} 105°C/W
 8-Pin SOIC θ_{JA} See Note 1
 Input Supply Voltage -20V to +60V
 Operating Input Supply Voltage 2V¹ to 26V
 Adjust Input Voltage (Notes 9 and 10) -1.5V to +26V
 Shutdown Input Voltage -0.3V to +30V
 Error Comparator Output Voltage -0.3V to +30V

¹ Across the full operating temperature, the minimum input voltage range for full output current is 4.3V to 26V. Output will remain in-regulation at lower output voltages and low current loads down to an input of 2V at 25°C.

* Junction temperatures

Electrical Characteristics

Limits in standard typeface are for $T_J = 25^\circ\text{C}$ and limits in **boldface** apply over the full operating temperature range. Unless otherwise specified, $V_{IN} = V_{OUT} + 1\text{V}$, $I_L = 1\text{mA}$, $C_L = 10\mu\text{F}$. Adjustable version are set for an output of 5V. The MIC29202 $V_{SHUTDOWN} \leq 0.7\text{V}$. The eight pin MIC29204 is configured with the Adjust pin tied to the 5V Tap, the Output is tied to Output Sense ($V_{OUT} = 5\text{V}$), and $V_{SHUTDOWN} \leq 0.7\text{V}$.

Symbol	Parameter	Conditions	Min	Typical	Max	Units	
V_O	Output Voltage Accuracy	Variation from factory trimmed V_{OUT}	-1		1	%	
			-2		2		
		$1\text{mA} \leq I_L \leq 400\text{mA}$, across temp. range	-2.5		2.5		
		MIC2920A-12 and 29201-12 only	-1.5		1.5		
		$1\text{mA} \leq I_L \leq 400\text{mA}$, across temp. range	-3		3		
			-4		4		
$\frac{\Delta V_O}{\Delta T}$	Output Voltage Temperature Coef.	(Note 2)		20	100	ppm/ $^\circ\text{C}$	
		$V_{OUT} > 10\text{V}$ only		80	350		
$\frac{\Delta V_O}{V_O}$	Line Regulation	$V_{IN} = V_{OUT} + 1\text{V}$ to 26V		0.03	0.10	%	
					0.40		
$\frac{\Delta V_O}{V_O}$	Load Regulation	$I_L = 1$ to 250mA (Note 3)		0.04	0.16	%	
					0.30		
$V_{IN} - V_O$	Dropout Voltage (Note 4)	$I_L = 1\text{mA}$		100	150	mV	
		$I_L = 100\text{mA}$		250	180		
		$I_L = 250\text{mA}$	$V_{OUT} > 10\text{V}$ only		350		
		$I_L = 400\text{mA}$	$V_{OUT} > 10\text{V}$ only		370		
					500		600
				450	750		
I_{GND}	Ground Pin Current (Note 5)	$I_L = 1\text{mA}$		140	200	μA	
		$I_L = 100\text{mA}$		1.3	2	mA	
		$I_L = 250\text{mA}$		5	9		
		$I_L = 400\text{mA}$		13	12		
					15		
I_{GNDDO}	Ground Pin Current at Dropout (Note 5)	$V_{IN} = 0.5\text{V}$ less than designed V_{OUT} ($V_{OUT} \geq 3.3\text{V}$) $I_O = 1\text{mA}$		180	400	μA	
I_{LIMIT}	Current Limit	$V_{OUT} = 0\text{V}$ (Note 6)		425	1000	mA	
					1200		
$\frac{\Delta V_O}{\Delta P_D}$	Thermal Regulation	(Note 7)		0.05	0.2	%/W	
e_n	Output Noise Voltage (10Hz to 100kHz) $I_L = 100\text{mA}$	$C_L = 10\mu\text{F}$		400		$\mu\text{V RMS}$	
		$C_L = 100\mu\text{F}$		260			

Electrical Characteristics (Continued)**MIC29202, MIC29203, MIC29204**

Parameter	Conditions	Min	Typ	Max	Units
Reference Voltage	MIC29202/29203	1.223 1.210	1.235	1.247 1.260	V
Reference Voltage	MIC29202/29203 (Note 8)	1.204		1.266	V
Reference Voltage	MIC29204	1.210 1.200	1.235	1.260 1.270	V
Reference Voltage	MIC29204 (Note 8)	1.185		1.285	V
Adjust Pin Bias Current			20	40 60	nA
Reference Voltage Temperature Coefficient	(Note 7)		20		ppm/°C
Adjust Pin Bias Current Temperature Coefficient			0.1		nA/°C

Error Comparator MIC29201, MIC29203, MIC29204

Output Leakage Current	$V_{OH} = 26V$		0.01	1.00 2.00	μA
Output Low Voltage	$V_{IN} = 4.5V$ $I_{OL} = 250\mu A$		150	250 400	mV
Upper Threshold Voltage	(Note 9)	40 25	60		mV
Lower Threshold Voltage	(Note 9)		75	95 140	mV
Hysteresis	(Note 9)		15		mV

Shutdown Input MIC29201, MIC29202, MIC29204

Input Logic Voltage	Low (ON) High (OFF)	2.0	1.3	0.7	V
Shutdown Pin Input Current	$V_{SHUTDOWN} = 2.4V$		30	50 100	μA
	$V_{SHUTDOWN} = 26V$		450	600 750	μA
Regulator Output Current in Shutdown	(Note 10)		3	10 20	μA

General Note: Devices are ESD protected; however, handling precautions are recommended.

Note 1: Absolute maximum ratings indicate limits beyond which damage to the component may occur. Electrical specifications do not apply when operating the device outside of its rated operating conditions. The maximum allowable power dissipation is a function of the maximum junction temperature, $T_{J(MAX)}$, the junction-to-ambient thermal resistance, θ_{JA} , and the ambient temperature, T_A . The maximum allowable power dissipation at any ambient temperature is calculated using: $P_{(MAX)} = (T_{J(MAX)} - T_A) / \theta_{JA}$. Exceeding the maximum allowable power dissipation will result in excessive die temperature, and the regulator will go into thermal shutdown. The junction to ambient thermal resistance of the MIC29204BM is 160°C/W mounted on a PC board.

Note 2: Output voltage temperature coefficient is defined as the worst case voltage change divided by the total temperature range.

Note 3: Regulation is measured at constant junction temperature using low duty cycle pulse testing. Changes in output voltage due to heating effects are covered by the thermal regulation specification.

Note 4: Dropout Voltage is defined as the input to output differential at which the output voltage drops 100mV below its nominal value measured at 1V differential. At low values of programmed output voltage, the minimum input supply voltage of 4.3V over temperature must be taken into account. The MIC2920A operates down to 2V of input at reduced output current at 25°C.

Note 5: Ground pin current is the regulator quiescent current. The total current drawn from the supply is the sum of the load current plus the ground pin current.

Note 6: The MIC2920A features fold-back current limiting. The short circuit ($V_{OUT} = 0V$) current limit is less than the maximum current with normal output voltage.

Note 7: Thermal regulation is defined as the change in output voltage at a time T after a change in power dissipation is applied, excluding load or line regulation effects. Specifications are for a 200mA load pulse at $V_{IN} = 20V$ (a 4W pulse) for T = 10ms.

Note 8: $V_{REF} \leq V_{OUT} \leq (V_{IN} - 1V)$, $4.3V \leq V_{IN} \leq 26V$, $1mA < I_L \leq 400mA$, $T_J \leq T_{JMAX}$

Note 9: Comparator thresholds are expressed in terms of a voltage differential at the Adjust terminal below the nominal reference voltage measured at 6V input. To express these thresholds in terms of output voltage change, multiply by the error amplifier gain = $V_{OUT} / V_{REF} = (R1 + R2) / R2$. For example, at a programmed output voltage of 5V, the Error output is guaranteed to go low when the output drops by $95mV \times 5V / 1.235V = 384mV$. Thresholds remain constant as a percent of V_{OUT} as V_{OUT} is varied, with the dropout warning occurring at typically 5% below nominal, 7.7% guaranteed.

Note 10: $V_{SHUTDOWN} \geq 2V$, $V_{IN} \leq 26V$, $V_{OUT} = 0$, with Adjust pin tied to 5V Tap or to the R1, R2 junction (see Figure 3) with $R1 \geq 150k\Omega$.

Note 11: When used in dual supply systems where the regulator load is returned to a negative supply, the output voltage must be diode clamped to ground.

Note 12: Maximum positive supply voltage of 60V must be of limited duration (< 100ms) and duty cycle ($\leq 1\%$). The maximum continuous supply voltage is 26V.

Schematic Diagram

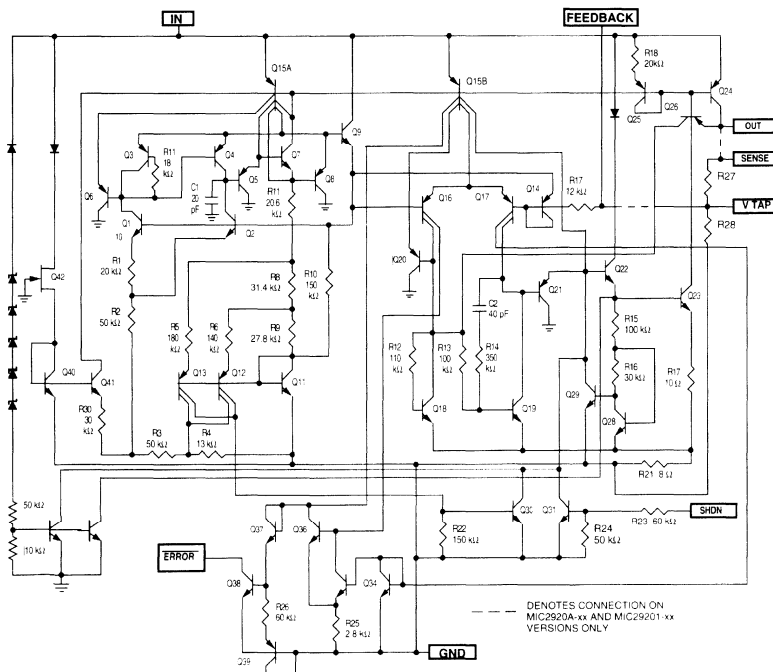

Typical Characteristics

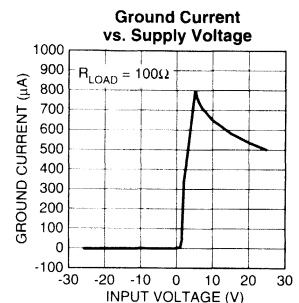
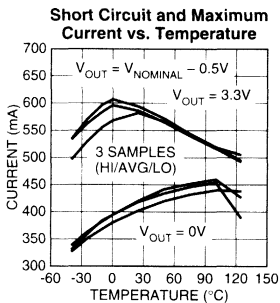
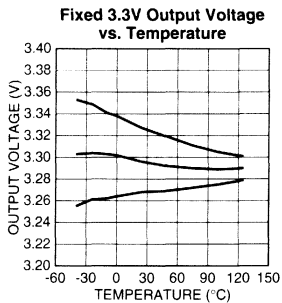
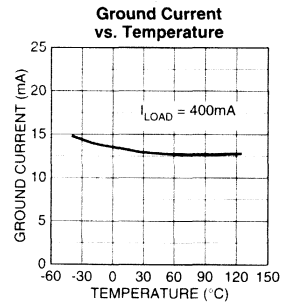
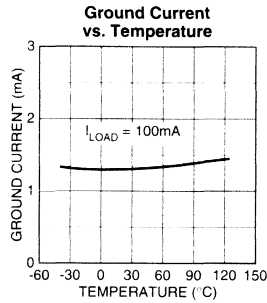
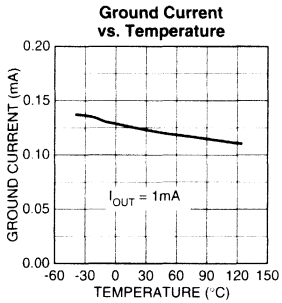
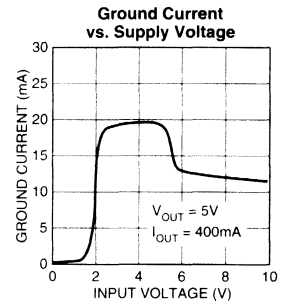
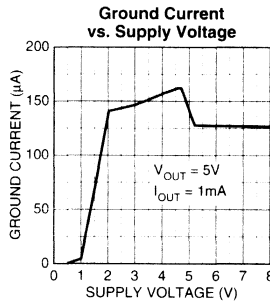
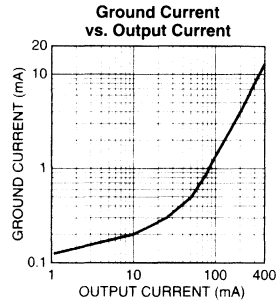
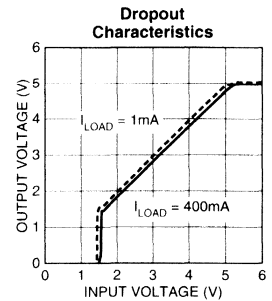
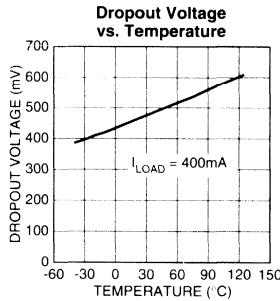
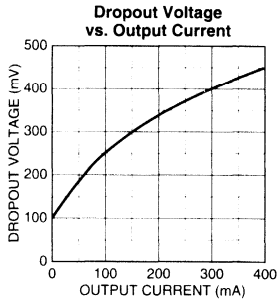

MIC29201/2 Shutdown Current vs. Temperature

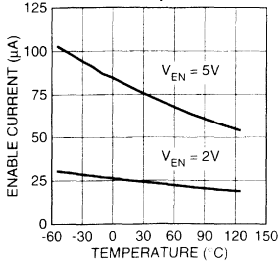

Load Transient

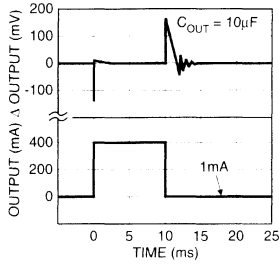

Load Transient

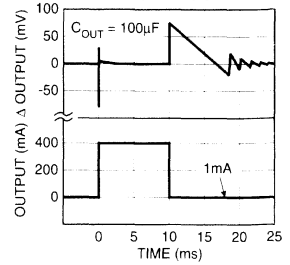

MIC29202/3 Adjust Pin Current vs. Temperature

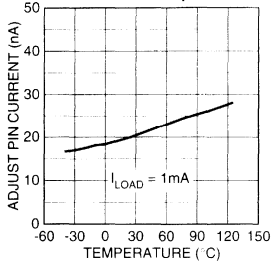

Line Transient

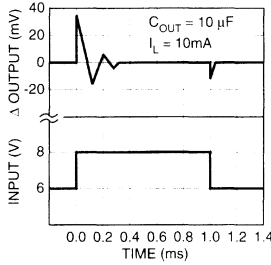

Line Transient

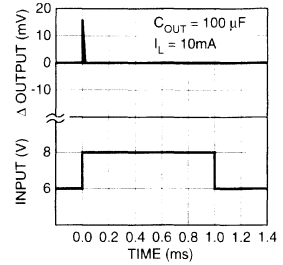

Output Impedance vs. Frequency

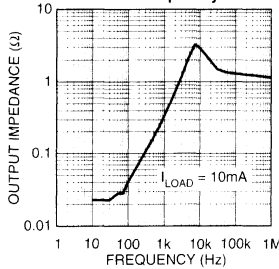

Ripple Rejection

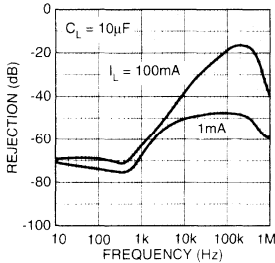

Applications Information

External Capacitors

A 10 μ F (or greater) capacitor is required between the MIC2920A output and ground to prevent oscillations due to instability. Most types of tantalum or aluminum electrolytics will be adequate; film types will work, but are costly and therefore not recommended. Many aluminum electrolytics have electrolytes that freeze at about -30°C , so solid tantalums are recommended for operation below -25°C . The important parameters of the capacitor are an effective series resistance of about 5 Ω or less and a resonant frequency above 500kHz. The value of this capacitor may be increased without limit.

At lower values of output current, less output capacitance is required for output stability. The capacitor can be reduced to 2.2 μ F for current below 10mA or 1 μ F for currents below 1 mA. Adjusting the MIC29202/29203/29204 to voltages below 5V runs the error amplifier at lower gains so that more output capacitance is needed. For the worst-case situation of a 500mA load at 1.23V output (Output shorted to Adjust) a 47 μ F (or greater) capacitor should be used.

The MIC2920A/29201 will remain in regulation with a minimum load of 1mA. When setting the output voltage of the MIC29202/29203/29204 versions with external resistors, the current through these resistors may be included as a portion of the minimum load.

A 1 μ F capacitor should be placed from the MIC2920A input to ground if there is more than 10 inches of wire between the input and the AC filter capacitor or if a battery is used as the input.

Stray capacitance to the MIC29202/29203/29204 Adjust terminal can cause instability. This may especially be a problem when using high value external resistors to set the output voltage. Adding a 100pF capacitor between Output and Adjust and increasing the output capacitor to at least 3.3 μ F will remedy this.

Error Detection Comparator Output (MIC29201/ MIC29203/MIC29204)

A logic low output will be produced by the comparator whenever the MIC29201/29203/29204 output falls out of regulation by more than approximately 5%. This figure is the comparator's built-in offset of about 75mV divided by the 1.235V reference voltage. (Refer to the block diagram on Page 1). This trip level remains "5% below normal" regardless of the programmed output voltage of the MIC29201/29203/29204. For example, the error flag trip level is typically 4.75V for a 5V output or 11.4V for a 12V output. The out of regulation condition may be due either to low input voltage, extremely high input voltage, current limiting, or thermal limiting.

Figure 1 is a timing diagram depicting the ERROR signal and the regulated output voltage as the MIC29201/29203/29204 input is ramped up and down. The ERROR signal becomes

valid (low) at about 1.3V input. It goes high at about 5V input (the input voltage at which $V_{\text{OUT}} = 4.75$). Since the MIC29201/29203/29204's dropout voltage is load-dependent (see curve in Typical Performance Characteristics), the input voltage trip point (about 5V) will vary with the load current. The output voltage trip point (approximately 4.75V) does not vary with load.

The error comparator has an NPN open-collector output which requires an external pull-up resistor. Depending on system requirements, this resistor may be returned to the 5V output or some other supply voltage. In determining a value for this resistor, note that while the output is rated to sink 250 μ A, this sink current adds to battery drain in a low battery condition. Suggested values range from 100k to 1M Ω . The resistor is not required if this output is unused.

Programming the Output Voltage (MIC29202/ MIC29203/29204)

The MIC29202/29203/29204 may be programmed for any output voltage between its 1.235V reference and its 26V maximum rating, using an external pair of resistors, as shown in Figure 3.

The complete equation for the output voltage is

$$V_{\text{OUT}} = V_{\text{REF}} \times \{ 1 + R_1/R_2 \} - |I_{\text{FB}}| R_1$$

where V_{REF} is the nominal 1.235 reference voltage and I_{FB} is the Adjust pin bias current, nominally 20nA. The minimum recommended load current of 1 μ A forces an upper limit of 1.2M Ω on the value of R_2 , if the regulator must work with no load (a condition often found in CMOS in standby). I_{FB} will produce a -2% typical error in V_{OUT} which may be eliminated at room temperature by trimming R_1 . For better accuracy, choosing $R_2 = 100\text{k}$ reduces this error to 0.17% while increasing the resistor program current to 12 μ A. Since the MIC29202/29203/29204 typically draws 110 μ A at no load with SHUTDOWN open-circuited, this is a negligible addition. The MIC29204 may be pin-strapped for 5V using the internal voltage divider by tying Pin 1 (output) to Pin 2 (sense) and Pin 7 (Adjust) to Pin 6 (V Tap).

Reducing Output Noise

In reference applications it may be advantageous to reduce the AC noise present at the output. One method is to reduce the regulator bandwidth by increasing the size of the output

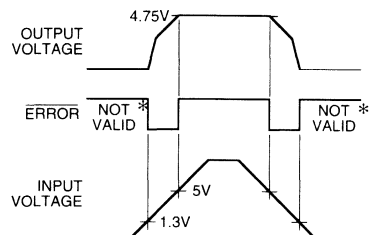

* SEE APPLICATIONS INFORMATION

Figure 1. ERROR Output Timing

capacitor. This is relatively inefficient, as increasing the capacitor from 1 μF to 220 μF only decreases the noise from 430 μV to 160 μV_{RMS} for a 100kHz bandwidth at 5V output. Noise can be reduced fourfold by a bypass capacitor across R_1 , since it reduces the high frequency gain from 4 to unity. Pick

$$C_{\text{BYPASS}} \cong \frac{1}{2\pi R_1 \cdot 200 \text{ Hz}}$$

or about 0.01 μF . When doing this, the output capacitor must be increased to 10 μF to maintain stability. These changes reduce the output noise from 430 μV to 100 μV rms for a 100 kHz bandwidth at 5V output. With the bypass capacitor added, noise no longer scales with output voltage so that improvements are more dramatic at higher output voltages.

Typical Applications

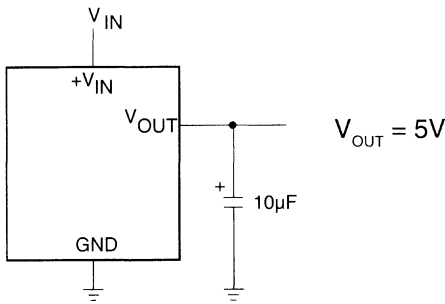
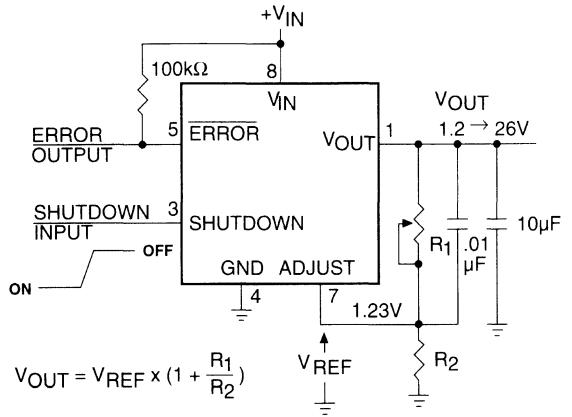

Figure 2. MIC2920A-5.0 Fixed +5V Regulator

Automotive Applications

The MIC2920A is ideally suited for automotive applications for a variety of reasons. It will operate over a wide range of input voltages with very low dropout voltages (40mV at light loads), and very low quiescent currents (100 μA typical). These features are necessary for use in battery powered systems, such as automobiles. It is a "bulletproof" device with the ability to survive both reverse battery (negative transients up to 20V below ground), and load dump (positive transients up to 60V) conditions. A wide operating temperature range with low temperature coefficients is yet another reason to use these versatile regulators in automotive designs.



NOTE: PINS 2 AND 6 ARE LEFT OPEN

Figure 3. MIC29202/29203/29204 Adjustable Regulator. Pinout is for MIC29204.

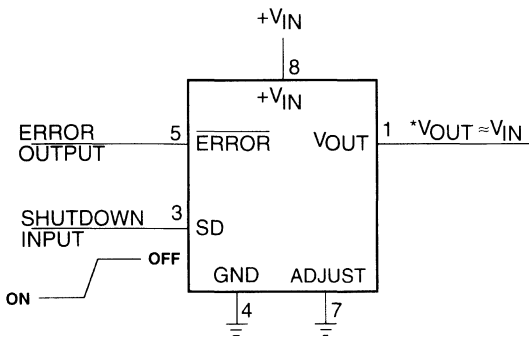

*MINIMUM INPUT-OUTPUT VOLTAGE RANGES FROM 40mV TO 400mV, DEPENDING ON LOAD CURRENT.

Figure 4. MIC29204 Wide Input Voltage Range Current Limiter

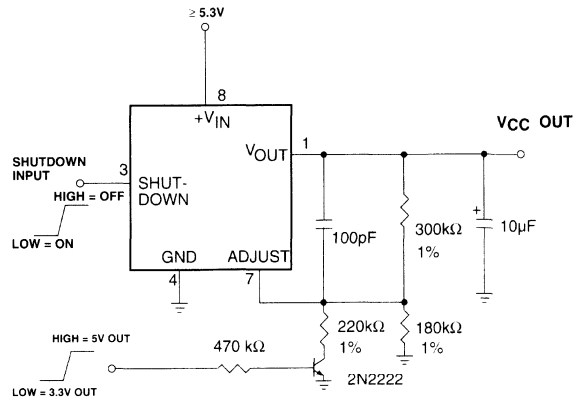

PIN 3 LOW = ENABLE OUTPUT. Q1 ON = 3.3V, Q1 OFF = 5.0V.

Figure 5. MIC29202/29203/29204 5.0V or 3.3V Selectable Regulator with Shutdown. Pinout is for MIC29204.



MIC2937A/29371/29372/29373

750mA Low-Dropout Voltage Regulator

Preliminary Information

General Description

The MIC2937A family are "bulletproof" efficient voltage regulators with very low dropout voltage (typically 40mV at light loads and 300mV at 500mA), and very low quiescent current (160µA typical). The quiescent current of the MIC2937A increases only slightly in dropout, thus prolonging battery life. Key MIC2937A features include protection against reversed battery, fold-back current limiting, and automotive "load dump" protection (60V positive transient).

The MIC2937 is available in several configurations. The MIC2937A-xx devices are three pin fixed voltage regulators with 3.3V, 5V, and 12V outputs available. The MIC29371 is a fixed regulator offering logic compatible ON/OFF switching input and an error flag output. This flag may also be used as a power-on reset signal. A logic-compatible shutdown input is provided on the adjustable MIC29372, which enables the regulator to be switched on and off. The MIC29373 is a five pin adjustable version that includes an error flag output that warns of a low output voltage, which is often due to failing batteries on the input.

Features

- High output voltage accuracy
- Guaranteed 750mA output
- Low quiescent current
- Low dropout voltage
- Extremely tight load and line regulation
- Very low temperature coefficient
- Current and thermal limiting
- Input can withstand -20V reverse battery and +60V positive transients
- Error flag warns of output dropout
- Logic-controlled electronic shutdown
- Output programmable from 1.24V to 26V(MIC29372/ MIC29373)
- Available in TO-220, TO-263, TO-220-5, and TO-263-5 packages.

Applications

- Battery Powered Equipment
- Cellular Telephones
- Laptop, Notebook, and Palmtop Computers
- PCMCIA V_{CC} and V_{PP} Regulation/Switching
- Bar Code Scanners
- Automotive Electronics
- SMPS Post-Regulator/ DC to DC Modules
- High Efficiency Linear Power Supplies

Pin Configuration

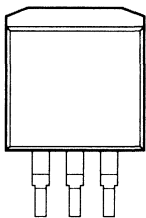

INPUT GROUND OUTPUT
TO-263 Package
(MIC2937A-xxBU)

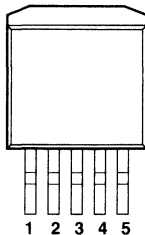

TO-263-5 Package
(MIC29371/29372/29373BU)

Five Lead Package Pin Functions:

	MIC29371	MIC29372	MIC29373
1)	Error	Adjust	Error
2)	Input	Shutdown	Adjust
3)	Ground	Ground	Ground
4)	Output	Input	Input
5)	Shutdown	Output	Output

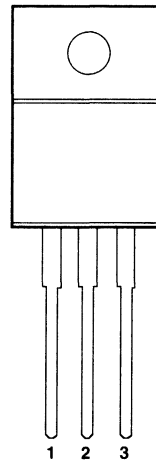

INPUT GROUND OUTPUT
TO-220 Package
(MIC2937A-xxBT)

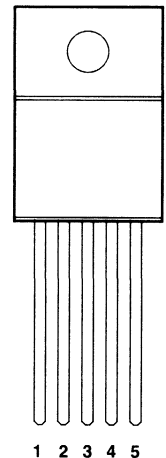

TO-220-5 Package
(MIC29371/29372/29373BT)

The TAB is Ground on the TO-220 and TO-263 packages.

Ordering Information			
Part Number	Voltage	Temperature Range*	Package
MIC2937A-3.3BU	3.3	-40°C to +125°C	TO-263-3
MIC2937A-3.3BT	3.3	-40°C to +125°C	TO-220
MIC2937A-5.0BU	5.0	-40°C to +125°C	TO-263-3
MIC2937A-5.0BT	5.0	-40°C to +125°C	TO-220
MIC2937A-12BU	12	-40°C to +125°C	TO-263-3
MIC2937A-12BT	12	-40°C to +125°C	TO-220
MIC29371-3.3BT	3.3	-40°C to +125°C	TO-220-5
MIC29371-3.3BU	3.3	-40°C to +125°C	TO-263-5
MIC29371-5.0BT	5.0	-40°C to +125°C	TO-220-5
MIC29371-5.0BU	5.0	-40°C to +125°C	TO-263-5
MIC29371-12BT	12	-40°C to +125°C	TO-220-5
MIC29371-12BU	12	-40°C to +125°C	TO-263-5
MIC29372BT	Adj	-40°C to +125°C	TO-220-5
MIC29372BU	Adj	-40°C to +125°C	TO-263-5
MIC29373BT	Adj	-40°C to +125°C	TO-220-5
MIC29373BU	Adj	-40°C to +125°C	TO-263-5

* Junction temperatures

Absolute Maximum Ratings

If Military/Aerospace specified devices are required, contact your local Micrel representative/distributor for availability and specifications.

Power Dissipation (Note 1) Internally Limited
 Lead Temperature (Soldering, 5 seconds) 260°C
 Storage Temperature Range -65°C to +150°C
 Operating Junction Temperature Range
 TO-220 θ_{JC} -40°C to +125°C
 TO-263 θ_{JC} 2.5°C/W
 Input Supply Voltage -20V to +60V
 Operating Input Supply Voltage 2V[†] to 26V
 Adjust Input Voltage (Notes 9 and 10)
 -1.5V to +26V
 Shutdown Input Voltage -0.3V to +30V
 Error Comparator Output Voltage -0.3V to +30V

[†] Across the full operating temperature, the minimum input voltage range for full output current is 4.3V to 26V. Output will remain in-regulation at lower output voltages and low current loads down to an input of 2V at 25°C.

Electrical Characteristics

Limits in standard typeface are for $T_J = 25^\circ\text{C}$ and limits in **boldface** apply over the full operating temperature range. Unless otherwise specified, $V_{IN} = V_{OUT} + 1\text{V}$, $I_L = 5\text{mA}$, $C_L = 10\mu\text{F}$. The MIC29372 and MIC29373 are programmed for a 5V output voltage, and $V_{SHUTDOWN} \leq 0.6\text{V}$ (MIC29271-xx and MIC29372 only).

Symbol	Parameter	Conditions	Min	Typical	Max	Units
V_o	Output Voltage Accuracy	Variation from factory trimmed V_{OUT}	-1		1	%
			-2		2	
		$5\text{mA} \leq I_L \leq 500\text{mA}$	-2.5		2.5	
		MIC2937A-12 and 29371-12 only:	-1.5		1.5	
		$5\text{mA} \leq I_L \leq 500\text{mA}$	-3		3	
			-4		4	
$\frac{\Delta V_o}{\Delta T}$	Output Voltage Temperature Coef.	(Note 2) Output voltage > 10V		20 80	100 350	ppm/ $^\circ\text{C}$
$\frac{\Delta V_o}{V_o}$	Line Regulation	$V_{IN} = V_{OUT} + 1\text{V}$ to 26V		0.03	0.10 0.40	%
$\frac{\Delta V_o}{V_o}$	Load Regulation	$I_L = 5$ to 500mA (Note 3)		0.04	0.16 0.30	%
$V_{IN} - V_o$	Dropout Voltage (Note 4)	$I_L = 5\text{mA}$		80	150 180	mV
		$I_L = 100\text{mA}$		200		
		Output voltage > 10V		240		
		$I_L = 500\text{mA}$		300		
		Output voltage > 10V		420		
		$I_L = 750\text{mA}$		370	600 750	
I_{GND}	Ground Pin Current (Note 5)	$I_L = 5\text{mA}$		160	250 300	μA
		$I_L = 100\text{mA}$		1	2.5 3	mA
		$I_L = 500\text{mA}$		8	13 16	
		$I_L = 750\text{mA}$		15	25	
I_{GNDDO}	Ground Pin Current at Dropout (Note 5)	$V_{IN} = 0.5\text{V}$ less than designed V_{OUT} ($V_{OUT} \geq 3.3\text{V}$) $I_o = 5\text{mA}$		200	500	μA
I_{LIMIT}	Current Limit	$V_{OUT} = 0\text{V}$ (Note 6)		1.1	1.5 2	A
$\frac{\Delta V_o}{\Delta P_D}$	Thermal Regulation	(Note 7)		0.05	0.2	%/W
e_n	Output Noise Voltage (10Hz to 100kHz) $I_L = 100\text{mA}$	$C_L = 10\mu\text{F}$		400		$\mu\text{V RMS}$
		$C_L = 100\mu\text{F}$		260		

Electrical Characteristics (Continued)**MIC29372/MIC29373**

Parameter	Conditions				Units
		Min	Typical	Max	
Reference Voltage		1.223 1.210	1.235	1.247 1.260	V V max
Reference Voltage	(Note 8)	1.204		1.266	V
Adjust Pin Bias Current			20	40 60	nA
Reference Voltage Temperature Coefficient	(Note 7)		20		ppm/°C
Adjust Pin Bias Current Temperature Coefficient			0.1		nA/°C

Error Comparator MIC29371/29373

Output Leakage Current	$V_{OH} = 30V$		0.01	1.00 2.00	μA
Output Low Voltage	$V_{IN} = 4.5V$ $I_{OL} = 250\mu A$		150	250 400	mV
Upper Threshold Voltage	(Note 9)	40 25	60		mV
Lower Threshold Voltage	(Note 9)		75	95 140	mV
Hysteresis	(Note 9)		15		mV

Shutdown Input MIC29371/MIC29372

Input Logic Voltage Low (ON)	High (OFF)	2.0	1.3	0.7	V
Shutdown Pin Input Current	$V_{SHUTDOWN} = 2.4V$		30	50 100	μA
	$V_{SHUTDOWN} = 30V$		450	600 750	μA
Regulator Output Current in Shutdown	(Note 10)		3	10 20	μA

Note 1: Absolute maximum ratings indicate limits beyond which damage to the component may occur. Electrical specifications do not apply when operating the device outside of its rated operating conditions. The maximum allowable power dissipation is a function of the maximum junction temperature, $T_{J(MAX)}$, the junction-to-ambient thermal resistance, θ_{JA} , and the ambient temperature, T_A . The maximum allowable power dissipation at any ambient temperature is calculated using: $P_{(MAX)} = (T_{J(MAX)} - T_A) / \theta_{JA}$. Exceeding the maximum allowable power dissipation will result in excessive die temperature, and the regulator will go into thermal shutdown.

Note 2: Output voltage temperature coefficient is defined as the worst case voltage change divided by the total temperature range.

Note 3: Regulation is measured at constant junction temperature using low duty cycle pulse testing. Changes in output voltage due to heating effects are covered by the thermal regulation specification.

Note 4: Dropout Voltage is defined as the input to output differential at which the output voltage drops 100 mV below its nominal value measured at 1V differential. At low values of programmed output voltage, the minimum input supply voltage of 4.3V over temperature must be taken into account. The MIC2937A operates down to 2V of input at reduced output current at 25°C.

Note 5: Ground pin current is the regulator quiescent current. The total current drawn from the source is the sum of the load current plus the ground pin current.

Note 6: The MIC2937A family features fold-back current limiting. The short circuit ($V_{OUT} = 0V$) current limit is less than the maximum current with normal output voltage.

Note 7: Thermal regulation is defined as the change in output voltage at a time T after a change in power dissipation is applied, excluding load or line regulation effects. Specifications are for a 200mA load pulse at $V_{IN} = 20V$ (a 4W pulse) for T = 10ms.

Note 8: $V_{REF} \leq V_{OUT} \leq (V_{IN} - 1V)$, $4.3V \leq V_{IN} \leq 26V$, $5mA < I_L \leq 750mA$, $T_J \leq T_{JMAX}$.

Note 9: Comparator thresholds are expressed in terms of a voltage differential at the Adjust terminal below the nominal reference voltage measured at 6V input (for a 5V regulator). To express these thresholds in terms of output voltage change, multiply by the error amplifier gain $= V_{OUT} / V_{REF} = (R1 + R2) / R2$. For example, at a programmed output voltage of 5V, the Error output is guaranteed to go low when the output drops by $95mV \times 5V / 1.235V = 384mV$. Thresholds remain constant as a percent of VOUT as VOUT is varied, with the dropout warning occurring at typically 5% below nominal, 7.7% guaranteed.

Note 10: Circuit of Figure 3 with $R1 \geq 150k\Omega$. $V_{SHUTDOWN} \geq 2V$ and $V_{IN} \leq 26V$, $V_{OUT} = 0$.

Note 11: When used in dual supply systems where the regulator load is returned to a negative supply, the output voltage must be diode clamped to ground.

Note 12: Maximum positive supply voltage of 60V must be of limited duration (< 100ms) and duty cycle ($\leq 1\%$). The maximum continuous supply voltage is 26V.

Schematic Diagram

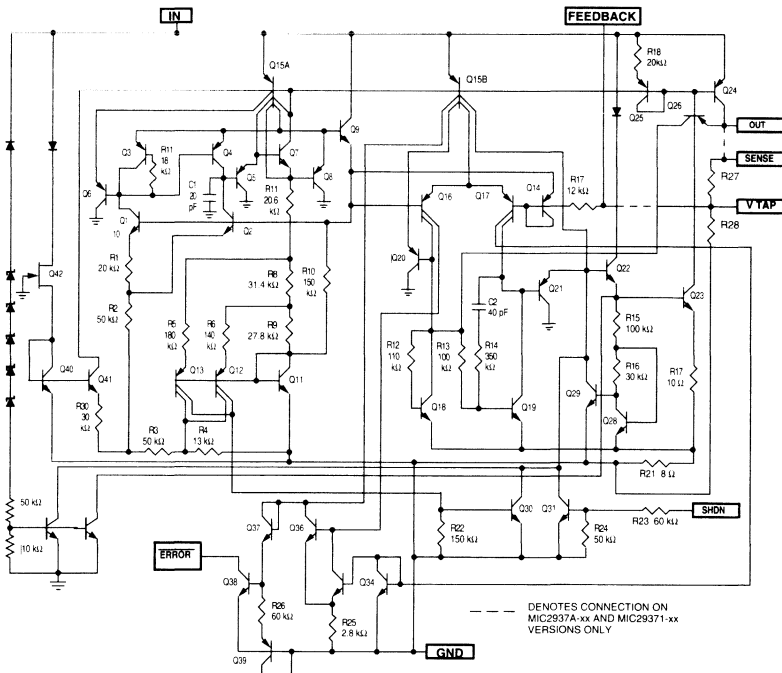

Typical Characteristics

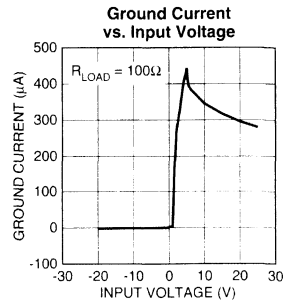
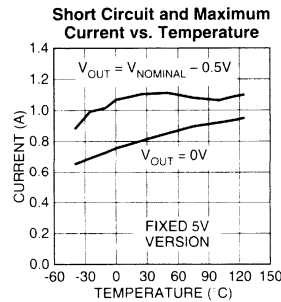
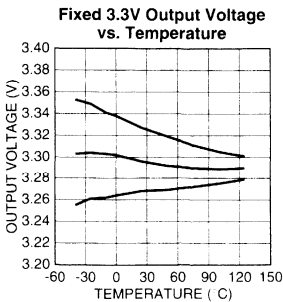
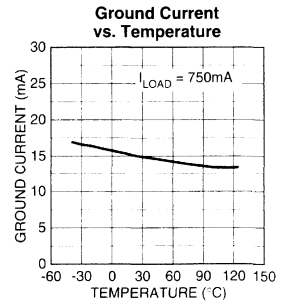
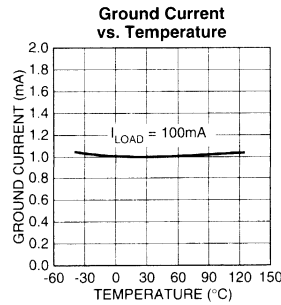
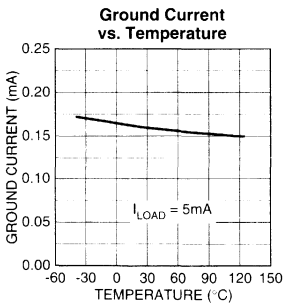
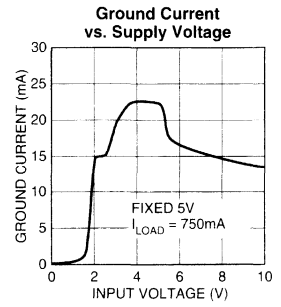
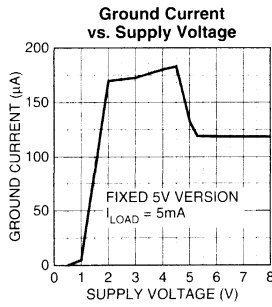
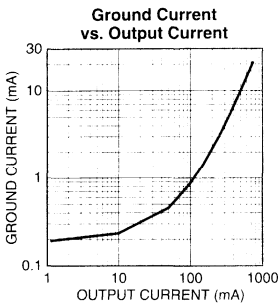
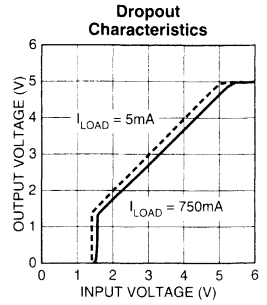
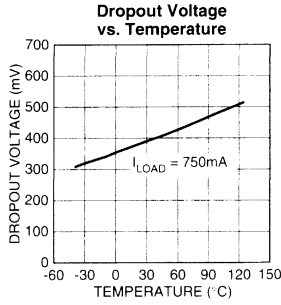
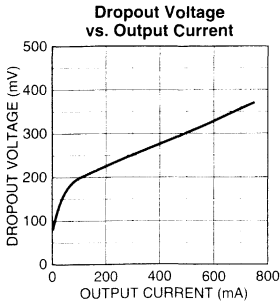

MIC29371/2 Shutdown Current vs. Temperature

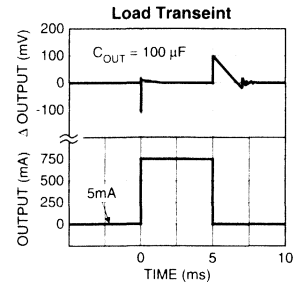
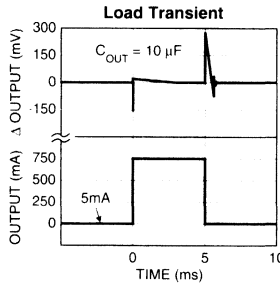
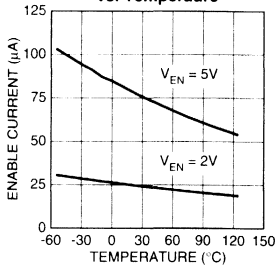

MIC29372/3 Adjust Pin Current vs. Temperature

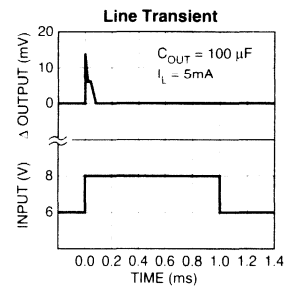
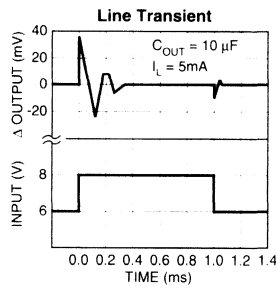
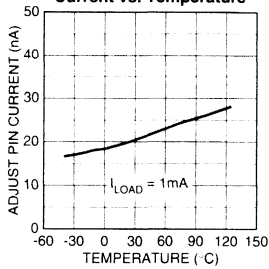

Output Impedance vs. Frequency

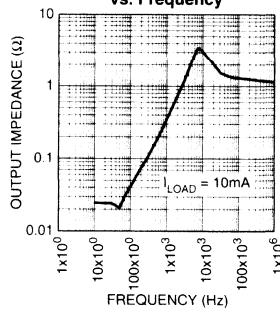

Applications Information

External Capacitors

A 10 μ F (or greater) capacitor is required between the MIC2937A output and ground to prevent oscillations due to instability. Most types of tantalum or aluminum electrolytics will be adequate; film types will work, but are costly and therefore not recommended. Many aluminum electrolytics have electrolytes that freeze at about -30°C , so solid tantalums are recommended for operation below -25°C . The important parameters of the capacitor are an effective series resistance of about 5 Ω or less and a resonant frequency above 500kHz. The value of this capacitor may be increased without limit.

At lower values of output current, less output capacitance is required for output stability. The capacitor can be reduced to 0.5 μ F for current below 10mA or 0.15 μ F for currents below 1 mA. Adjusting the MIC29372/29373 to voltages below 5V runs the error amplifier at lower gains so that more output capacitance is needed. For the worst-case situation of a 750mA load at 1.23V output (Output shorted to Adjust) a 22 μ F (or greater) capacitor should be used.

The MIC2937A/29371 will remain in regulation with a minimum load of 5mA. When setting the output voltage of the MIC29372/29373 version with external resistors, the current through these resistors may be included as a portion of the minimum load.

A 1 μ F capacitor should be placed from the input to ground if there is more than 10 inches of wire between the input and the AC filter capacitor or if a battery is used as the input.

Stray capacitance to the MIC29372/29373 Adjust terminal (pin 7) can cause instability. This may especially be a problem when using high value external resistors to set the output voltage. Adding a 100pF capacitor between Output and Adjust and increasing the output capacitor to at least 22 μ F will remedy this.

Error Detection Comparator Output (MIC29371/ MIC29373)

A logic low output will be produced by the comparator whenever the MIC29371/29373 output falls out of regulation by more than approximately 5%. This figure is the comparator's built-in offset of about 75mV divided by the 1.235V reference voltage. (Refer to the block diagram on Page 1). This trip level remains "5% below normal" regardless of the programmed output voltage of the MIC29371/29373. For example, the error flag trip level is typically 4.75V for a 5V output or 11.4V for a 12V output. The out of regulation condition may be due either to low input voltage, extremely high input voltage, current limiting, or thermal limiting.

Figure 1 is a timing diagram depicting the $\overline{\text{ERROR}}$ signal and the regulated output voltage as the MIC29371/29373 input is ramped up and down. The $\overline{\text{ERROR}}$ signal becomes valid (low)

at about 1.3V input. It goes high at about 5V input (the input voltage at which $V_{\text{OUT}} = 4.75$). Since the MIC29371/29373's dropout voltage is load-dependent (see curve in Typical Performance Characteristics), the input voltage trip point (about 5V) will vary with the load current. The output voltage trip point (approximately 4.75V) does not vary with load.

The error comparator has an NPN open-collector output which requires an external pull-up resistor. Depending on system requirements, this resistor may be returned to the 5V output or some other supply voltage. In determining a value for this resistor, note that while the output is rated to sink 250 μ A, this sink current adds to battery drain in a low battery condition. Suggested values range from 100k to 1M Ω . The resistor is not required if this output is unused.

Programming the Output Voltage (MIC29372/ MIC29373)

The MIC29372/29373 may be programmed for any output voltage between its 1.235V reference and its 26V maximum rating. An external pair of resistors is required, as shown in Figure 3.

The complete equation for the output voltage is

$$V_{\text{OUT}} = V_{\text{REF}} \times \{ 1 + R_1/R_2 \} - |I_{\text{FB}}| R_1$$

where V_{REF} is the nominal 1.235 reference voltage and I_{FB} is the Adjust pin bias current, nominally 20nA. The minimum recommended load current of 1 μ A forces an upper limit of 1.2M Ω on the value of R_2 , if the regulator must work with no load (a condition often found in CMOS in standby), I_{FB} will produce a -2% typical error in V_{OUT} which may be eliminated at room temperature by trimming R_1 . For better accuracy, choosing $R_2 = 100\text{k}$ reduces this error to 0.17% while increasing the resistor program current to 12 μ A. Since the MIC29372/29373 typically draws 100 μ A at no load with SHUTDOWN open-circuited, this is a negligible addition.

Reducing Output Noise

In reference applications it may be advantageous to reduce the AC noise present at the output. One method is to reduce the regulator bandwidth by increasing the size of the output capacitor. This is relatively inefficient, as increasing the capacitor from 1 μ F to 220 μ F only decreases the noise from 430 μ V to 160 μ V_{RMS} for a 100kHz bandwidth at 5V output. Noise can be reduced by a factor of four with the adjustable

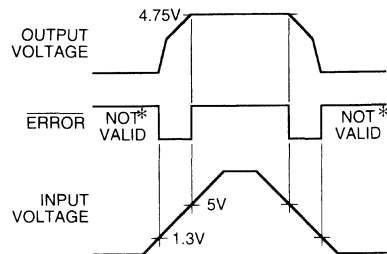

* SEE APPLICATIONS INFORMATION

Figure 1. $\overline{\text{ERROR}}$ Output Timing

regulators with a bypass capacitor across R_1 , since it reduces the high frequency gain from 4 to unity. Pick

$$C_{BYPASS} \cong \frac{1}{2\pi R_1 \cdot 200 \text{ Hz}}$$

or about $0.01\mu\text{F}$. When doing this, the output capacitor must be increased to $10\mu\text{F}$ to maintain stability. These changes reduce the output noise from $430\mu\text{V}$ to $100\mu\text{V}_{\text{RMS}}$ for a 100 kHz bandwidth at 5V output. With the bypass capacitor added, noise no longer scales with output voltage so that improvements are more dramatic at higher output voltages.

Automotive Applications

The MIC2937A is ideally suited for automotive applications for a variety of reasons. It will operate over a wide range of input voltages with very low dropout voltages (40mV at light loads), and very low quiescent currents ($100\mu\text{A}$ typical). These features are necessary for use in battery powered systems, such as automobiles. It is a "bulletproof" device with the ability to survive both reverse battery (negative transients up to 20V below ground), and load dump (positive transients up to 60V) conditions. A wide operating temperature range with low temperature coefficients is yet another reason to use these versatile regulators in automotive designs.

Typical Applications

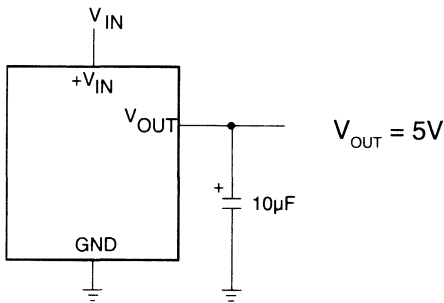
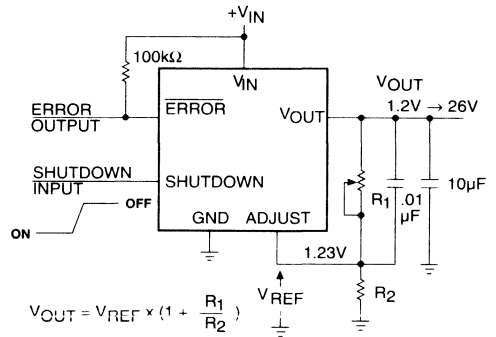
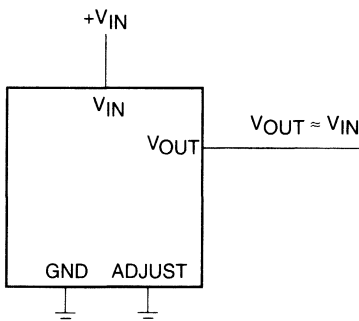

Figure 2. MIC2937A-5.0 Fixed +5V Regulator



ERROR OUTPUT ON MIC29373 ONLY
SHUTDOWN INPUT ON MIC29372 ONLY

Figure 3. MIC29372/29373 Adjustable Regulator



*MINIMUM INPUT-OUTPUT VOLTAGE RANGES FROM 40mV TO 400mV, DEPENDING ON LOAD CURRENT.

Figure 4. MIC29372/29373 Wide Input Voltage Range Current Limiter

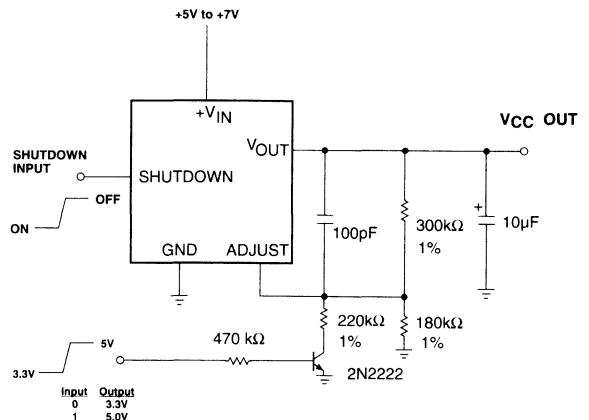

SHUTDOWN PIN LOW= ENABLE OUTPUT. Q1 ON = 3.3V, Q1 OFF = 5.0V.

Figure 5. MIC29372 5.0V or 3.3V Selectable Regulator with Shutdown.

General Description

The MIC2940A and MIC2941A are "bulletproof" efficient voltage regulators with very low dropout voltage (typically 40mV at light loads and 350mV at 1A), and low quiescent current (240 μ A typical). The quiescent current of the MIC2940A increases only slightly in dropout, thus prolonging battery life. Key MIC2940A features include protection against reversed battery, fold-back current limiting, and automotive "load dump" protection (60V positive transient).

The MIC2940 is available in both fixed voltage (3.3V, 5V, and 12V) and adjustable voltage configurations. The MIC2940A-xx devices are three pin fixed voltage regulators. A logic-compatible shutdown input is provided on the adjustable MIC2941A, which enables the regulator to be switched on and off.

Features

- High output voltage accuracy
- Guaranteed 1.25A output
- Low quiescent current
- Low dropout voltage
- Extremely tight load and line regulation
- Very low temperature coefficient
- Current and thermal limiting
- Input can withstand -20V reverse battery and +60V positive transients
- Logic-controlled electronic shutdown
- Output programmable from 1.24V to 26V(MIC2941A)
- Available in TO-220, TO-263, TO-220-5, and TO-263-5 packages.

Applications

- Battery Powered Equipment
- Cellular Telephones
- Laptop, Notebook, and Palmtop Computers
- PCMCIA V_{CC} and V_{PP} Regulation/Switching
- Bar Code Scanners
- Automotive Electronics
- SMPS Post-Regulator/ DC to DC Modules
- Voltage Reference
- High Efficiency Linear Power Supplies

Pin Configuration

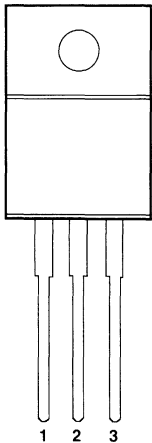

INPUT GROUND OUTPUT
TO-220 Package
(MIC2940A-xxBT)

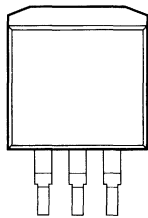

INPUT GROUND OUTPUT
TO-263 Package
(MIC2940A-xxBU)

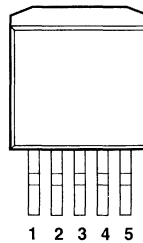

TO-263-5 Package
(MIC2941ABU)

MIC2941A Pinout

- 1) Adjust
- 2) Shutdown
- 3) Ground
- 4) Input
- 5) Output

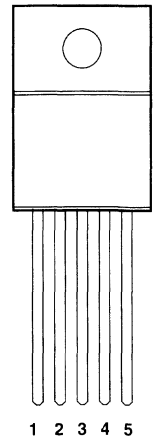

TO-220-5 Package
(MIC2941ABT)

The Tab is Ground on TO-220 and TO-263 packages

Absolute Maximum Ratings
 If Military/Aerospace specified devices are required, contact your local Micrel representative/distributor for availability and specifications.

Power Dissipation (Note 1)	Internally Limited
Lead Temperature (Soldering, 5 seconds)	260°C
Storage Temperature Range	-65°C to +150°C
Operating Junction Temperature Range	-40°C to +125°C
TO-220 θ_{JC}	2°C/W
TO-263 θ_{JC}	2°C/W
Input Supply Voltage	-20V to +60V
Operating Input Supply Voltage	2V ¹ to 26V
Adjust Input Voltage (Notes 9 and 10)	-1.5V to +26V
Shutdown Input Voltage	-0.3V to +30V
Error Comparator Output Voltage	-0.3V to +30V

Ordering Information			
Part Number	Voltage	Temperature Range*	Package
MIC2940A-3.3BT	3.3	-40°C to +125°C	TO-220
MIC2940A-3.3BU	3.3	-40°C to +125°C	TO-263
MIC2940A-5.0BT	5.0	-40°C to +125°C	TO-220
MIC2940A-5.0BU	5.0	-40°C to +125°C	TO-263
MIC2940A-12BT	12	-40°C to +125°C	TO-220
MIC2940A-12BU	12	-40°C to +125°C	TO-263
MIC2941ABT	Adj	-40°C to +125°C	TO-220-5
MIC2941ABU	Adj	-40°C to +125°C	TO-263-5

* Junction temperatures

¹ Across the full operating temperature, the minimum input voltage range for full output current is 4.3V to 26V. Output will remain in-regulation at lower output voltages and low current loads down to an input of 2V at 25°C.

Schematic Diagram

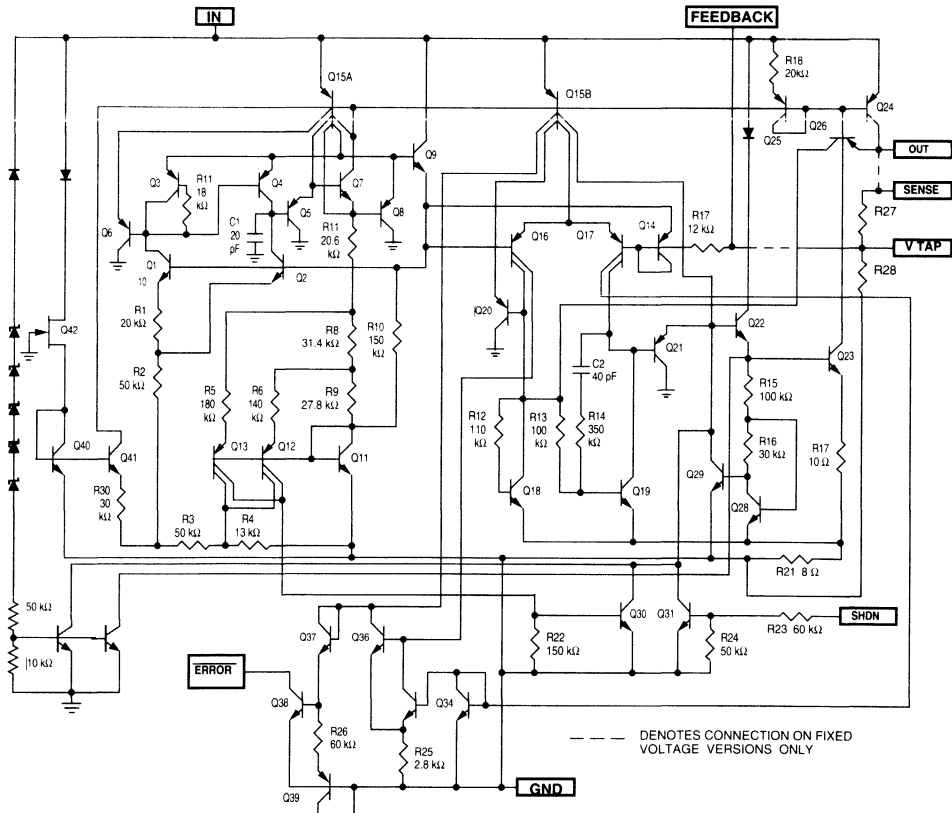

Electrical Characteristics

Limits in standard typeface are for $T_j = 25^\circ\text{C}$ and limits in **boldface** apply over the full operating temperature range. Unless otherwise specified, $V_{IN} = V_{OUT} + 1\text{V}$, $I_L = 1000\text{mA}$, $C_L = 10\mu\text{F}$. The MIC2941A is programmed to output 5V and has $V_{SHUTDOWN} \leq 0.6\text{V}$.

Symbol	Parameter	Conditions	Min	Typical	Max	Units
V_O	Output Voltage Accuracy		-1		1	%
		$5\text{ mA} \leq I_L \leq 1\text{ A}$	-2		2	
$\frac{\Delta V_O}{\Delta T}$	Output Voltage Temperature Coef.	(Note 2)		20	100	ppm/ $^\circ\text{C}$
$\frac{\Delta V_O}{V_O}$	Line Regulation	$V_{IN} = V_{OUT} + 1\text{V}$ to 26V		0.03	0.10 0.40	%
$\frac{\Delta V_O}{V_O}$	Load Regulation	$I_L = 5\text{mA}$ to 1A (Note 3)		0.04	0.16 0.20	%
$V_{IN} - V_O$	Dropout Voltage (Note 4)	$I_L = 5\text{mA}$		60	150 180	mV
		$I_L = 250\text{mA}$		200	250 320	
		$I_L = 1000\text{mA}$		350	450 600	
		$I_L = 1250\text{mA}$		400	600	
I_{GND}	Ground Pin Current (Note 5)	$I_L = 5\text{mA}$		240	350 500	μA
		$I_L = 250\text{mA}$		3	4.5 6	mA
		$I_L = 1000\text{mA}$		22	35 45	
		$I_L = 1250\text{mA}$		35	70	
I_{GNDDO}	Ground Pin Current at Dropout (Note 5)	$V_{IN} = 0.5\text{V}$ less than designed V_{OUT} ($V_{OUT} \geq 3.3\text{V}$) $I_L = 5\text{mA}$		330	600	μA
I_{LIMIT}	Current Limit	$V_{OUT} = 0\text{V}$ (Note 6)		1.6	2.4 3	A
$\frac{\Delta V_O}{\Delta P_D}$	Thermal Regulation	(Note 7)		0.05	0.2	%/W
e_n	Output Noise Voltage (10Hz to 100kHz) $I_L = 100\text{mA}$	$C_L = 10\mu\text{F}$		400		$\mu\text{V RMS}$
		$C_L = 33\mu\text{F}$		260		

Electrical Characteristics (MIC2941A Only)

Parameter	Conditions	Min	Typical	Max	Units
Reference Voltage		1.223 1.210	1.235	1.247 1.260	V V max
Reference Voltage	(Note 8)	1.204		1.266	V
Adjust Pin Bias Current			20	40 60	nA
Reference Voltage Temperature Coefficient			20		ppm/°C
Adjust Pin Bias Current Temperature Coefficient			0.1		nA/°C
Shutdown Input					
Input Logic Voltage	Low (ON) High (OFF)	2.0	1.3	0.7	V
Shutdown Pin Input Current	$V_{\text{SHUTDOWN}} = 2.4\text{V}$		30	50 100	μA
	$V_{\text{SHUTDOWN}} = 26\text{V}$		450	600 750	μA
Regulator Output Current in Shutdown	(Note 10)		3	30 60	μA

Note 1: Absolute maximum ratings indicate limits beyond which damage to the component may occur. Electrical specifications do not apply when operating the device outside of its rated operating conditions. The maximum allowable power dissipation is a function of the maximum junction temperature, $T_{\text{J(MAX)}}$, the junction-to-ambient thermal resistance, θ_{JA} , and the ambient temperature, T_{A} . The maximum allowable power dissipation at any ambient temperature is calculated using: $P_{\text{(MAX)}} = (T_{\text{J(MAX)}} - T_{\text{A}}) / \theta_{\text{JA}}$. Exceeding the maximum allowable power dissipation will result in excessive die temperature, and the regulator will go into thermal shutdown.

Note 2: Output voltage temperature coefficient is defined as the worst case voltage change divided by the total temperature range.

Note 3: Regulation is measured at constant junction temperature using low duty cycle pulse testing. Changes in output voltage due to heating effects are covered by the thermal regulation specification.

Note 4: Dropout Voltage is defined as the input to output differential at which the output voltage drops 100 mV below its nominal value measured at 1V differential. At low values of programmed output voltage, the minimum input supply voltage of 4.3V over temperature must be taken into account.

Note 5: Ground pin current is the regulator quiescent current. The total current drawn from the source is the sum of the load current plus the ground pin current.

Note 6: The MIC2940A features fold-back current limiting. The short circuit ($V_{\text{OUT}} = 0\text{V}$) current limit is less than the maximum current with normal output voltage.

Note 7: Thermal regulation is defined as the change in output voltage at a time T after a change in power dissipation is applied, excluding load or line regulation effects. Specifications are for a 200mA load pulse at $V_{\text{IN}} = 20\text{V}$ (a 4W pulse) for $T = 10\text{ms}$.

Note 8: $V_{\text{REF}} \leq V_{\text{OUT}} \leq (V_{\text{IN}} - 1\text{V})$, $4.3\text{V} \leq V_{\text{IN}} \leq 26\text{V}$, $5\text{mA} < I_{\text{L}} \leq 1.25\text{A}$, $T_{\text{J}} \leq T_{\text{J(MAX)}}$.

Note 9: Circuit of Figure 3 with $R1 \geq 150\text{k}\Omega$. $V_{\text{SHUTDOWN}} \geq 2\text{V}$ and $V_{\text{IN}} \leq 26\text{V}$, $V_{\text{OUT}} = 0$.

Note 10: When used in dual supply systems where the regulator load is returned to a negative supply, the output voltage must be diode clamped to ground.

Note 11: Maximum positive supply voltage of 60 V must be of limited duration (< 100 ms) and duty cycle ($\leq 1\%$). The maximum continuous supply voltage is 26V.

Typical Characteristics

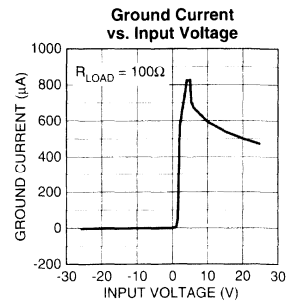
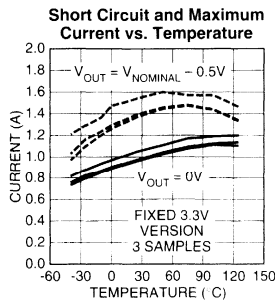
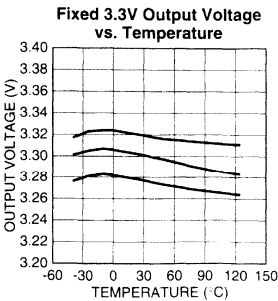
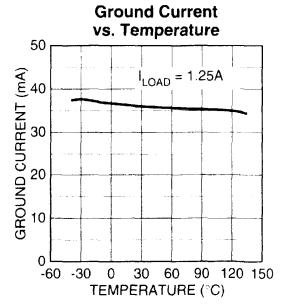
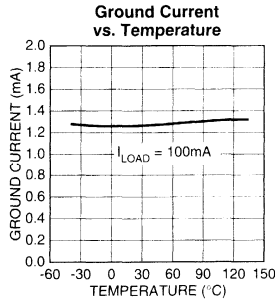
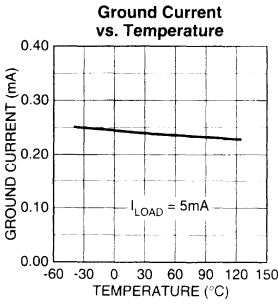
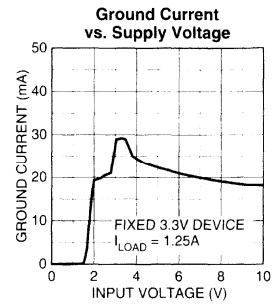
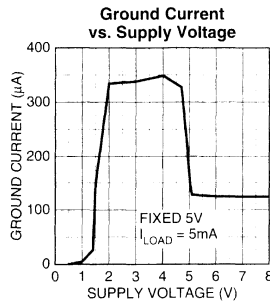
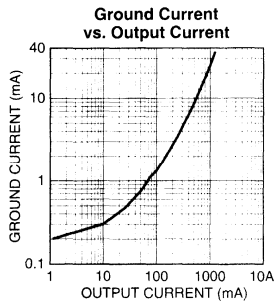
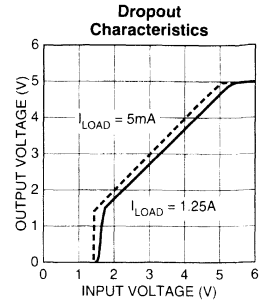
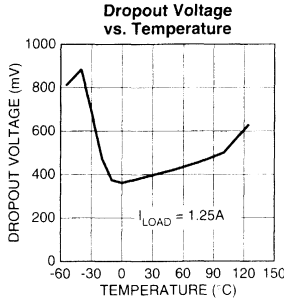
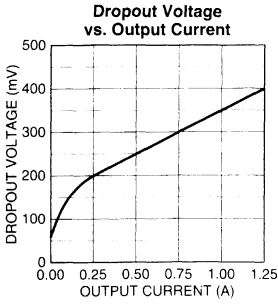

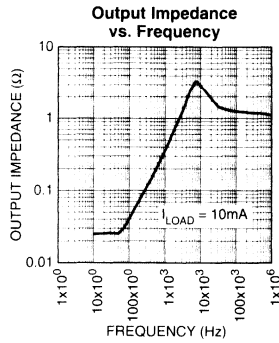
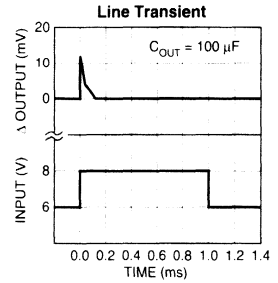
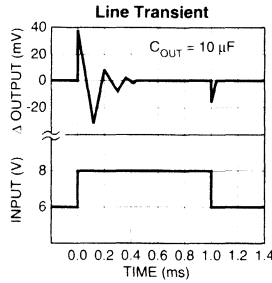
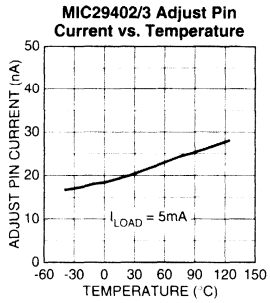
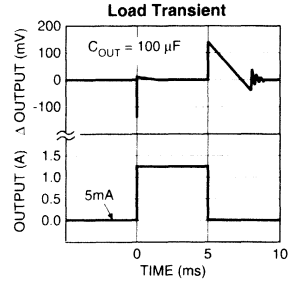
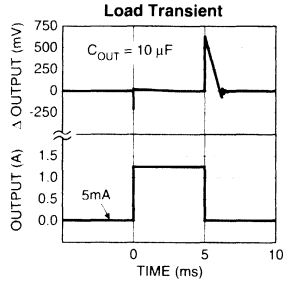
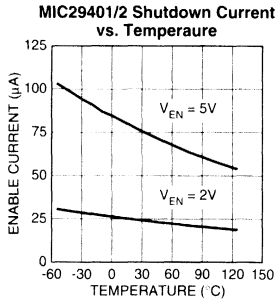

Applications Information

External Capacitors

A 10µF (or greater) capacitor is required between the MIC2940A output and ground to prevent oscillations due to instability. Most types of tantalum or aluminum electrolytics will be adequate; film types will work, but are costly and therefore not recommended. Many aluminum electrolytics have electrolytes that freeze at about -30°C, so solid tantalums are recommended for operation below -25°C. The important parameters of the capacitor are an effective series resistance of about 5Ω or less and a resonant frequency above 500kHz. The value of this capacitor may be increased without limit.

At lower values of output current, less output capacitance is required for output stability. The capacitor can be reduced to 3.3µF for current below 100mA or 2.2µF for currents below 10 mA. Adjusting the MIC2941A to voltages below 5V runs the error amplifier at lower gains so that more output capacitance is needed. For the worst-case situation of a 1.25A load at 1.23V output (Output shorted to Adjust) a 22µF (or greater) capacitor should be used.

The MIC2940A will remain stable and in regulation with load currents ranging from 5mA on up to the full 1.25A rating. The external resistors of the MIC2941A version may be scaled to draw this minimum load current.

A 0.22µF capacitor should be placed from the MIC2940A input to ground if there is more than 10 inches of wire between the input and the AC filter capacitor or if a battery is used as the input.

Stray capacitance to the MIC2941A Adjust terminal can cause instability. This may especially be a problem when using high value external resistors to set the output voltage. Adding a 100pF capacitor between Output and Adjust and increasing the output capacitor to at least 22µF will remedy this.

Programming the Output Voltage (MIC2941A)

The MIC2941A may be programmed for any output voltage between its 1.235V reference and its 26V maximum rating. An external pair of resistors is required, as shown in Figure 3.

The complete equation for the output voltage is

$$V_{OUT} = V_{REF} \times \left\{ 1 + R_1/R_2 \right\} - I_{FB} \cdot R_1$$

where V_{REF} is the nominal 1.235 reference voltage and I_{FB} is the Adjust pin bias current, nominally 20nA. The minimum recommended load current of 1 µA forces an upper limit of 1.2MΩ on the value of R_2 ; if the regulator must work with no load (a condition often found in CMOS in standby), I_{FB} will produce a -2% typical error in V_{OUT} which may be eliminated at room temperature by trimming R_1 . For better accuracy, choosing $R_2 = 100kΩ$ reduces this error to 0.17% while increasing the resistor program current to 12 µA. Since the MIC2941A typically draws 100 µA at no load with SHUTDOWN open-circuited, this is a negligible addition.

Reducing Output Noise

In reference applications it may be advantageous to reduce the AC noise present at the output. One method is to reduce the regulator bandwidth by increasing the size of the output capacitor. This is relatively inefficient, as increasing the capacitor from 1 µF to 220 µF only decreases the noise from 430µV to 160µV_{RMS} for a 100kHz bandwidth at 5V output. Noise can be reduced by a factor of four with the MIC2941A by adding a bypass capacitor across R_1 , since it reduces the high frequency gain from 4 to unity. Pick

$$C_{BYPASS} \cong \frac{1}{2 \pi R_1 \cdot 200 \text{ Hz}}$$

or about 0.01 µF. When doing this, the output capacitor must be increased to 22 µF to maintain stability. These changes reduce the output noise from 430 µV to 100 µV rms for a 100 kHz bandwidth at 5V output. With the bypass capacitor added, noise no longer scales with output voltage so that improvements are more dramatic at higher output voltages.

Automotive Applications

The MIC2940A is ideally suited for automotive applications for a variety of reasons. It will operate over a wide range of input voltages with very low dropout voltages (40mV at light loads), and very low quiescent currents (240µA typical). These features are necessary for use in battery powered systems, such as automobiles. It is a "bulletproof" device with the ability to survive both reverse battery (negative transients up to 20V below ground), and load dump (positive transients up to 60V) conditions. A wide operating temperature range with low temperature coefficients is yet another reason to use these versatile regulators in automotive designs.

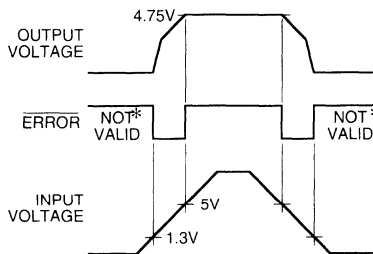

* SEE APPLICATIONS INFORMATION

Figure 1. ERROR Output Timing

Typical Applications

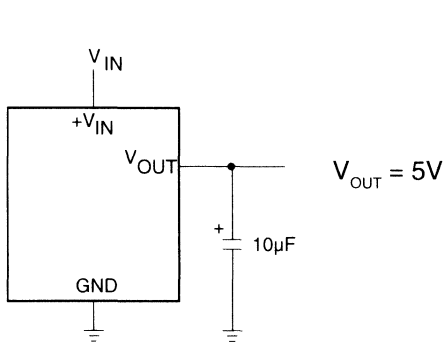

Figure 2. MIC2940A-5.0 Fixed +5V Regulator

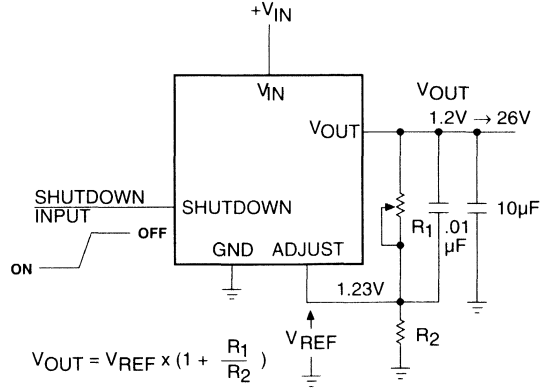
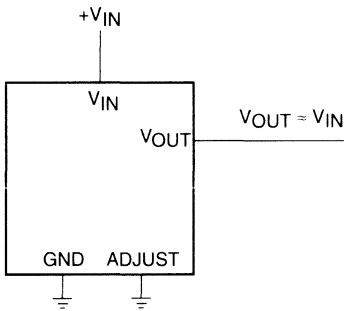
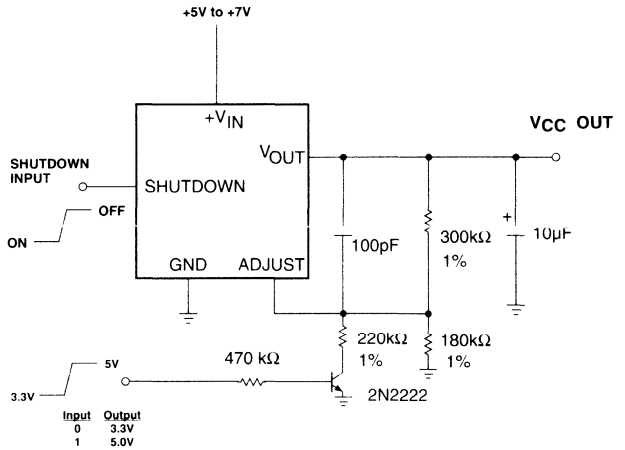

Figure 3. MIC2941A Adjustable Regulator



*MINIMUM INPUT-OUTPUT VOLTAGE RANGES FROM 40mV TO 400mV, DEPENDING ON LOAD CURRENT.

Figure 4. MIC2941A Wide Input Voltage Range Current Limiter



ADJUST PIN LOW= ENABLE OUTPUT. Q1 ON = 3.3V, Q1 OFF = 5.0V.

Figure 5. MIC2941A 5.0V or 3.3V Selectable Regulator with Shutdown.

General Description

The MIC29150/29300/29500/29750 are high current, high accuracy, low-dropout voltage regulators. Using Micrel's proprietary Super Beta PNP™ process with a PNP pass element, these regulators feature 300mV to 370mV (full load) dropout voltages and very low ground current. Designed for high current loads, these devices also find applications in lower current, extremely low dropout-critical systems, where their tiny dropout voltage and ground current values are important attributes.

The MIC29150/29300/29500/29750 are fully protected against overcurrent faults, reversed input polarity, reversed lead insertion, overtemperature operation, and positive and negative transient voltage spikes. Five pin fixed voltage versions feature logic level ON/OFF control and an error flag which signals whenever the output falls out of regulation. Flagged states include low input voltage (dropout), output current limit, overtemperature shutdown, and extremely high voltage spikes on the input.

On the MIC29xx1 and MIC29xx2, the ENABLE pin may be tied to V_{IN} if it is not required for ON/OFF control. The MIC29150/29300/29500 are available in 3- and 5-pin TO-220 and surface mount TO-263 packages. The MIC29750 7.5A regulators are available in 3- and 5-pin TO-247 packages.

Features

- High Current Capability
 - MIC29150/29151/29152/29153 1.5A
 - MIC29300/29301/29302/29303 3A
 - MIC29500/29501/29502/29503 5A
 - MIC29750/29751/29752 7.5A
- Low-Dropout Voltage 350mV at Full Load
- Low Ground Current
- Accurate 1% Guaranteed Tolerance
- Extremely Fast Transient Response
- Reverse-battery and "Load Dump" Protection
- Zero-Current Shutdown Mode (5-Pin versions)
- Error Flag Signals Output Out-of-Regulation (5-Pin versions)
- Also Characterized For Smaller Loads With Industry-Leading Performance Specifications
- Fixed Voltage and Adjustable Versions

Applications

- Battery Powered Equipment
- High-Efficiency "Green" Computer Systems
- Automotive Electronics
- High-Efficiency Linear Power Supplies
- High-Efficiency Post-Regulator For Switching Supply

Pin Configuration

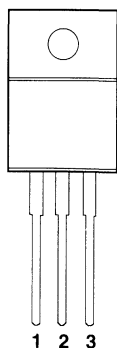

MIC29150/29300/
29500BT and
MIC29750BWT

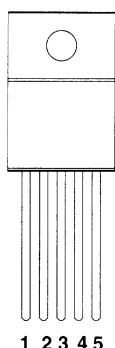

MIC29151/29152/29153BT
MIC29301/29302/29303BT
MIC29501/29502/29503BT
MIC29751/29752BWT

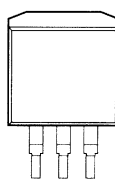

MIC29150/29300BU

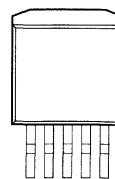

MIC29151/29152/29153BU
MIC29301/29302/29303BU

Pinout On all devices, the Tab is grounded.

MIC29150/29300/29500/29750 Three Terminal Devices:

Pin 1 = Input, 2 = Ground, 3 = Output

MIC29151/29301/29501/29751 Five Terminal Fixed Voltage Devices:

Pin 1 = Enable, 2 = Input, 3 = Ground, 4 = Output, 5 = Flag

MIC29152/29302/29502/29752 Adjustable with ON/OFF Control

Pin 1 = Enable, 2 = Input, 3 = Ground, 4 = Output, 5 = Adjust

MIC29153/29303/29503 Adjustable with Flag

Pin 1 = Flag, 2 = Input, 3 = Ground, 4 = Output, 5 = Adjust

Ordering Information

Part Number	Temp. Range*	Volts	Current	Package
MIC29150-3.3BT	-40 to +125°C	3.3	1.5A	TO-220
MIC29150-5.0BT	-40 to +125°C	5.0	1.5A	TO-220
MIC29150-12BT	-40 to +125°C	12	1.5A	TO-220
MIC29150-3.3BU	-40 to +125°C	3.3	1.5A	TO-263
MIC29150-5.0BU	-40 to +125°C	5.0	1.5A	TO-263
MIC29150-12BU	-40 to +125°C	12	1.5A	TO-263
MIC29151-3.3BT	-40 to +125°C	3.3	1.5A	TO-220-5
MIC29151-5.0BT	-40 to +125°C	5.0	1.5A	TO-220-5
MIC29151-12BT	-40 to +125°C	12	1.5A	TO-220-5
MIC29151-3.3BU	-40 to +125°C	3.3	1.5A	TO-263-5
MIC29151-5.0BU	-40 to +125°C	5.0	1.5A	TO-263-5
MIC29151-12BU	-40 to +125°C	12	1.5A	TO-263-5
MIC29152BT	-40 to +125°C	Adj	1.5A	TO-220-5
MIC29152BU	-40 to +125°C	Adj	1.5A	TO-263-5
MIC29153BT	-40 to +125°C	Adj	1.5A	TO-220-5
MIC29153BU	-40 to +125°C	Adj	1.5A	TO-263-5
MIC29300-3.3BT	-40 to +125°C	3.3	3.0A	TO-220
MIC29300-5.0BT	-40 to +125°C	5.0	3.0A	TO-220
MIC29300-12BT	-40 to +125°C	12	3.0A	TO-220
MIC29300-3.3BU	-40 to +125°C	3.3	3.0A	TO-263
MIC29300-5.0BU	-40 to +125°C	5.0	3.0A	TO-263
MIC29300-12BU	-40 to +125°C	12	3.0A	TO-263
MIC29301-3.3BT	-40 to +125°C	3.3	3.0A	TO-220-5
MIC29301-5.0BT	-40 to +125°C	5.0	3.0A	TO-220-5
MIC29301-12BT	-40 to +125°C	12	3.0A	TO-220-5
MIC29301-3.3BU	-40 to +125°C	3.3	3.0A	TO-263-5
MIC29301-5.0BU	-40 to +125°C	5.0	3.0A	TO-263-5
MIC29301-12BU	-40 to +125°C	12	3.0A	TO-263-5
MIC29302BT	-40 to +125°C	Adj	3.0A	TO-220-5
MIC29302BU	-40 to +125°C	Adj	3.0A	TO-263-5
MIC29303BT	-40 to +125°C	Adj	3.0A	TO-220-5
MIC29303BU	-40 to +125°C	Adj	3.0A	TO-263-5

Part Number	Temp. Range*	Volts	Current	Package
MIC29500-3.3BT	-40 to +125°C	3.3	5.0A	TO-220
MIC29500-5.0BT	-40 to +125°C	5.0	5.0A	TO-220
MIC29501-3.3BT	-40 to +125°C	3.3	5.0A	TO-220-5
MIC29501-5.0BT	-40 to +125°C	5.0	5.0A	TO-220-5
MIC29501-3.3BU	-40 to +125°C	3.3	5.0A	TO-263-5
MIC29501-5.0BU	-40 to +125°C	5.0	5.0A	TO-263-5
MIC29502BT	-40 to +125°C	Adj	5.0A	TO-220-5
MIC29502BU	-40 to +125°C	Adj	5.0A	TO-263-5
MIC29503BT	-40 to +125°C	Adj	5.0A	TO-220-5
MIC29503BU	-40 to +125°C	Adj	5.0A	TO-263-5
MIC29750-3.3BWT	-40 to +125°C	3.3	7.5A	TO-247-3
MIC29750-5.0BWT	-40 to +125°C	5.0	7.5A	TO-247-3
MIC29751-3.3BWT	-40 to +125°C	3.3	7.5A	TO-247-5
MIC29751-5.0BWT	-40 to +125°C	5.0	7.5A	TO-247-5
MIC29752BWT	-40 to +125°C	Adj	7.5A	TO-247-5

* Junction Temperature

MIC29xx0 versions are 3-terminal fixed voltage devices. MIC29xx1 are fixed voltage devices with ENABLE and ERROR flag. MIC29xx2 are adjustable regulators with ENABLE control. MIC29xx3 are adjustables with an ERROR flag.

Absolute Maximum Ratings

Power Dissipation	Internally Limited
Lead Temperature (Soldering, 5 seconds)	260°C
Storage Temperature Range	-65°C to +150°C
Input Supply Voltage (Note 1)	-20V to +60V

Operating Ratings

Operating Junction Temperature	-40°C to +125°C
Maximum Operating Input Voltage	26V
TO-220 θ_{JC}	2°C/W
TO-263 θ_{JC}	2°C/W
TO-247 θ_{JC}	1.5°C/W

Electrical Characteristics

All measurements at $T_J = 25^\circ\text{C}$ unless otherwise noted. **Bold** values are guaranteed across the operating temperature range. Adjustable versions are programmed to 5.0V.

Parameter	Condition	Min	Typ	Max	Units	
Output Voltage	$I_O = 10\text{mA}$	-1		1	%	
	$10\text{mA} \leq I_O \leq I_{FL}, (V_{OUT} + 1\text{V}) \leq V_{IN} \leq 26\text{V}$ (Note 2)	-2		2	%	
Line Regulation	$I_O = 10\text{mA}, (V_{OUT} + 1\text{V}) \leq V_{IN} \leq 26\text{V}$		0.06	0.5	%	
Load Regulation	$V_{IN} = V_{OUT} + 5\text{V}, 10\text{mA} \leq I_{OUT} \leq I_{FULL\ LOAD}$ (Note 2, 6)		0.2	1	%	
$\frac{\Delta V_O}{\Delta T}$	Output Voltage (Note 6) Temperature Coef.		20	100	ppm/°C	
Dropout Voltage	$\Delta V_{OUT} = -1\%$, (Note 3) MIC29150	$I_O = 100\text{mA}$	80	200	mV	
		$I_O = 750\text{mA}$	220			
	MIC29300	$I_O = 1.5\text{A}$	350	600		
		$I_O = 100\text{mA}$	80	175		
	MIC29500	$I_O = 1.5\text{A}$	250			
		$I_O = 3\text{A}$	370	600		
		$I_O = 250\text{mA}$	125	250		
	MIC29750	$I_O = 2.5\text{A}$	250			
		$I_O = 5\text{A}$	370	600		
		$I_O = 250\text{mA}$	80	200		
			$I_O = 4\text{A}$	270		
			$I_O = 7.5\text{A}$	425		600
Ground Current	MIC29150	$I_O = 750\text{mA}, V_{IN} = V_{OUT} + 1\text{V}$	8	20	mA	
		$I_O = 1.5\text{A}$	22			
	MIC29300	$I_O = 1.5\text{A}, V_{IN} = V_{OUT} + 1\text{V}$	10	35	mA	
		$I_O = 3\text{A}$	37			
	MIC29500	$I_O = 2.5\text{A}, V_{IN} = V_{OUT} + 1\text{V}$	15	50	mA	
		$I_O = 5\text{A}$	70			
	MIC29750	$I_O = 4\text{A}, V_{IN} = V_{OUT} + 1\text{V}$	35	75	mA	
		$I_O = 7.5\text{A}$	120			
I_{GNDPO} Ground Pin Current at Dropout	$V_{IN} = 0.5\text{V}$ less than specified V_{OUT} . $I_{OUT} = 10\text{mA}$	MIC29150	0.9		mA	
		MIC29300	1.7		mA	
		MIC29500	2.1		mA	
		MIC29750	3.1		mA	
Current Limit	$V_{OUT} = 0\text{V}$ (Note 4)	MIC29150	2.1	3.5	A	
		MIC29300	4.5	5.0	A	
		MIC29500	7.5	10.0	A	
		MIC29750	9.5	15	A	
e_n , Output Noise Voltage (10Hz to 100kHz) $I_L = 100\text{mA}$	$C_L = 10\mu\text{F}$		400		$\mu\text{V RMS}$	
	$C_L = 33\mu\text{F}$		260			

Electrical Characteristics (Continued)**Reference MIC29xx2/MIC29xx3**

Parameter	Conditions	Min	Typical	Max	Units
Reference Voltage		1.228 1.215	1.240	1.252 1.265	V V _{max}
Reference Voltage	(Note 8)	1.203		1.277	V
Adjust Pin Bias Current			40	80 120	nA
Reference Voltage Temperature Coefficient	(Note 7)		20		ppm/°C
Adjust Pin Bias Current Temperature Coefficient			0.1		nA/°C

Flag Output (Error Comparator) MIC29xx1/29xx3

Output Leakage Current	$V_{OH} = 26V$		0.01	1.00 2.00	μA
Output Low Voltage	Device set for 5V. $V_{IN} = 4.5V$ $I_{OL} = 250\mu A$		220	300 400	mV
Upper Threshold Voltage	Device set for 5V (Note 9)	40 25	60		mV
Lower Threshold Voltage	Device set for 5V (Note 9)		75	95 140	mV
Hysteresis	Device set for 5V (Note 9)		15		mV

ENABLE Input MIC29xx1/MIC29xx2

Input Logic Voltage Low (OFF) High (ON)		2.4		0.8	V
Enable Pin Input Current	$V_{EN} = 26V$		100	600 750	μA
	$V_{EN} = 0.8V$			1 2	μA
Regulator Output Current in Shutdown	(Note 10)		10	500	μA

Notes

- Note 1:** Maximum positive supply voltage of 60V must be of limited duration (<100msec) and duty cycle ($\leq 1\%$). The maximum continuous supply voltage is 26V.
- Note 2:** Full Load current (I_{FL}) is defined as 1.5A for the MIC29150, 3A for the MIC29300, 5A for the MIC29500, and 7.5A for the MIC29750 families.
- Note 3:** Dropout voltage is defined as the input-to-output differential when the output voltage drops to 99% of its nominal value with $V_{OUT} + 1V$ applied to V_{IN} .
- Note 4:** $V_{IN} = V_{OUT(nominal)} + 1V$. For example, use $V_{IN} = 4.3V$ for a 3.3V regulator or use 6V for a 5V regulator. Employ pulse-testing procedures to minimize temperature rise.
- Note 5:** Ground pin current is the regulator quiescent current. The total current drawn from the source is the sum of the load current plus the ground pin current.
- Note 6:** Output voltage temperature coefficient is defined as the worst case voltage change divided by the total temperature range.
- Note 7:** Thermal regulation is defined as the change in output voltage at a time T after a change in power dissipation is applied, excluding load or line regulation effects. Specifications are for a 200mA load pulse at $V_{IN} = 20V$ (a 4W pulse) for $T = 10ms$.
- Note 8:** $V_{REF} \leq V_{OUT} \leq (V_{IN} - 1V)$, $2.3V \leq V_{IN} \leq 26V$, $10mA < I_L \leq I_{FL}$, $T_J \leq T_{JMAX}$.
- Note 9:** Comparator thresholds are expressed in terms of a voltage differential at the Adjust terminal below the nominal reference voltage measured at 6V input. To express these thresholds in terms of output voltage change, multiply by the error amplifier gain = $V_{OUT} / V_{REF} = (R1 + R2) / R2$. For example, at a programmed output voltage of 5V, the Error output is guaranteed to go low when the output drops by $95mV \times 5V / 1.240V = 384mV$. Thresholds remain constant as a percent of V_{OUT} as V_{OUT} is varied, with the dropout warning occurring at typically 5% below nominal, 7.7% guaranteed.
- Note 10:** $V_{EN} \leq 0.8V$ and $V_{IN} \leq 26V$, $V_{OUT} = 0$.
- Note 11:** When used in dual supply systems where the regulator load is returned to a negative supply, the output voltage must be diode clamped to ground.

Block Diagram

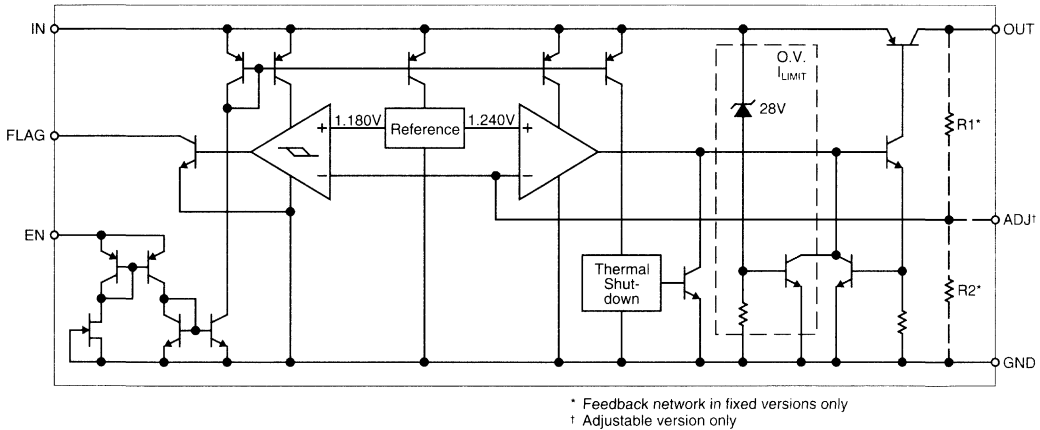

Typical Applications

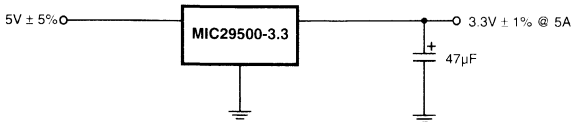

Figure 1. Fixed output voltage.

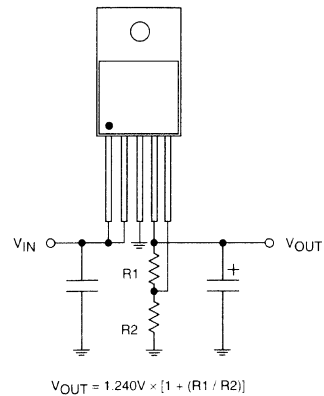
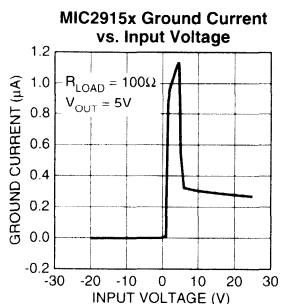
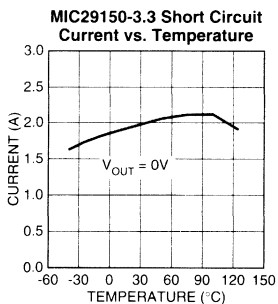
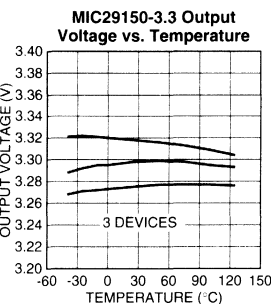
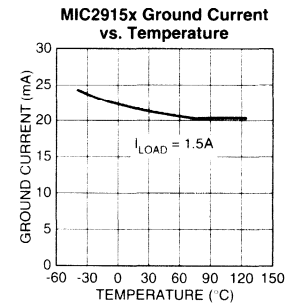
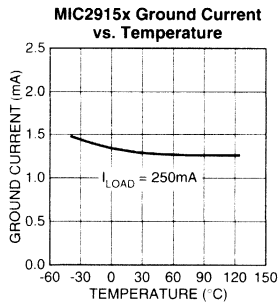
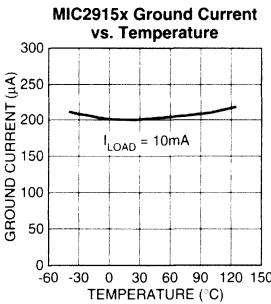
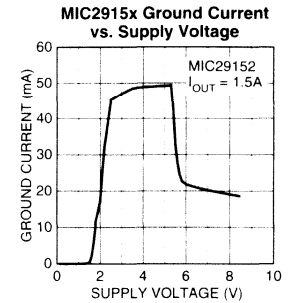
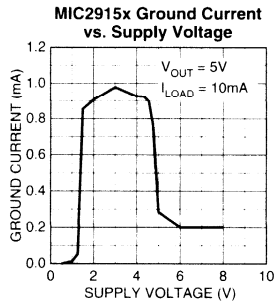
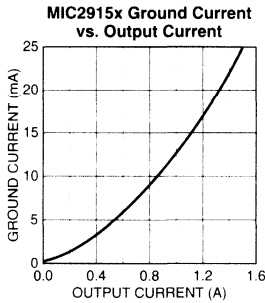
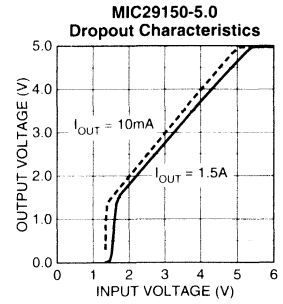
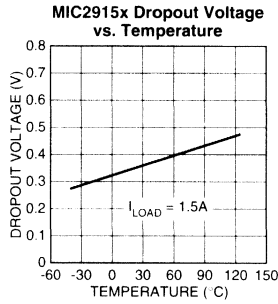
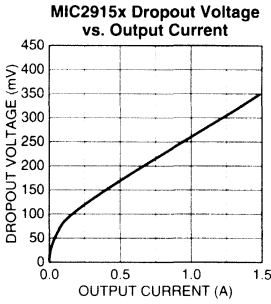
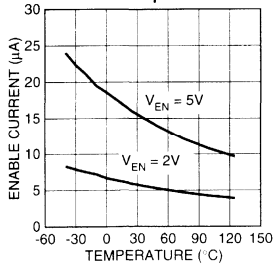

Figure 2. Adjustable output voltage configuration. For best results, the total series resistance should be small enough to pass the minimum regulator load current.

Typical Characteristics MIC2915x



MIC29151-xx/2 Enable Current vs. Temperature



MIC2915x Load Transient

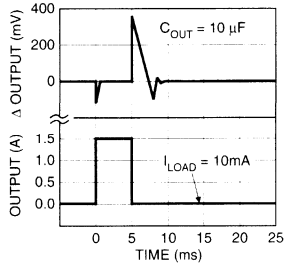

MIC2915x Load Transient

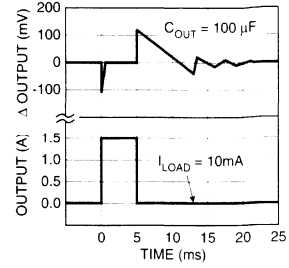

MIC29152/3 Adjust Pin Current vs. Temperature

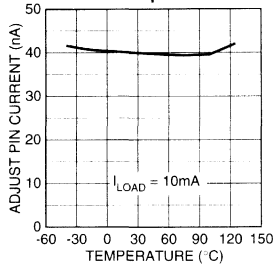

MIC2915x Line Transient

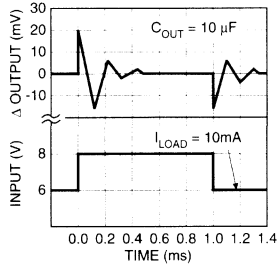

MIC2915x Line Transient

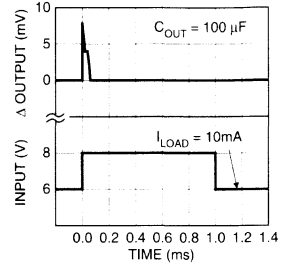

MIC2915x Output Impedance vs. Frequency

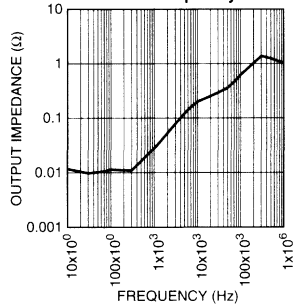

Typical Characteristics MIC2930x

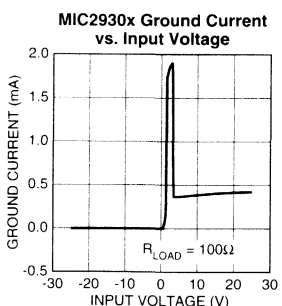
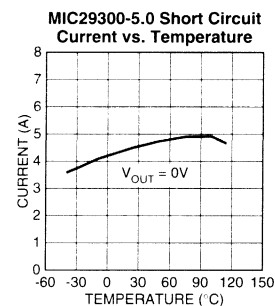
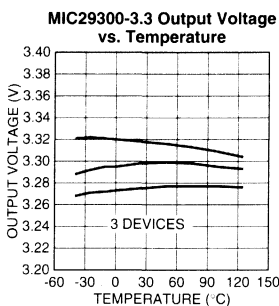
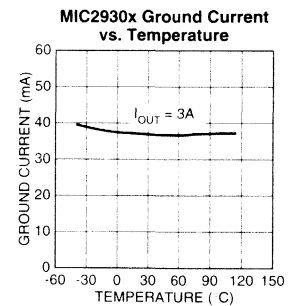
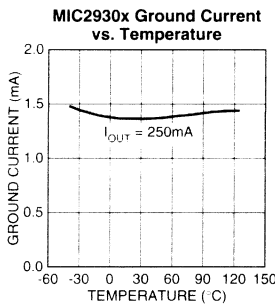
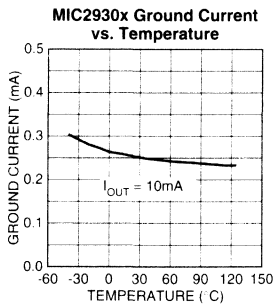
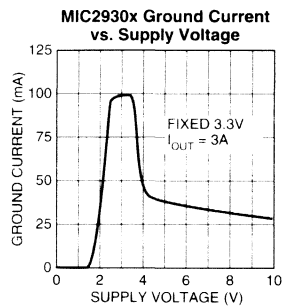
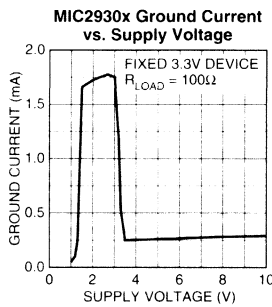
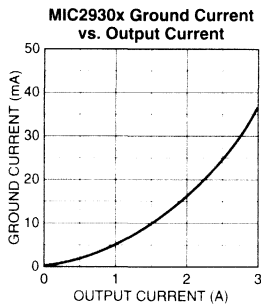
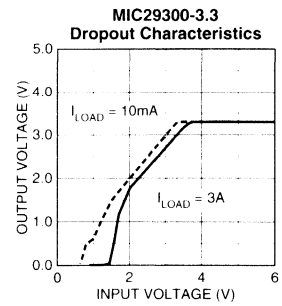
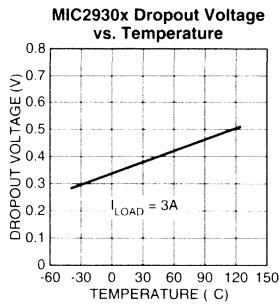
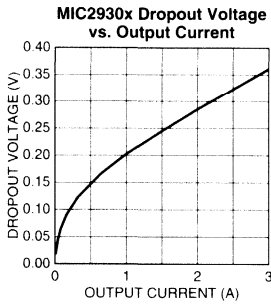

MIC29301-x/2 Enable Current vs. Temperature

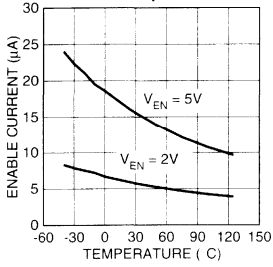

MIC2930x Load Transient

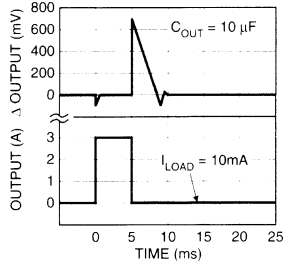

MIC2930x Load Transient

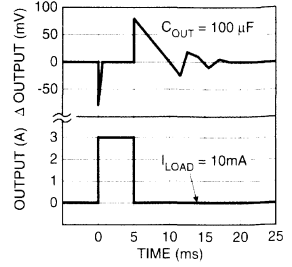

MIC29302/3 Adjust Pin Current vs. Temperature

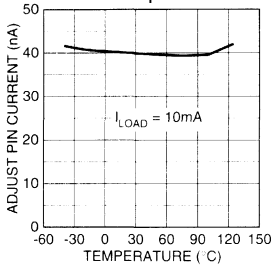

MIC2930x Line Transient

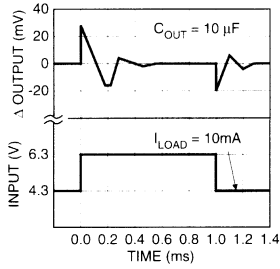

MIC2930x Line Transient

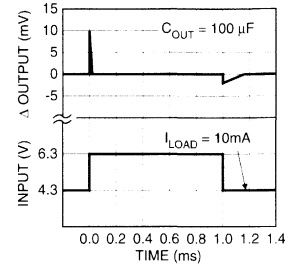

MIC2930x Output Impedance vs. Frequency

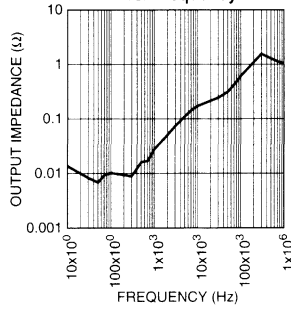

Typical Characteristics MIC2950x

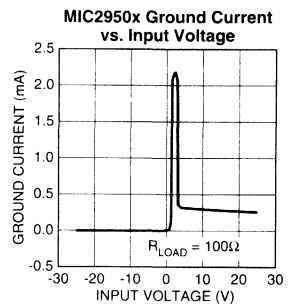
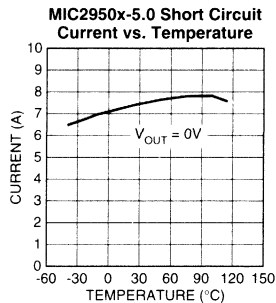
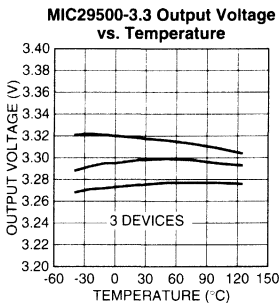
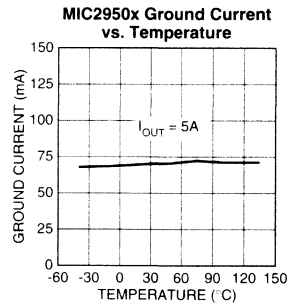
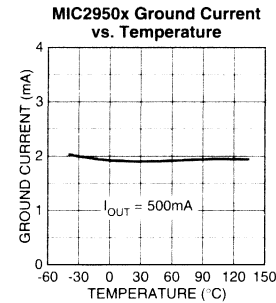
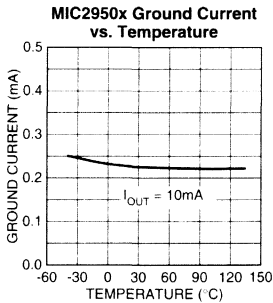
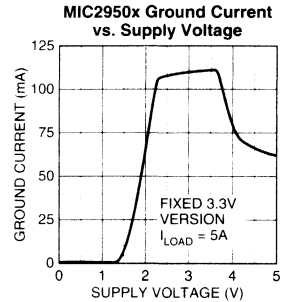
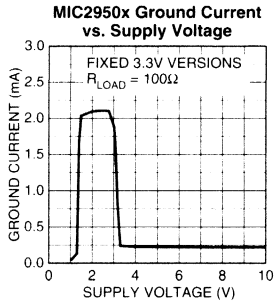
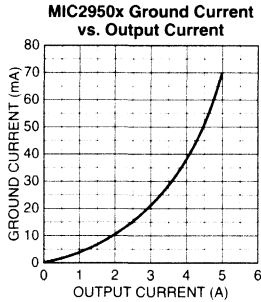
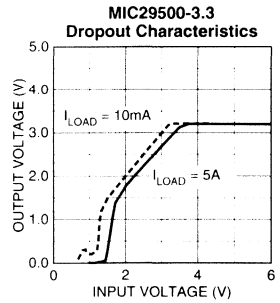
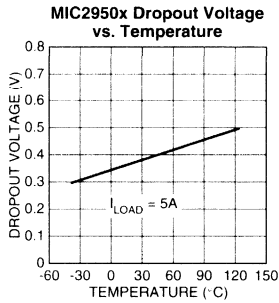
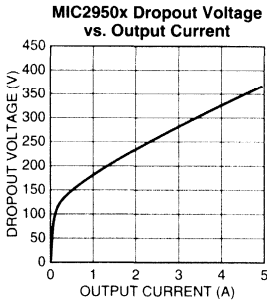

MIC29501-xx/2 Enable Current vs. Temperature

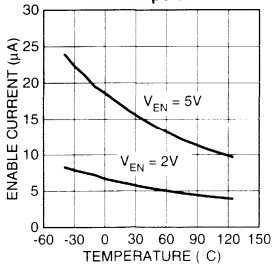

MIC2950x Load Transient

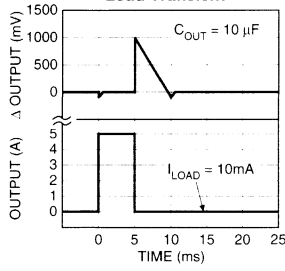

MIC2950x Load Transient

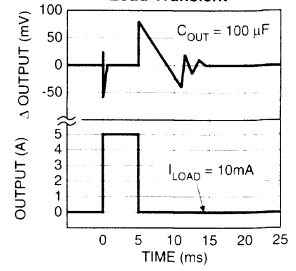

MIC29502/3 Adjust Pin Current vs. Temperature

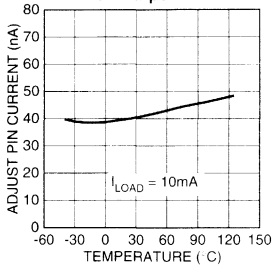

MIC2950x Line Transient

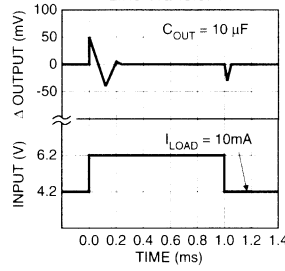

MIC2950x Line Transient

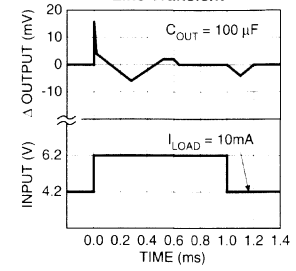

MIC2950x Output Impedance vs. Frequency

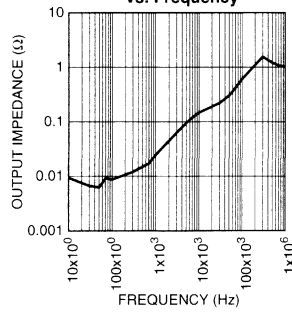

Typical Characteristics MIC2975x

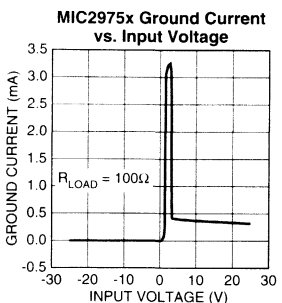
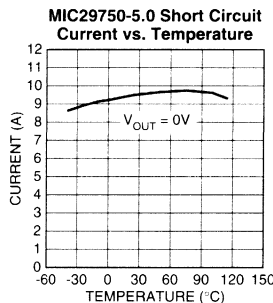
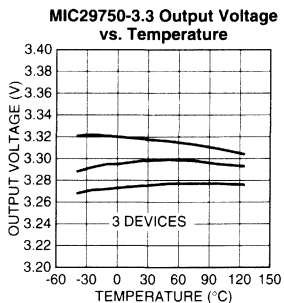
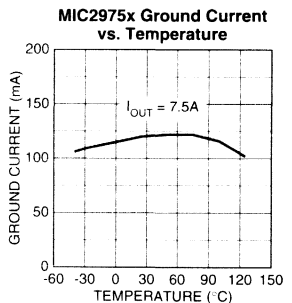
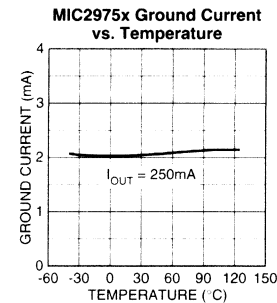
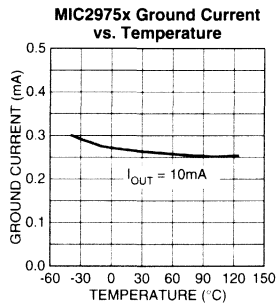
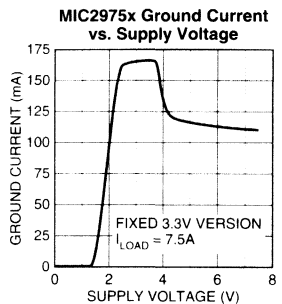
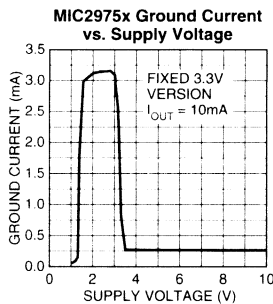
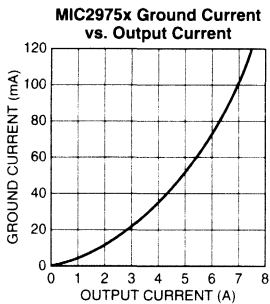
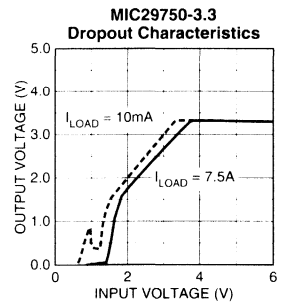
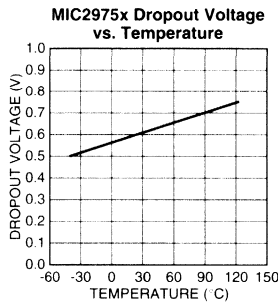
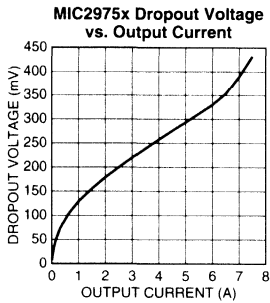

MIC29751-xx/2 Enable Current vs. Temperature

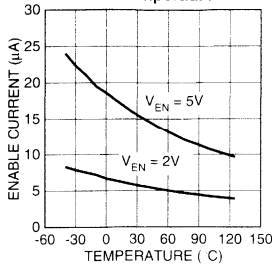

MIC2975x Load Transient

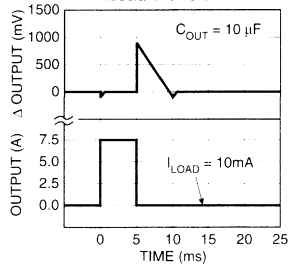

MIC2975x Load Transient

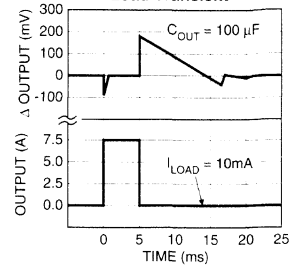

MIC29752/3 Adjust Pin Current vs. Temperature

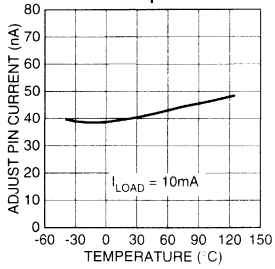

MIC2975x Line Transient

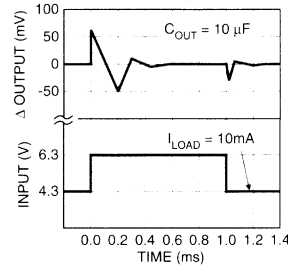

MIC2975x Line Transient

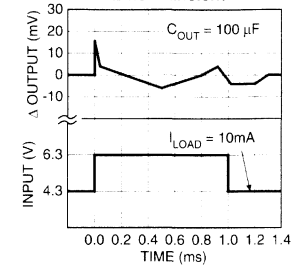

MIC2975x Output Impedance vs. Frequency

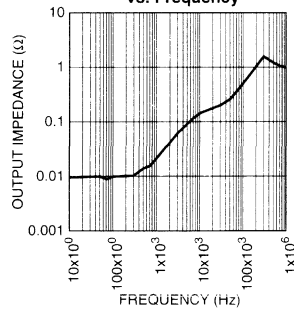

Applications Information

The MIC29150/29300/29500/29750 are high performance low-dropout voltage regulators suitable for all moderate to high-current voltage regulator applications. Their 300mV to 400mV dropout voltage at full load make them especially valuable in battery powered systems and as high efficiency noise filters in “post-regulator” applications. Unlike older NPN-pass transistor designs, where the minimum dropout voltage is limited by the base-emitter voltage drop and collector-emitter saturation voltage, dropout performance of the PNP output of these devices is limited merely by the low V_{CE} saturation voltage.

A trade-off for the low dropout voltage is a varying base drive requirement. But Micrel's Super Beta PNP™ process reduces this drive requirement to merely 1% of the load current.

The MIC29150–29750 family of regulators is fully protected from damage due to fault conditions. Current limiting is provided. This limiting is linear; output current under overload conditions is constant. Thermal shutdown disables the device when the die temperature exceeds the 125°C maximum safe operating temperature. Transient protection allows device (and load) survival even when the input voltage spikes between –20V and +60V. When the input voltage exceeds about 35V to 40V, the overvoltage sensor temporarily disables the regulator. The output structure of these regulators allows voltages in excess of the desired output voltage to be applied without reverse current flow. MIC29xx1 and MIC29xx2 versions offer a logic level ON/OFF control: when disabled, the devices draw nearly zero current.

An additional feature of this regulator family is a common pinout: a design's current requirement may change up or down yet use the same board layout, as all of these regulators have identical pinouts.

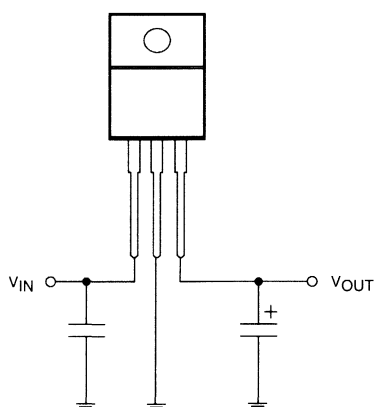

Figure 3. Linear regulators require only two capacitors for operation.

Thermal Design

Linear regulators are simple to use. The most complicated design parameters to consider are thermal characteristics. Thermal design requires the following application-specific parameters:

- Maximum ambient temperature, T_A
- Output Current, I_{OUT}
- Output Voltage, V_{OUT}
- Input Voltage, V_{IN}

First, we calculate the power dissipation of the regulator from these numbers and the device parameters from this datasheet.

$$P_D = I_{OUT} \times (1.01V_{IN} - V_{OUT})$$

Where the ground current is approximated by 1% of I_{OUT} . Then the heat sink thermal resistance is determined with this formula:

$$\theta_{SA} = \frac{T_{J\ MAX} - T_A}{P_D} - (\theta_{JC} + \theta_{CS})$$

Where $T_{J\ MAX} \leq 125^\circ\text{C}$ and θ_{CS} is between 0 and $2^\circ\text{C}/\text{W}$.

The heat sink may be significantly reduced in applications where the minimum input voltage is known and is large compared with the dropout voltage. Use a series input resistor to drop excessive voltage and distribute the heat between this resistor and the regulator. The low dropout properties of Micrel Super Beta PNP regulators allow very significant reductions in regulator power dissipation and the associated heat sink without compromising performance. When this technique is employed, a capacitor of at least 0.1 μF is needed directly between the input and regulator ground.

Please refer to Application Note 9 and Application Hint 17 for further details and examples on thermal design and heat sink specification.

Capacitor Requirements

For stability and minimum output noise, a capacitor on the regulator output is necessary. The value of this capacitor is dependent upon the output current; lower currents allow smaller capacitors. MIC29150–29750 regulators are stable with the following minimum capacitor values at full load:

Device	Full Load Capacitor
MIC29150	10 μF
MIC29300	10 μF
MIC29500	10 μF
MIC29750	22 μF

This capacitor need not be an expensive low ESR type: aluminum electrolytics are adequate. In fact, extremely low ESR capacitors may contribute to instability. Tantalum capacitors are recommended for systems where fast load transient response is important.

Where the regulator is powered from a source with a high AC impedance, a 0.1µF capacitor connected between Input and GND is recommended. This capacitor should have good characteristics to above 250kHz.

Minimum Load Current

The MIC29150–29750 regulators are specified between finite loads. If the output current is too small, leakage currents dominate and the output voltage rises. The following minimum load current swamps any expected leakage current across the operating temperature range:

Device	Minimum Load
MIC29150	5mA
MIC29300	7mA
MIC29500	10mA
MIC29750	10mA

Adjustable Regulator Design

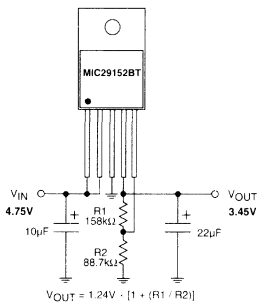

Figure 4. Adjustable Regulator with Resistors

The adjustable regulator versions, MIC29xx2 and MIC29xx3, allow programming the output voltage anywhere between 1.25V and the 26V maximum operating rating of the family. Two resistors are used. Resistors can be quite large, up to 1MΩ, because of the very high input impedance and low bias current of the sense comparator: The resistor values are calculated by:

$$R_1 = R_2 \times \left(\frac{V_{OUT}}{1.240} - 1 \right)$$

Where V_O is the desired output voltage. Figure 4 shows component definition. Applications with widely varying load currents may scale the resistors to draw the minimum load current required for proper operation (see above).

Error Flag

MIC29xx1 and MIC29xx3 versions feature an Error Flag, which looks at the output voltage and signals an error condition when this voltage drops 5% below its expected value. The error flag is an open-collector output that pulls low under fault conditions. It may sink 10mA. Low output voltage signifies a number of possible problems, including an over-current fault (the device is in current limit) and low input voltage. The flag output is inoperative during overtemperature shutdown conditions.

Enable Input

MIC29xx1 and MIC29xx2 versions feature an enable (EN) input that allows ON/OFF control of the device. Special design allows “zero” current drain when the device is disabled—only microamperes of leakage current flows. The EN input has TTL/CMOS compatible thresholds for simple interfacing with logic, or may be directly tied to $\leq 30V$. Enabling the regulator requires approximately 20µA of current.

General Description

The MIC29310 and MIC29312 are high-current, high-accuracy, low-dropout voltage regulators featuring fast transient recovery from input voltage surges and output load current changes. These regulators use a PNP pass element that features Micrel's proprietary Super Beta PNP™ process.

The MIC29310/2 is available in two versions: the three-pin fixed output MIC29310 and the five pin adjustable output voltage MIC29312. All versions are fully protected against overcurrent faults, reversed input polarity, reversed lead insertion, overtemperature operation, and positive and negative transient voltage spikes.

A TTL compatible enable (EN) control pin supports external on/off control. If on/off control is not required, the device may be continuously enabled by connecting EN to IN.

The MIC29310/2 is available in the standard three and five pin TO-220 package with an operating junction temperature range of 0°C to +125°C.

For applications requiring even lower dropout voltage, input voltage greater than 16V, or an error flag, see the MIC29300/29301/29302/29303.

Features

- Fast transient response
- 3A current over full temperature range
- 600mV dropout voltage at full load
- Low ground current
- Accurate 1% guaranteed tolerance
- "Zero" current shutdown mode (MIC29312)
- Fixed voltage and adjustable versions

Applications

- Pentium™ and Power PC™ processor supplies
- High-efficiency "green" computer systems
- High-efficiency linear power supplies
- High-efficiency switching supply post regulator
- Battery-powered equipment

Ordering Information

Part Number	Temp. Range*	Voltage	Current	Package
MIC29310-3.3BT	0°C to +125°C	3.3V	3.0A	TO-220-3
MIC29310-5.0BT	0°C to +125°C	5.0V	3.0A	TO-220-3
MIC29312BT	0°C to +125°C	Adj.	3.0A	TO-220-5

* Junction Temperature

Typical Application

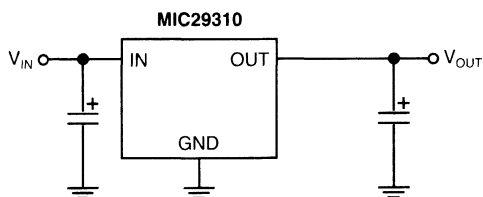

Fixed Regulator Configuration

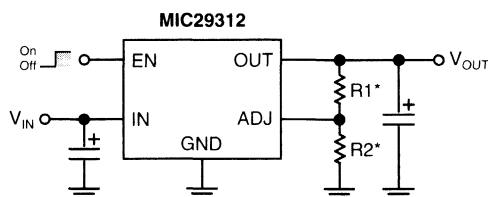

$$V_{OUT} = 1.240 \left(\frac{R1}{R2} + 1 \right)$$

* For best performance, total series resistance (R1 + R2) should be small enough to pass the minimum regulator load current of 10mA.

Adjustable Regulator Configuration

Pin Configuration

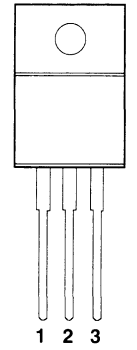

MIC29310BT

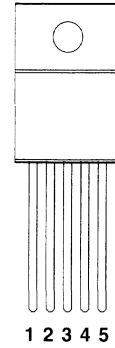

MIC29312BT

On all devices, the Tab is grounded.

Pin Description

3-Pin TO-220 (MIC29310)

Pin Number	Pin Name	Pin Function
1	IN	Unregulated Input: +16V maximum supply.
2	GND	Ground: Internally connected to tab (ground).
3	OUT	Regulated Output

5-Pin TO-220 (MIC29312)

Pin Number	Pin Name	Pin Function
1	EN	Enable (Input): Logic-level ON/OFF control.
2	IN	Unregulated Input: +16V maximum supply.
3	GND	Ground: Internally connected to tab (ground).
4	OUT	Regulated Output
5	ADJ	Output Voltage Adjust: 1.240V feedback from external resistive divider.

Absolute Maximum Ratings

Input Supply Voltage (Note 1)	-20V to +20V
Power Dissipation	Internally Limited
Storage Temperature Range	-65°C to +150°C
Lead Temperature (Soldering, 5 sec.)	260°C

Operating Ratings

Operating Junction Temperature	0°C to +125°C
θ_{JC} (TO-220)	2°C/W
θ_{JA} (TO-220)	55°C/W

Electrical Characteristics

All measurements at $T_J = 25^\circ\text{C}$ unless otherwise noted. **Bold** values are guaranteed across the operating temperature range.

Parameter	Condition	Min	Typ	Max	Units
Output Voltage	$10\text{mA} \leq I_O \leq I_{FL}$, $(V_{OUT} + 1\text{V}) \leq V_{IN} \leq 8\text{V}$ (Note 2)	-2		2	%
Line Regulation	$I_O = 10\text{mA}$, $(V_{OUT} + 1\text{V}) \leq V_{IN} \leq 16\text{V}$		0.06	0.5	%
Load Regulation	$V_{IN} = V_{OUT} + 1\text{V}$, $10\text{mA} \leq I_{OUT} \leq I_{FULL\ LOAD}$ (Notes 2, 6)		0.2	1	%
$\Delta V_O / \Delta T$	Output Voltage Temperature Coefficient (Note 6)		20	100	ppm/ $^\circ\text{C}$
Dropout Voltage	$\Delta V_{OUT} = -1\%$, (Note 3) MIC29310/29312 $I_O = 100\text{mA}$ $I_O = 750\text{mA}$ $I_O = 1.5\text{A}$ $I_O = 3\text{A}$		80 220 330 600	200 1000	mV mV mV mV
Ground Current	MIC29310/29312 $I_O = 750\text{mA}$, $V_{IN} = V_{OUT} + 1\text{V}$ $I_O = 1.5\text{A}$ $I_O = 3\text{A}$		5 15 60	20 150	mA mA mA
I_{GNDDO} Ground Pin Current at Dropout	$V_{IN} = 0.5\text{V}$ less than specified V_{OUT} , $I_{OUT} = 10\text{mA}$		2	3	mA
Current Limit	MIC29310/29312 $V_{OUT} = 0\text{V}$ (Note 4)	3.0	3.8		A
Minimum Load Current			7	10	mA
e_n , Output Noise Voltage (10Hz to 100kHz) $I_L = 100\text{mA}$	$C_L = 10\mu\text{F}$ $C_L = 33\mu\text{F}$		400 260		μV_{RMS} μV_{RMS}

Reference (MIC29312 only)

Reference Voltage	$10\text{mA} \leq I_O \leq I_{FL}$, $V_{OUT} + 1\text{V} \leq V_{IN} \leq 8\text{V}$ (Note 2)	1.215		1.265	V_{MAX}
Adjust Pin Bias Current			40	80 120	nA nA
Reference Voltage Temperature Coefficient	(Note 7)		20		ppm/ $^\circ\text{C}$
Adjust Pin Bias Current Temperature Coefficient			0.1		nA/ $^\circ\text{C}$

Parameter	Conditions	Min	Typical	Max	Units
Enable Input (MIC29312 only)					
Input Logic Voltage	Low (Off)			0.8	V
	High (On)	2.4			V
Enable (EN) Pin Input Current	$V_{EN} = V_{IN}$		15	30	μA
	$V_{EN} = 0.8V$		-	2	μA
Regulator Output Current in Shutdown	(Note 8)		10	20	μA

General Note: Devices are ESD sensitive. Handling precautions recommended.

Note 1: The maximum continuous supply voltage is 16V.

Note 2: Full Load current is defined as 3A for the MIC29310/29312. For testing, V_{OUT} is programmed to 5V.

Note 3: Dropout voltage is defined as the input-to-output differential when the output voltage drops to 99% of its nominal value with $V_{OUT} + 1V$ applied to V_{IN} .

Note 4: For this test, V_{IN} is the larger of 8V or $V_{OUT} + 3V$.

Note 5: Ground pin current is the regulator quiescent current. The total current drawn from the source is the sum of the load current plus the ground pin current.

Note 6: Output voltage temperature coefficient is defined as the worst case voltage change divided by the total temperature range.

Note 7: $V_{REF} \leq V_{OUT} \leq (V_{IN} - 1V)$, $2.4V \leq V_{IN} \leq 16V$, $10mA < I_L \leq I_{FL}$, $T_J \leq T_{JMAX}$.

Note 8: $V_{EN} \leq 0.8V$ and $V_{IN} \leq 8V$, $V_{OUT} = 0$.

Block Diagram

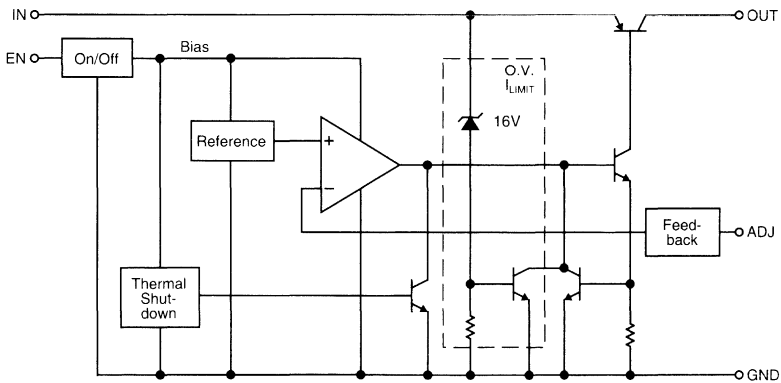

Typical Characteristics

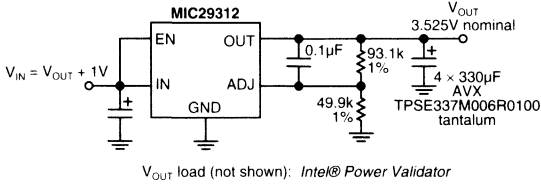

MIC29312 Load Transient Response (See Test Circuit Schematic)

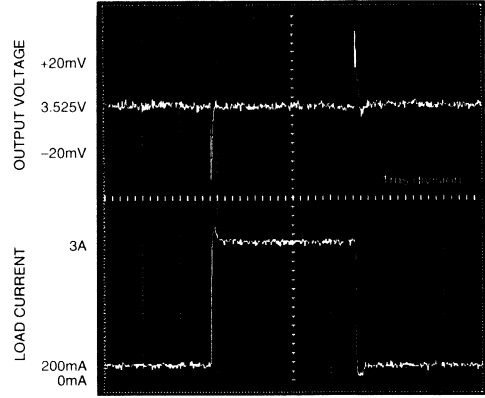

MIC29312 Load Transient Response Test Circuit

MIC29312 Line Transient Response with 3A Load, 10µF Output Capacitance

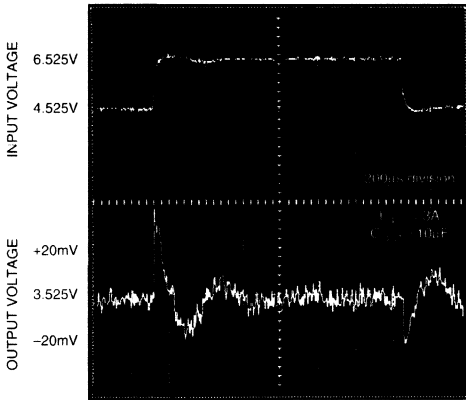

MIC29312 Line Transient Response with 3A Load, 100µF Output Capacitance

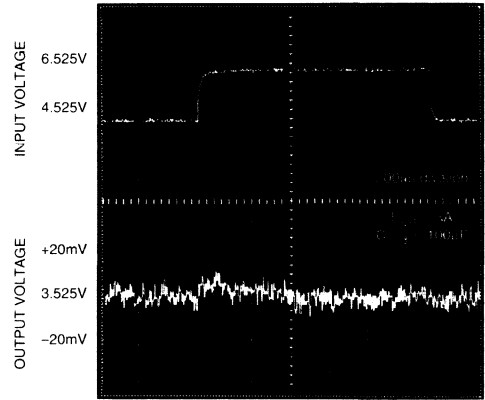

MIC2931x Dropout Voltage vs. Output Current

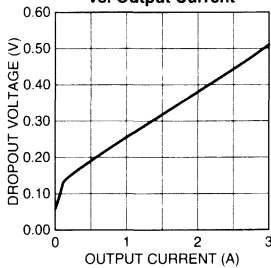

MIC2931x Dropout Voltage vs. Temperature

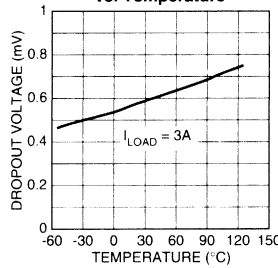

MIC29310-3.3 Dropout Characteristics

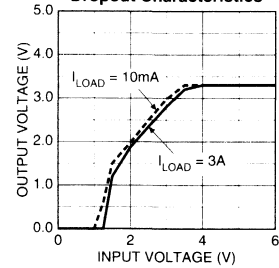

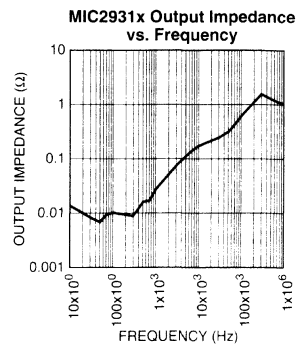
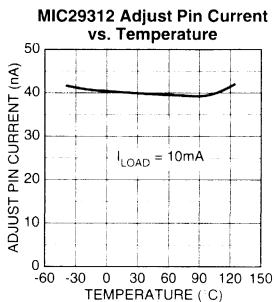
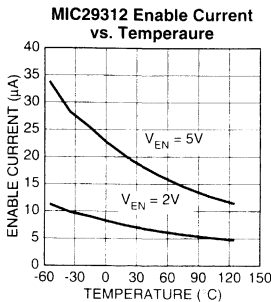
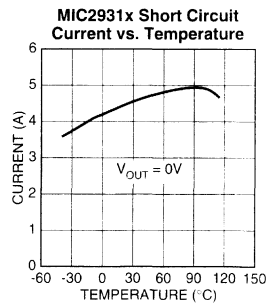
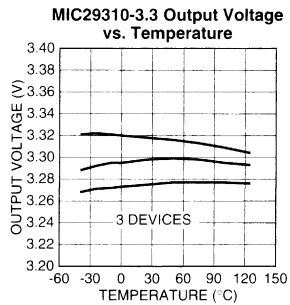
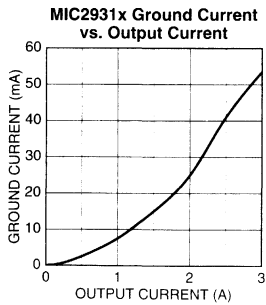
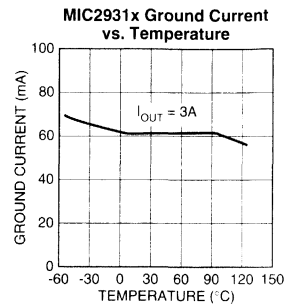
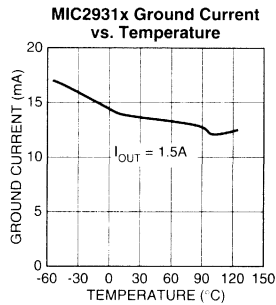
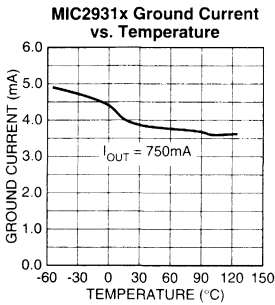
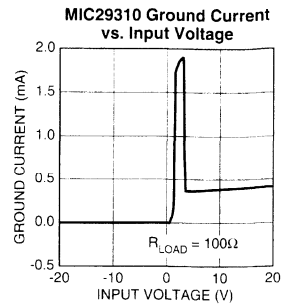
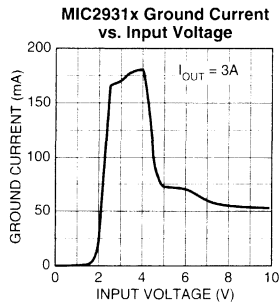
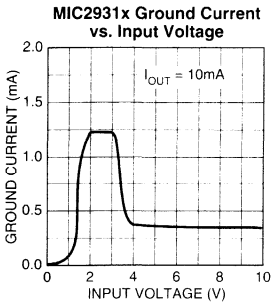

Applications Information

The MIC29310 and MIC29312 are high performance low-dropout voltage regulators suitable for all moderate to high-current voltage regulator applications. Their 600mV of dropout voltage at full load make them especially valuable in battery powered systems and as high efficiency noise filters in “post-regulator” applications. Unlike older NPN-pass transistor designs, where the minimum dropout voltage is limited by the base-emitter voltage drop and collector-emitter saturation voltage, dropout performance of the PNP output of these devices is limited merely by the low V_{CE} saturation voltage.

A trade-off for the low dropout voltage is a varying base drive requirement. But Micrel's Super Beta PNP™ process reduces this drive requirement to merely 2% to 5% of the load current.

MIC29310/312 regulators are fully protected from damage due to fault conditions. Current limiting is provided. This limiting is linear; output current under overload conditions is constant. Thermal shutdown disables the device when the die temperature exceeds the maximum safe operating temperature. Transient protection allows device (and load) survival even when the input voltage spike above and below nominal. The output structure of these regulators allows voltages in excess of the desired output voltage to be applied without reverse current flow. The MIC29312 version offers a logic level ON/OFF control: when disabled, the devices draw nearly zero current.

An additional feature of this regulator family is a common pinout: a design's current requirement may change up or down yet use the same board layout, as all of Micrel's high-current Super Beta PNP™ regulators have identical pinouts.

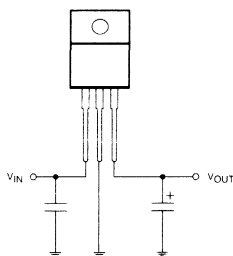

Figure 3. The MIC29310 regulator requires only two capacitors for operation.

Thermal Design

Linear regulators are simple to use. The most complicated design parameters to consider are thermal characteristics. Thermal design requires the following application-specific parameters:

- Maximum ambient temperature, T_A
- Output Current, I_{OUT}
- Output Voltage, V_{OUT}
- Input Voltage, V_{IN}

First, we calculate the power dissipation of the regulator from these numbers and the device parameters from this datasheet.

$$P_D = I_{OUT} \times (1.02V_{IN} - V_{OUT})$$

Where the ground current is approximated by 2% of I_{OUT} . Then the heat sink thermal resistance is determined with this formula:

$$\theta_{SA} = \frac{T_{JMAX} - T_A}{P_D} - (\theta_{JC} + \theta_{CS})$$

Where $T_{JMAX} \leq 125^\circ\text{C}$ and θ_{CS} is between 0 and 2°C/W .

The heat sink may be significantly reduced in applications where the minimum input voltage is known and is large compared with the dropout voltage. Use a series input resistor to drop excessive voltage and distribute the heat between this resistor and the regulator. The low dropout properties of Micrel Super Beta PNP regulators allow very significant reductions in regulator power dissipation and the associated heat sink without compromising performance. When this technique is employed, a capacitor of at least $0.1\mu\text{F}$ is needed directly between the input and regulator ground.

Please refer to Application Note 9 for further details and examples on thermal design and heat sink specification.

Capacitor Requirements

For stability and minimum output noise, a capacitor on the regulator output is necessary. The value of this capacitor is dependent upon the output current; lower currents allow smaller capacitors. MIC29310/2 regulators are stable with a minimum capacitor value of $10\mu\text{F}$ at full load.

This capacitor need not be an expensive low ESR type: aluminum electrolytics are adequate. In fact, extremely low ESR capacitors may contribute to instability. Tantalum capacitors are recommended for systems where fast load transient response is important.

Where the regulator is powered from a source with a high AC impedance, a $0.1\mu\text{F}$ capacitor connected between Input and GND is recommended. This capacitor should have good characteristics to above 250kHz.

Transient Response and 5V to 3.3V Conversion

The MIC29310/2 have excellent response to variations in input voltage and load current. By virtue of their low dropout voltage, these devices do not saturate into dropout as readily as similar NPN-based designs. A 3.3V output Micrel LDO will maintain full speed and performance with an input supply as low as 4.2V, and will still provide some regulation with supplies down to 3.8V, unlike NPN devices that require 5.1V or more for good performance and become nothing more than a resistor under 4.6V of input. Micrel's PNP regulators provide superior performance in “5V to 3.3V” conversion applications than NPN regulators, especially when all tolerances are considered.

Minimum Load Current

The MIC29310/2 regulators are specified between finite loads. If the output current is too small, leakage currents dominate and the output voltage rises. A 10mA minimum load current is necessary for proper regulation.

Adjustable Regulator Design

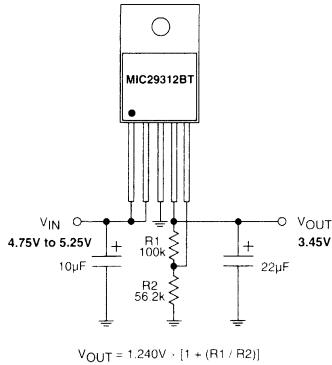

Figure 4. Adjustable Regulator with Resistors

The adjustable regulator version, MIC29312, allows programming the output voltage anywhere between 1.25V and the 15V maximum operating rating of the family. Two resistors are used. Resistors can be quite large, up to 1MΩ, because of the very high input impedance and low bias current of the sense comparator. The resistor values are calculated by:

$$R1 = R2 \times \left(\frac{V_{OUT}}{1.240} - 1 \right)$$

Where V_O is the desired output voltage. Figure 4 shows component definition. Applications with widely varying load currents may scale the resistors to draw the minimum load current required for proper operation (see the table below).

Enable Input

The MIC29312 version features an enable (EN) input that allows ON/OFF control of the device. Special design allows “zero” current drain when the device is disabled—only microamperes of leakage current flows. The EN input has TTL/CMOS compatible thresholds for simple interfacing with logic, or may be directly tied to V_{IN} . Enabling the regulator requires approximately 20µA of current into the EN pin.

Resistor Value Table for the MIC29312 Adjustable Regulator

Voltage	Standard (Ω)		Min. Load (Ω)	
	R1	R2	R1	R2
2.85	100k	76.8k	162	124
2.9	100k	75.0k	165	124
3.0	100k	69.8k	174	124
3.1	100k	66.5k	187	124
3.15	100k	64.9k	191	124
3.3	100k	60.4k	205	124
3.45	100k	56.2k	221	124
3.6	100k	52.3k	237	124
3.8	100k	48.7k	255	124
4.0	100k	45.3k	274	124
4.1	100k	43.2k	287	124

Note: This regulator has a minimum load requirement. “Standard” values assume the load meets this requirement. “Minimum Load” values are calculated to draw 10mA and allow regulation with an open load (the minimum current drawn from the load may be zero).

General Description

The MIC29510 and MIC29512 are high-current, high-accuracy, low-dropout voltage regulators featuring fast transient recovery from input voltage surges and output load current changes. These regulators use a PNP pass element that features Micrel's proprietary Super Beta PNP™ process.

The MIC29510/2 is available in two versions: the three pin fixed output MIC29510 and the five pin adjustable output voltage MIC29512. All versions are fully protected against overcurrent faults, reversed input polarity, reversed lead insertion, overtemperature operation, and positive and negative transient voltage spikes.

A TTL compatible enable (EN) control pin supports external on/off control. If on/off control is not required, the device can be continuously enabled by connecting EN to IN.

The MIC29510/2 is available in the standard three and five pin TO-220 package with an operating junction temperature range of 0°C to +125°C.

For applications requiring even lower dropout voltage, input voltage greater than 16V, or an error flag, see the MIC29500/29501/29502/29503.

Features

- Fast transient response
- 5A current capability
- 700mV dropout voltage at full load
- Low ground current
- Accurate 1% guaranteed tolerance
- "Zero" current shutdown mode (MIC29512)
- Fixed voltage and adjustable versions

Applications

- Pentium™ and Power PC™ processor supplies
- High-efficiency "green" computer systems
- High-efficiency linear power supplies
- High-efficiency switching supply post regulator
- Battery-powered equipment

Ordering Information

Part Number	Temp. Range*	Voltage	Current	Package
MIC29510-3.3BT	0°C to +125°C	3.3V	5.0A	TO-220-3
MIC29510-5.0BT	0°C to +125°C	5.0V	5.0A	TO-220-3
MIC29512BT	0°C to +125°C	Adj.	5.0A	TO-220-5

* Junction Temperature

Typical Application

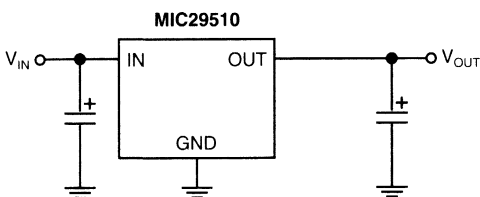

Fixed Regulator Configuration

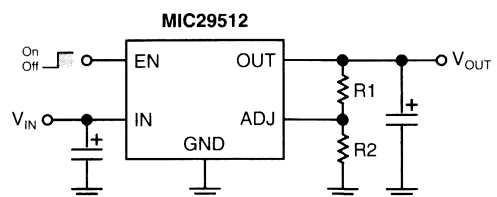

$$V_{OUT} = 1.240 \left(\frac{R1}{R2} + 1 \right)$$

Adjustable Regulator Configuration

Pin Configuration

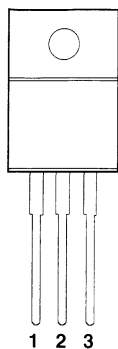

MIC29510BT

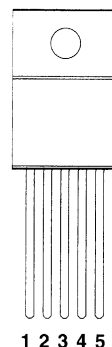

MIC29512BT

On all devices, the Tab is grounded.

Pin Description

3-Pin TO-220 (MIC29510)

Pin Number	Pin Name	Pin Function
1	IN	Unregulated Input: +16V maximum supply.
2	GND	Ground: Internally connected to tab (ground).
3	OUT	Regulated Output

5-Pin TO-220 (MIC29512)

Pin Number	Pin Name	Pin Function
1	EN	Enable (Input): Logic-level ON/OFF control.
2	IN	Unregulated Input: +16V maximum supply.
3	GND	Ground: Internally connected to tab (ground).
4	OUT	Regulated Output
5	ADJ	Output Voltage Adjust: 1.240V feedback from external resistive divider.

Absolute Maximum Ratings

Input Supply Voltage (Note 1) -20V to +20V
 Power Dissipation Internally Limited
 Storage Temperature Range -65°C to +150°C
 Lead Temperature (Soldering, 5 sec.) 260°C

Operating Ratings

Operating Junction Temperature 0°C to +125°C
 θ_{JC} (TO-220) 2°C/W
 θ_{JA} (TO-220) 55°C/W

Electrical Characteristics

All measurements at $T_J = 25^\circ\text{C}$ unless otherwise noted. **Bold** values are guaranteed across the operating temperature range.

Parameter	Condition	Min	Typ	Max	Units
Output Voltage	$10\text{mA} \leq I_O \leq I_{FL}$, $(V_{OUT} + 1\text{V}) \leq V_{IN} \leq 8\text{V}$ (Note 2)	-2		2	%
Line Regulation	$I_O = 10\text{mA}$, $(V_{OUT} + 1\text{V}) \leq V_{IN} \leq 8\text{V}$		0.06	0.5	%
Load Regulation	$V_{IN} = V_{OUT} + 1\text{V}$, $10\text{mA} \leq I_{OUT} \leq I_{FULL\ LOAD}$ (Notes 2, 6)		0.2	1	%
$\Delta V_O / \Delta T$	Output Voltage Temperature Coefficient (Note 6)		20	100	ppm/ $^\circ\text{C}$
Dropout Voltage	$\Delta V_{OUT} = -1\%$, (Note 3) MIC29510/29512 $I_O = 100\text{mA}$ $I_O = 750\text{mA}$ $I_O = 1.5\text{A}$ $I_O = 3\text{A}$ $I_O = 5\text{A}$		80 200 320 500 700	200 1000	mV mV mV mV mV
Ground Current	MIC29510/29512 $I_O = 750\text{mA}$, $V_{IN} = V_{OUT} + 1\text{V}$ $I_O = 1.5\text{A}$ $I_O = 3\text{A}$ $I_O = 5\text{A}$		3 10 36 100	20 150	mA mA mA mA
I_{GNDDO} Ground Pin Current at Dropout	$V_{IN} = 0.5\text{V}$ less than specified V_{OUT} . $I_{OUT} = 10\text{mA}$		2	3	mA
Current Limit	MIC29510/29512 $V_{OUT} = 0\text{V}$ (Note 4)	5.0	6.5		A
e_n Output Noise Voltage (10Hz to 100kHz) $I_L = 100\text{mA}$	$C_L = 47\mu\text{F}$		260		μV_{RMS}

Reference (MIC29512 only)

Reference Voltage	$10\text{mA} \leq I_O \leq I_{FL}$, $V_{OUT} + 1\text{V} \leq V_{IN} \leq 8\text{V}$ (Note 2)	1.215		1.265	V_{MAX}
Adjust Pin Bias Current			40	80 120	nA nA
Reference Voltage Temperature Coefficient	(Note 7)		20		ppm/ $^\circ\text{C}$
Adjust Pin Bias Current Temperature Coefficient			0.1		nA/ $^\circ\text{C}$

Typical Characteristics

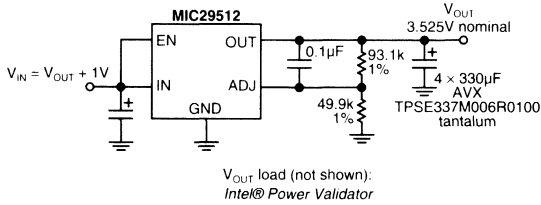

MIC29512 Load Transient Response Test Circuit

MIC29512 Load Transient Response (See Test Circuit Schematic)

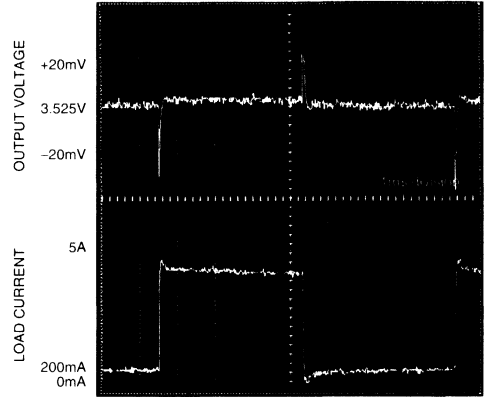

MIC29512 Line Transient Response with 5A Load, 10µF Output Capacitance

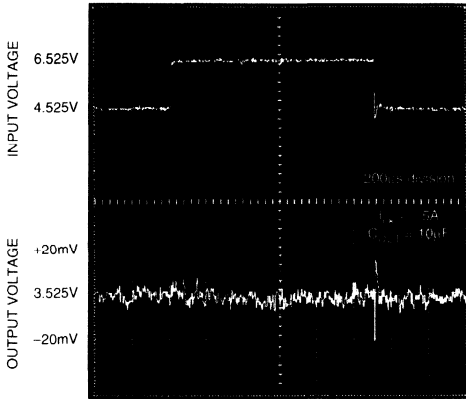

MIC29512 Line Transient Response with 5A Load, 100µF Output Capacitance

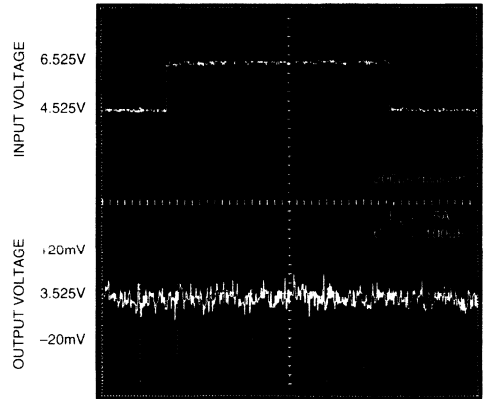

MIC2951x Dropout Voltage vs. Output Current

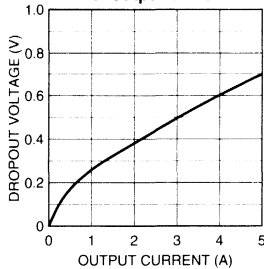

MIC2951x Dropout Voltage vs. Temperature

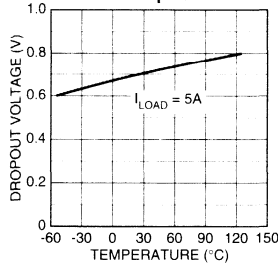

MIC29510-3.3 Dropout Characteristics

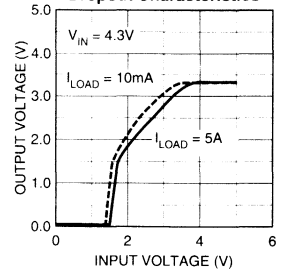

MIC2951x-3.3 Ground Current vs. Supply Voltage

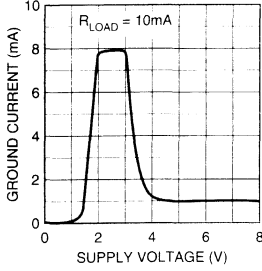

MIC2951x-3.3 Ground Current vs. Supply Voltage

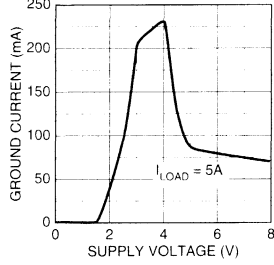

MIC2951x Ground Current vs. Input Voltage

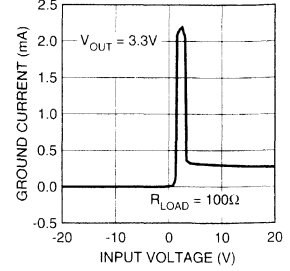

MIC2951x Ground Current vs. Temperature

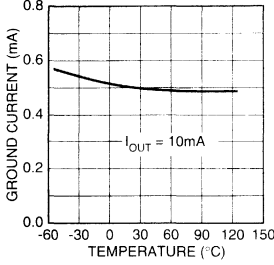

MIC2951x Ground Current vs. Temperature

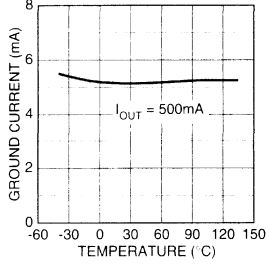

MIC2951x-3.3 Ground Current vs. Temperature

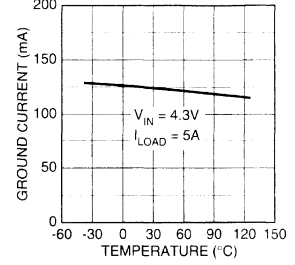

MIC2951x-3.3 Ground Current vs. Output Current

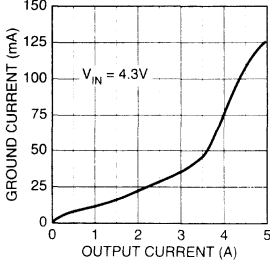

MIC29510-3.3 Output Voltage vs. Temperature

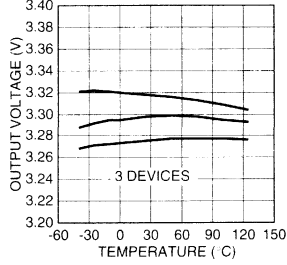

MIC2951x Short Circuit Current vs. Temperature

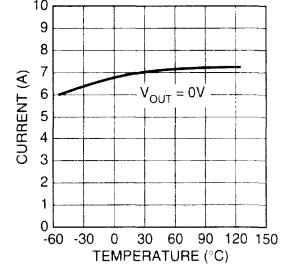

MIC29512 Enable Current vs. Temperature

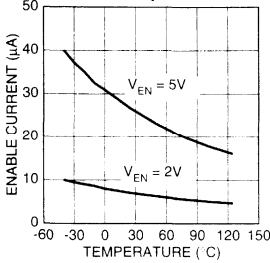

MIC29512 Adjust Pin Current vs. Temperature

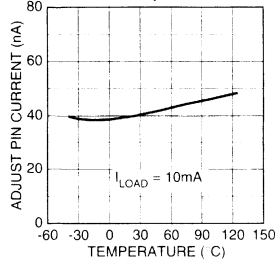

MIC2951x Output Impedance vs. Frequency

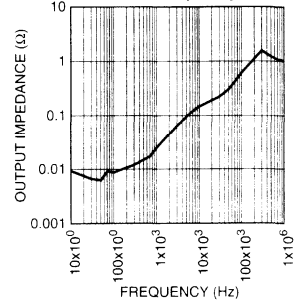

Applications Information

The MIC29510 and MIC29512 are high performance low-dropout voltage regulators suitable for all moderate to high-current voltage regulator applications. Their 600mV of dropout voltage at full load make them especially valuable in battery powered systems and as high efficiency noise filters in “post-regulator” applications. Unlike older NPN-pass transistor designs, where the minimum dropout voltage is limited by the base-emitter voltage drop and collector-emitter saturation voltage, dropout performance of the PNP output of these devices is limited merely by the low V_{CE} saturation voltage.

A trade-off for the low dropout voltage is a varying base drive requirement. But Micrel's Super Beta PNP™ process reduces this drive requirement to merely 2 to 5% of the load current.

MIC29510/512 regulators are fully protected from damage due to fault conditions. Current limiting is provided. This limiting is linear; output current under overload conditions is constant. Thermal shutdown disables the device when the die temperature exceeds the maximum safe operating temperature. Transient protection allows device (and load) survival even when the input voltage spike above and below nominal. The output structure of these regulators allows voltages in excess of the desired output voltage to be applied without reverse current flow. The MIC29512 version offers a logic level ON/OFF control: when disabled, the devices draw nearly zero current.

An additional feature of this regulator family is a common pinout: a design's current requirement may change up or down yet use the same board layout, as all of Micrel's high-current Super Beta PNP™ regulators have identical pinouts.

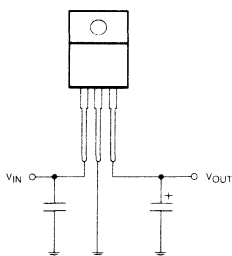

Figure 3. The MIC29510 LDO regulator requires only two capacitors for operation.

Thermal Design

Linear regulators are simple to use. The most complicated design parameters to consider are thermal characteristics. Thermal design requires the following application-specific parameters:

- Maximum ambient temperature, T_A
- Output Current, I_{OUT}
- Output Voltage, V_{OUT}
- Input Voltage, V_{IN}

First, we calculate the power dissipation of the regulator from these numbers and the device parameters from this datasheet.

$$P_D = I_{OUT} \times (1.02V_{IN} - V_{OUT})$$

Where the ground current is approximated by 2% of I_{OUT} . Then the heat sink thermal resistance is determined with this formula:

$$\theta_{SA} = \frac{T_{JMAX} - T_A}{P_D} - (\theta_{JC} + \theta_{CS})$$

Where $T_{JMAX} \leq 125^\circ\text{C}$ and θ_{CS} is between 0 and 2°C/W .

The heat sink may be significantly reduced in applications where the minimum input voltage is known and is large compared with the dropout voltage. Use a series input resistor to drop excessive voltage and distribute the heat between this resistor and the regulator. The low dropout properties of Micrel Super Beta PNP regulators allow very significant reductions in regulator power dissipation and the associated heat sink without compromising performance. When this technique is employed, a capacitor of at least $0.1\mu\text{F}$ is needed directly between the input and regulator ground.

Please refer to Application Note 9 for further details and examples on thermal design and heat sink specification.

Capacitor Requirements

For stability and minimum output noise, a capacitor on the regulator output is necessary. The value of this capacitor is dependent upon the output current; lower currents allow smaller capacitors. MIC29510/2 regulators are stable with a minimum capacitor value of $47\mu\text{F}$ at full load.

This capacitor need not be an expensive low ESR type: aluminum electrolytics are adequate. In fact, extremely low ESR capacitors may contribute to instability. Tantalum capacitors are recommended for systems where fast load transient response is important.

Where the regulator is powered from a source with a high AC impedance, a $0.1\mu\text{F}$ capacitor connected between Input and GND is recommended. This capacitor should have good characteristics to above 250kHz.

Transient Response and 5V to 3.3V Conversion

The MIC29510/2 have excellent response to variations in input voltage and load current. By virtue of their low dropout voltage, these devices do not saturate into dropout as readily as similar NPN-based designs. A 3.3V output Micrel LDO will maintain full speed and performance with an input supply as low as 4.2V, and will still provide some regulation with supplies down to 3.8V, unlike NPN devices that require 5.1V or more for good performance and become nothing more than a resistor under 4.6V of input. Micrel's PNP regulators provide superior performance in “5V to 3.3V” conversion applications than NPN regulators, especially when all tolerances are considered.

Adjustable Regulator Design

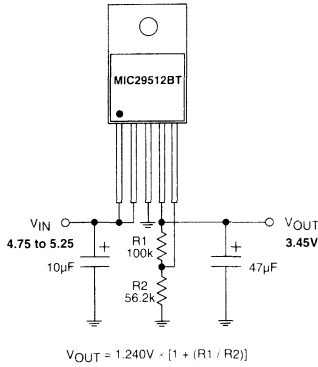

Figure 4. Adjustable Regulator with Resistors

The adjustable regulator version, MIC29512, allows programming the output voltage anywhere between 1.25V and

the 16V maximum operating rating of the family. Two resistors are used. Resistors can be quite large, up to 100kΩ, because of the very high input impedance and low bias current of the sense comparator. The resistor values are calculated by:

$$R1 = R2 \times \left(\frac{V_{OUT}}{1.240} - 1 \right)$$

Where V_O is the desired output voltage. Figure 4 shows component definition.

Enable Input

The MIC29512 versions features an enable (EN) input that allows ON/OFF control of the device. Special design allows “zero” current drain when the device is disabled—only microamperes of leakage current flows. The EN input has TTL/CMOS compatible thresholds for simple interfacing with logic, or may be directly tied to V_{IN} . Enabling the regulator requires approximately 20µA of current into the EN pin.

Resistor Value Table for the MIC29512 Adjustable Regulator

Voltage	Standard (Ω)	
	R1	R2
2.85	100k	76.8k
2.9	100k	75.0k
3.0	100k	69.8k
3.1	100k	66.5k
3.15	100k	64.9k
3.3	100k	60.4k
3.45	100k	56.2k
3.6	100k	52.3k
3.8	100k	48.7k
4.0	100k	45.3k
4.1	100k	43.2k

General Description

The MIC29710 and MIC29712 are high-current, high-accuracy, low-dropout voltage regulators featuring fast transient recovery from input voltage surges and output load current changes. These regulators use a PNP pass element that features Micrel's proprietary Super Beta PNP™ process.

The MIC29710/2 is available in two versions: the three pin fixed output MIC29710 and the five pin adjustable output voltage MIC29712. All versions are fully protected against overcurrent faults, reversed lead insertion, overtemperature operation, and positive and negative transient voltage spikes.

A TTL compatible enable (EN) control pin supports external on/off control. If on/off control is not required, the device may be continuously enabled by connecting EN to IN.

The MIC29710/2 is available in the standard three and five pin TO-220 package with an operating junction temperature range of 0°C to +125°C.

For applications requiring even lower dropout voltage or input voltage greater than 16V, see the MIC29750/29752.

Features

- Fast transient response
- 7.5A current capability
- 700mV dropout voltage at full load
- Low ground current
- Accurate 2% guaranteed tolerance
- "Zero" current shutdown mode (MIC29712)
- No minimum load current
- Fixed voltage and adjustable versions

Applications

- Pentium™, Pentium Plus™, and Power PC™ processor supplies
- High-efficiency "green" computer systems
- High-efficiency linear power supplies
- High-efficiency switching supply post regulator
- Battery-powered equipment

Ordering Information

Part Number	Temp. Range*	Voltage	Current	Package
MIC29710-3.3BT	0°C to +125°C	3.3V	7.5A	TO-220-3
MIC29710-5.0BT	0°C to +125°C	5.0V	7.5A	TO-220-3
MIC29712BT	0°C to +125°C	Adj.	7.5A	TO-220-5

* Junction Temperature

Typical Application

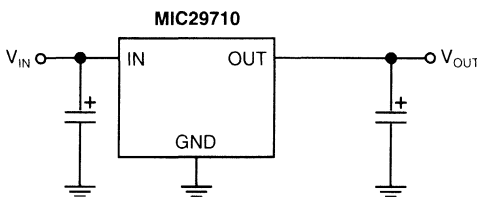

Fixed Regulator Configuration

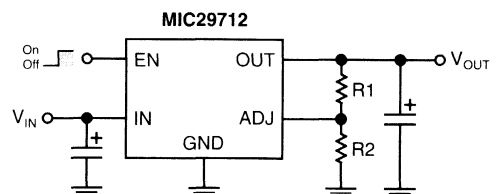

$$V_{OUT} = 1.240 \left(\frac{R1}{R2} + 1 \right)$$

Adjustable Regulator Configuration

Pin Configuration

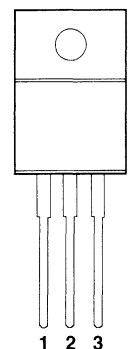

MIC29710BT

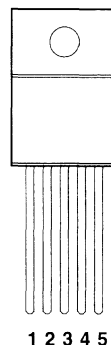

MIC29712BT

On all devices, the Tab is grounded.

Pin Description

3-Pin TO-220 (MIC29710)

Pin Number	Pin Name	Pin Function
1	IN	Unregulated Input: +16V maximum supply.
2	GND	Ground: Internally connected to tab (ground).
3	OUT	Regulated Output

5-Pin TO-220 (MIC29712)

Pin Number	Pin Name	Pin Function
1	EN	Enable (Input): Logic-level ON/OFF control.
2	IN	Unregulated Input: +16V maximum supply.
3	GND	Ground: Internally connected to tab (ground).
4	OUT	Regulated Output
5	ADJ	Output Voltage Adjust: 1.240V feedback from external resistive divider.

Absolute Maximum Ratings

Input Supply Voltage, **Note 1** -0.7 V to +20V
 Power Dissipation Internally Limited
 Storage Temperature Range -65°C to +150°C
 Lead Temperature (Soldering, 5 sec.) 260°C

Operating Ratings

Operating Junction Temperature 0°C to +125°C
 θ_{JC} (TO-220) 2°C/W
 θ_{JA} (TO-220) 55°C/W

Electrical Characteristics

All measurements at $T_J = 25^\circ\text{C}$ unless otherwise noted. **Bold** values are guaranteed across the operating temperature range.

Parameter	Condition	Min	Typ	Max	Units
Output Voltage	$10\text{mA} \leq I_O \leq 7.5\text{A}$, $(V_{OUT} + 1\text{V}) \leq V_{IN} \leq 8\text{V}$, Note 2	-2		2	%
Line Regulation	$I_O = 10\text{mA}$, $(V_{OUT} + 1\text{V}) \leq V_{IN} \leq 8\text{V}$		0.06	0.5	%
Load Regulation	$V_{IN} = V_{OUT} + 1\text{V}$, $10\text{mA} \leq I_{OUT} \leq 7.5\text{A}$, Notes 2, 6		0.2	1	%
Output Voltage Temperature Coefficient	$\Delta V_O/\Delta T$, Note 6		20	100	ppm/ $^\circ\text{C}$
Dropout Voltage	$\Delta V_{OUT} = -1\%$, (Note 3) MIC29710/29712 $I_O = 100\text{mA}$ $I_O = 750\text{mA}$ $I_O = 1.5\text{A}$ $I_O = 3\text{A}$ $I_O = 5\text{A}$ $I_O = 7.5\text{A}$		80 180 220 300 450 700	200 1000	mV mV mV mV mV mV
Ground Current	MIC29710/29712 $I_O = 750\text{mA}$, $V_{IN} = V_{OUT} + 1\text{V}$ $I_O = 1.5\text{A}$ $I_O = 3\text{A}$ $I_O = 5\text{A}$ $I_O = 7.5\text{A}$		6 20 36 100 250	20 375	mA mA mA mA mA
I_{GNDDO} Ground Pin Current at Dropout	$V_{IN} = 0.5\text{V}$ less than specified V_{OUT} . $I_{OUT} = 10\text{mA}$		1	2	mA
Current Limit	MIC29710/29712 $V_{OUT} = 0\text{V}$, Note 4		11	15	A
e_n , Output Noise Voltage (10Hz to 100kHz) $V_{OUT} = 5.0\text{V}$	$C_L = 47\mu\text{F}$ $I_O = 100\text{mA}$		260		μV_{RMS}

Reference (MIC29712 only)

Reference Voltage	$10\text{mA} \leq I_O \leq 7.5\text{A}$, $V_{OUT} + 1\text{V} \leq V_{IN} \leq 8\text{V}$, Note 2	1.215	1.240	1.265	V_{MAX}
Adjust Pin Bias Current			40	80 120	nA nA
Reference Voltage Temperature Coefficient	Note 7		20		ppm/ $^\circ\text{C}$
Adjust Pin Bias Current Temperature Coefficient			0.1		nA/ $^\circ\text{C}$

Typical Characteristics

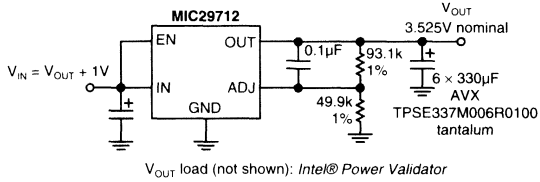

MIC29712 Load Transient Response Test Circuit

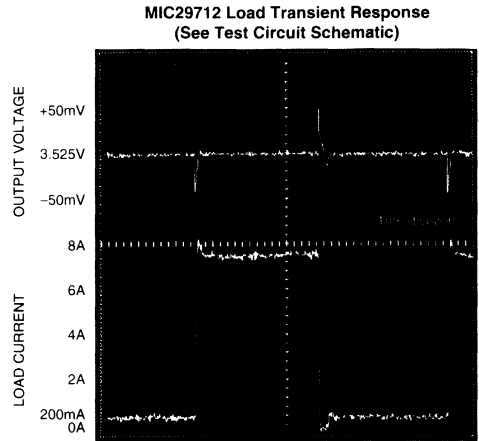

MIC29712 Line Transient Response with 10mA Load, 10µF Output Capacitance

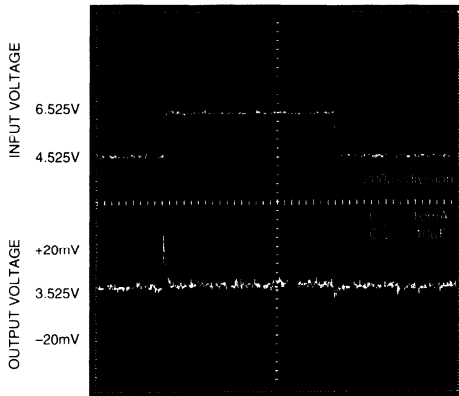

MIC29712 Line Transient Response with 10mA Load, 100µF Output Capacitance

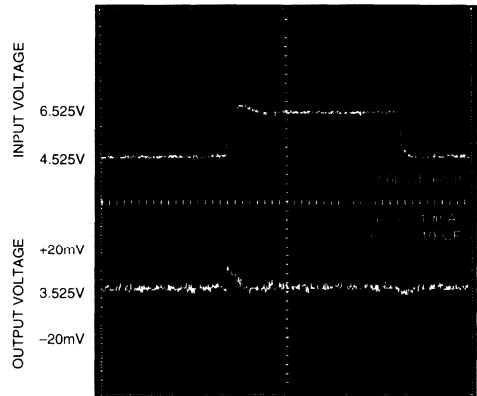

MIC29710/2 Dropout Voltage vs. Output Current

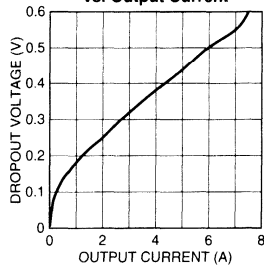

MIC29710/2 Dropout Voltage vs. Temperature

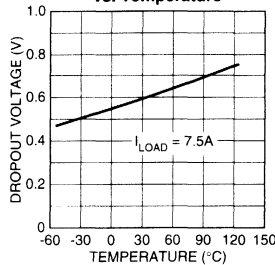

MIC29710-3.3 Dropout Characteristics

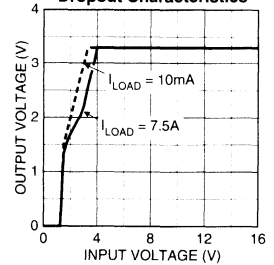

MIC29710/2 Ground Current vs. Input Voltage

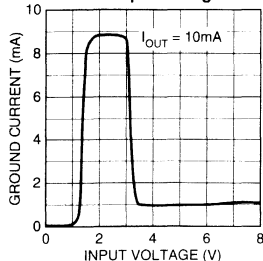

MIC29710/2 Ground Current vs. Input Voltage

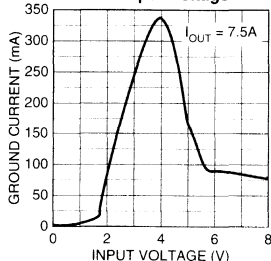

MIC29710/2 Ground Current vs. Temperature

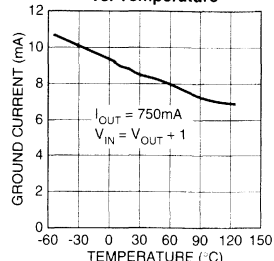

MIC29710/2 Ground Current vs. Temperature

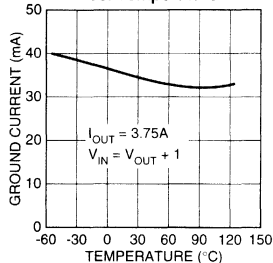

MIC29710/2 Ground Current vs. Temperature

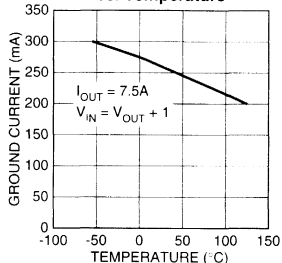

MIC29710/2 Ground Current vs. Output Current

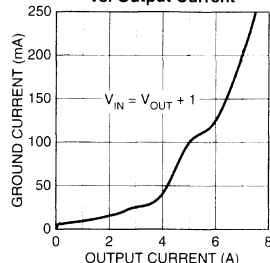

MIC29710-3.3 Output Voltage vs. Temperature

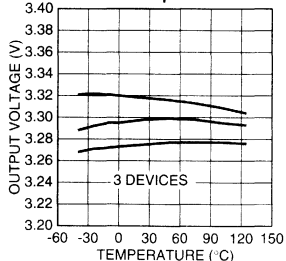

MIC29710/2 Short Circuit Current vs. Temperature

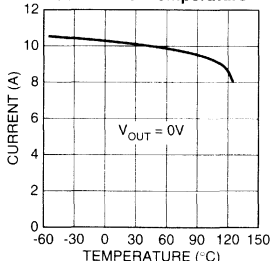

MIC29712 Enable Current vs. Temperature

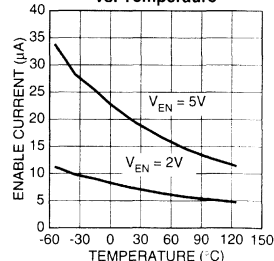

MIC29712 Adjust Pin Current vs. Temperature

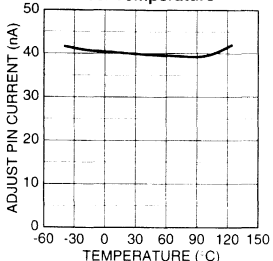

MIC29710/2 Output Impedance vs. Frequency

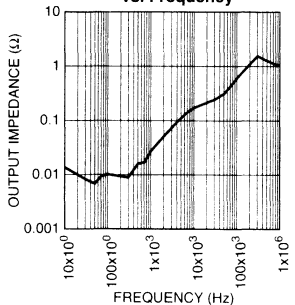

Applications Information

The MIC29710 and MIC29712 are high performance low-dropout voltage regulators suitable for all moderate to high-current voltage regulator applications. Their 700mV of dropout voltage at full load make them especially valuable in battery powered systems and as high efficiency noise filters in “post-regulator” applications. Unlike older NPN-pass transistor designs, where the minimum dropout voltage is limited by the base-emitter voltage drop and collector-emitter saturation voltage, dropout performance of the PNP output of these devices is limited merely by the low V_{CE} saturation voltage. Output regulation is excellent across the input voltage, output current, and temperature ranges. The MIC29710/712 does not have a minimum load current limitation.

A trade-off for the low dropout voltage is a varying base drive requirement. But Micrel’s Super Beta PNP™ process reduces this drive requirement to merely 2 to 5% of the load current.

MIC29710/712 regulators are fully protected from damage due to fault conditions. Current limiting is provided. The output current under overload conditions is limited to a constant value. Thermal shutdown disables the device when the die temperature exceeds the maximum safe operating temperature. Transient protection allows device (and load) survival even when the input voltage spike above and below nominal. The MIC29712 version offers a logic level ON/OFF control: when disabled, the devices draw nearly zero current.

An additional feature of this regulator family is a common pinout: a design’s current requirement may change up or down yet use the same board layout, as all of Micrel’s high-current Super Beta PNP™ regulators have identical pinouts.

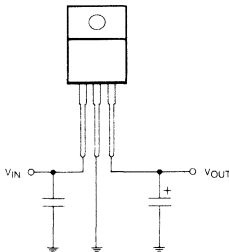

Figure 3. The MIC29710 requires only two capacitors for operation.

Thermal Design

Linear regulators are simple to use. The most complicated design parameters to consider are thermal characteristics. Thermal design requires the following application-specific parameters:

- Maximum ambient temperature, T_A
- Output Current, I_{OUT}
- Output Voltage, V_{OUT}
- Input Voltage, V_{IN}

First, we calculate the power dissipation of the regulator from these numbers and the device parameters from this datasheet.

$$P_D = I_{OUT} \times (1.03V_{IN} - V_{OUT})$$

Where the ground current is approximated by 3% of I_{OUT} . Then the heat sink thermal resistance is determined with this formula:

$$\theta_{SA} = \frac{T_{J\text{MAX}} - T_A}{P_D} - (\theta_{JC} + \theta_{CS})$$

Where $T_{J\text{MAX}} \leq 125^\circ\text{C}$ and θ_{CS} is between 0 and 2°C/W .

The heat sink may be significantly reduced in applications where the minimum input voltage is known and is large compared with the dropout voltage. Use a series input resistor to drop excessive voltage and distribute the heat between this resistor and the regulator. The low dropout properties of Micrel Super Beta PNP regulators allow very significant reductions in regulator power dissipation and the associated heat sink without compromising performance. When this technique is employed, a capacitor of at least $0.1\mu\text{F}$ is needed directly between the input and regulator ground.

Please refer to Application Note 9 for further details and examples on thermal design and heat sink specification.

Capacitor Requirements

For stability and minimum output noise, a capacitor on the regulator output is necessary. The value of this capacitor is dependent upon the output current; lower currents allow smaller capacitors. MIC29710/2 regulators are stable with a minimum capacitor value of $47\mu\text{F}$ at full load.

This capacitor need not be an expensive low ESR type: aluminum electrolytics are adequate. In fact, extremely low ESR capacitors may contribute to instability. Tantalum capacitors are recommended for systems where fast load transient response is important.

Where the regulator is powered from a source with a high AC impedance, a $0.1\mu\text{F}$ capacitor connected between Input and GND is recommended. This capacitor should have good characteristics to above 250kHz.

Transient Response and 5V to 3.3V Conversion

The MIC29710/2 have excellent response to variations in input voltage and load current. By virtue of their low dropout voltage, these devices do not saturate into dropout as readily as similar NPN-based designs. A 3.3V output Micrel LDO will maintain full speed and performance with an input supply as low as 4.2V, and will still provide some regulation with supplies down to 3.8V, unlike NPN devices that require 5.1V or more for good performance and become nothing more than a resistor under 4.6V of input. Micrel’s PNP regulators provide superior performance in “5V to 3.3V” conversion applications, especially when all tolerances are considered.

Adjustable Regulator Design

The adjustable regulator version, MIC29712, allows programming the output voltage anywhere between 1.25V and the 16V maximum operating rating of the family. Two resistors are used. Resistors can be quite large, up to 100k Ω , because of the very high input impedance and low bias current of the sense comparator. The resistor values are calculated by:

$$R1 = R2 \times \left(\frac{V_{OUT}}{1.240} - 1 \right)$$

Where V_O is the desired output voltage. Figure 4 shows component definition.

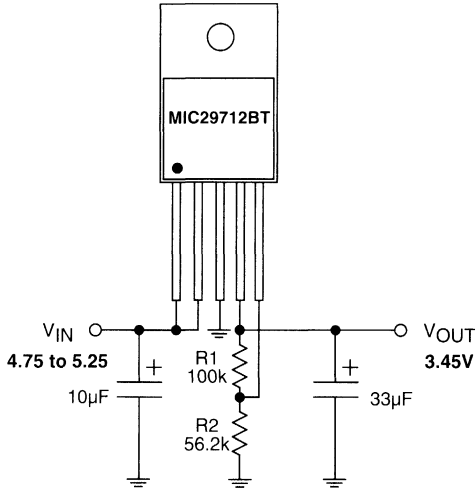

$$V_{OUT} = 1.240V \times [1 + (R1 / R2)]$$

Figure 4. Adjustable Regulator with Resistors

Enable Input

The MIC29712 versions features an enable (EN) input that allows ON/OFF control of the device. Special design allows "zero" current drain when the device is disabled—only microamperes of leakage current flows. The EN input has TTL/CMOS compatible thresholds for simple interfacing with logic, or may be directly tied to V_{IN} . Enabling the regulator requires approximately 20 μ A of current into the EN pin.

Voltage	Standard (Ω)	
	R1	R2
2.85	100k	76.8k
2.9	100k	75.0k
3.0	100k	69.8k
3.1	100k	66.5k
3.15	100k	64.9k
3.3	100k	60.4k
3.45	100k	56.2k
3.525	93.1k	51.1k
3.6	100k	52.3k
3.8	100k	48.7k
4.0	100k	45.3k
4.1	100k	43.2k

Figure 5. MIC29712 Resistor Table

General Description

The MIC5156, MIC5157, and MIC5158 Super Low-Dropout (LDO) Regulator Controllers are single IC solutions for high-current low-dropout linear voltage regulation. Super LDO™ Regulators have the advantages of an external N-channel power MOSFET as the linear pass element.

The MIC5156/7/8 family features a dropout voltage as low as the $R_{DS(ON)}$ of the external power MOSFET multiplied by the output current. The output current can be as high as the largest MOSFETs can provide.

The MIC5156/7/8 family operates from 3V to 36V. The MIC5156 requires an external gate drive supply to provide the higher voltage needed to drive the gate of the external MOSFET. The MIC5157 and MIC5158 each have an internal charge pump tripler to produce the gate drive voltage. The tripler is capable of providing enough voltage to drive a logic-level MOSFET to 3.3V output from a 3.5V supply and is clamped to 17.5V above the supply voltage. The tripler requires three external capacitors.

The regulator output is constant-current limited when the controller detects 35mV across an optional external sense resistor. An active-low open-collector flag indicates a low voltage of 8% or more below nominal output. A shutdown (low) signal to the TTL-compatible enable control reduces controller supply current to less than 1µA while forcing the output voltage to ground.

The MIC5156-3.3 and MIC5156-5.0 controllers have internally fixed output voltages. The MIC5156 [adjustable] output is configured using two external resistors. The MIC5157 is a fixed output controller which is externally configured to select

either 3.3V, 5.0V, or 12V. The MIC5158 can be configured as a fixed 5V controller or programmed to any voltage from 1.3V to 36V using two external resistors.

The MIC5156 is available in an 8-pin plastic DIP, ceramic DIP, or SOIC package. The MIC5157 and MIC5158 are available in a 14-pin plastic DIP, ceramic DIP, or SOIC. The plastic DIP and SOIC versions operate from -40°C to +85°C. The ceramic DIP versions cover the -55°C to +125°C military temperature range.

Features

- 4.5mA typical operating current
- <1µA typical standby current
- Low external parts count
- Optional current limit (35mV typical threshold)
- 1% initial output voltage tolerance in most configurations
- 2% output voltage tolerance over temperature
- Fixed output voltages of 3.3V, 5.0V (MIC5156)
- Fixed output voltages of 3.3V, 5.0V, 12V (MIC5157)
- Programmable (1.3 to 36V) with 2 resistors (MIC5156/8)
- Internal charge pump voltage tripler (MIC5157/8)
- Enable pin to activate or shutdown the regulator
- Internal gate-to-source protective clamp
- All versions available in DIP and SOIC

Applications

- Ultra-high current ultra-low dropout voltage regulator
- Constant high-current source
- Low parts count 5.0V to 3.3V computer supply
- Low noise/low-dropout SMPS post regulator
- High-current, current-limited switch

Typical Applications

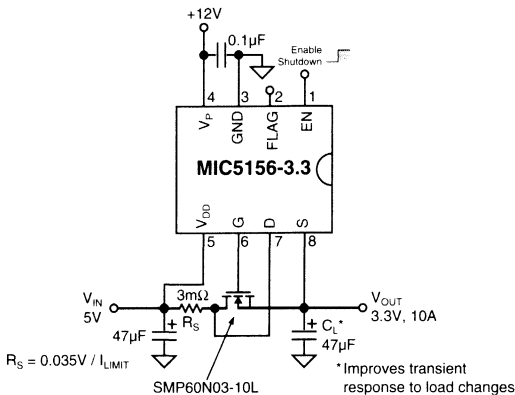

10A 5V to 3.3V Desktop Computer Regulator

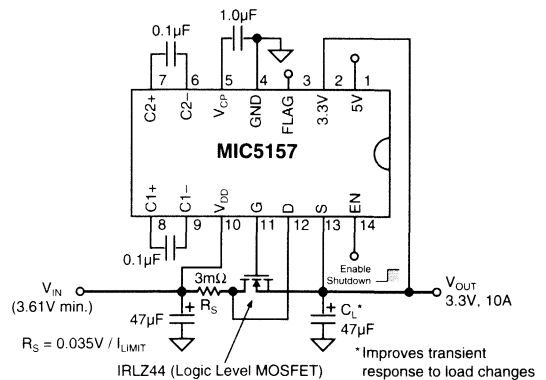

10A Low-Dropout Voltage Regulator

Super LDO is a trademark of Micrel, Inc.

Ordering Information MIC5156

Part Number	Temperature Range	Voltage	Package
MIC5156-3.3BN	-40°C to +85°C	3.3V	8-pin P-DIP
MIC5156-5.0BN	-40°C to +85°C	5.0V	8-pin P-DIP
MIC5156BN	-40°C to +85°C	Adjustable	8-pin P-DIP
MIC5156-3.3BM	-40°C to +85°C	3.3V	8-pin SOIC
MIC5156-5.0BM	-40°C to +85°C	5.0V	8-pin SOIC
MIC5156BM	-40°C to +85°C	Adjustable	8-pin SOIC
MIC5156-3.3AJ	-55°C to +125°C	3.3V	8-pin CerDIP
MIC5156-5.0AJ	-55°C to +125°C	5.0V	8-pin CerDIP
MIC5156AJ	-55°C to +125°C	Adjustable	8-pin CerDIP

Ordering Information MIC5157

Part Number	Temperature Range	Voltage	Package
MIC5157BN	-40°C to +85°C	Selectable	14-pin P-DIP
MIC5157BM	-40°C to +85°C	Selectable	14-pin SOIC
MIC5157AJ	-55°C to +125°C	Selectable	14-pin CerDIP

Ordering Information MIC5158

Part Number	Temperature Range	Voltage	Package
MIC5158BN	-40°C to +85°C	5.0V/Adj.	14-pin P-DIP
MIC5158BM	-40°C to +85°C	5.0V/Adj.	14-pin SOIC
MIC5158AJ	-55°C to +125°C	5.0V/Adj.	14-pin CerDIP

Pin Configuration

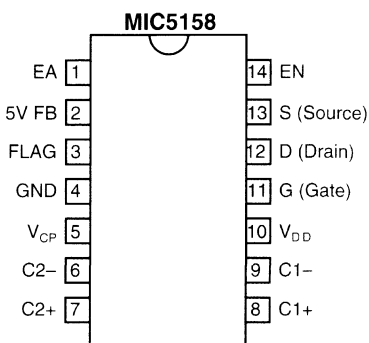
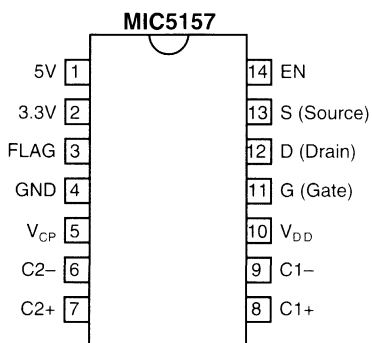
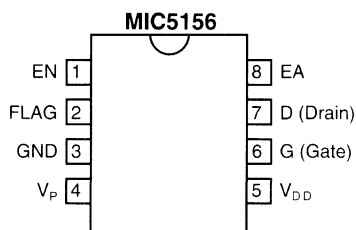
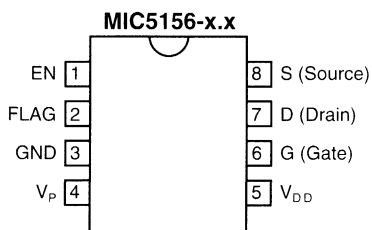

Pin Description MIC5156

Pin Number	Pin Name	Pin Function
1	EN	Enable (Input): TTL high enables regulator; TTL low shuts down regulator.
2	FLAG	Output Flag (Output): Open collector output is active (low) when V_{OUT} is more than 8% below nominal output. Circuit has 3% hysteresis.
3	GND	Circuit ground.
4	V_P	N-channel Gate Drive Supply Voltage: User supplied voltage for driving the gate of the external MOSFET.
5	V_{DD}	Supply Voltage (Input): Supply voltage connection. Connect sense resistor (R_S) to V_{DD} if current limiting used. Connect supply bypass capacitor to ground near device.
6	G	Gate (Output): Drives the gate of the external MOSFET.
7	D	Drain and Current Limit (Input): Connect to external MOSFET drain and external sense resistor (current limit), or connect to V_{DD} and external MOSFET drain (no current limit).
8 (3.3V, 5V)	S	Source (Input): Top of internal resistive divider chain. Connect directly to the load for best load regulation.
8 (adjustable)	EA	Error Amplifier (Input): Connect to external resistive divider.

Pin Description MIC5157, MIC5158

Pin Number	Pin Name	Pin Function
1 (MIC5157)	5V	5V Configuration (Input): Connect to S (source) pin for 5V output.
1 (MIC5158)	EA	Error Amplifier (Input): Connect to external resistive divider to obtain adjustable output.
2 (MIC5157)	3.3V	3.3V Configuration (Input): Connect to S (source) pin for 3.3V output.
2 (MIC5158)	5V FB	5V Feedback (Input): Connect to EA for fixed 5V output.
3	FLAG	Output Voltage Flag (Output): Open collector is active (low) when V_{OUT} is 8% or more below its nominal value.
4	GND	Circuit ground.
5	V_{CP}	Voltage Tripler Output [Filter Capacitor]. Connect a 1 to 10 μ F capacitor to ground.
6	C2-	Charge Pump Capacitor 2: Second stage of internal voltage tripler. Connect a 0.1 μ F capacitor from C2+ to C2-.
7	C2+	Charge Pump Capacitor 2: See C2- pin 6.
8	C1+	Charge Pump Capacitor 1: First stage of internal voltage tripler. Connect a 0.1 μ F capacitor from C1+ to C1-.
9	C1-	Charge Pump Capacitor 1: See C1+ pin 8.
10	V_{DD}	Supply Voltage (Input): Supply voltage connection. Connect sense resistor (R_S) to V_{DD} if current limiting used. Connect supply bypass capacitor to ground near device.
11	G	Gate (Output): Connect to External MOSFET gate.
12	D	Drain and Current Limit (Input): Connect to external MOSFET drain and external sense resistor (current limit), or connect to V_{DD} and external MOSFET drain (no current limit).
13 (MIC5157)	S	Source and 3.3V/5V Configuration: Top of internal resistor chain. Connect to source of external MOSFET for 3.3V, 5V, and 12V operation. Also see 3.3V and 5V pin descriptions.
13 (MIC5158)	S	Source (Input): Top of internal resistor chain. Connect to top of external resistive divider and source of external MOSFET.
14	EN	Enable (Input): TTL high enables regulator; TTL low shuts down regulator.

Absolute Maximum Ratings

V_{DD}	38V
EN	-0.3V to 36V
V_G (MIC5156)	55V
V_{CP} (MIC5157/8)	55V
V_{SOURCE}	1.3 to 36V
FLAG	-0.3 to 40V
Operating Junction Temperature T_J	150°C

Ambient Temperature Range

T_A (MIC515xBM/BN)	-40°C to +85°C
T_A (MIC515xAJ)	-55°C to +125°C
Storage Temperature	-65°C to +150°C
Lead Temperature (soldering 10s)	300°C
Package θ_{JA}	MIC5156 MIC5157/8
Plastic DIP	100°C/W 90°C/W
Ceramic DIP	125°C/W 110°C/W
SOIC	170°C/W 145°C/W

Electrical Characteristics

Symbol	Parameter	Condition (Note 1)	Min	Typ	Max	Units
V_{DD}	Supply Voltage		3		36	V
$I_{DD(ON)}$ $I_{DD(OFF)}$	Supply Current MIC5156	Operating, $V_{EN} = 5V$ Shutdown, $V_{EN} = 0V$		2.7 0.1	10 5	mA μA
$I_{DD(ON)}$ $I_{DD(OFF)}$	Supply Current MIC5157/8	Operating, $V_{EN} = 5V$ Shutdown, $V_{EN} = 0V$		4.5 0.1	10 5	mA μA
V_{IH} V_{IL}	Enable Input Threshold	High Low	2.4	1.3 1.3		V V
EN I_B	Enable Input Bias Current	$V_{EN} = 2.4V$		20	25	μA
V_{CP}	Max. Charge Pump Voltage	$V_{CP} - V_{DD}$, $V_{DD} > 10V$		17.5	18.5	V
f_{CP}	Charge Pump Frequency			160		kHz
$V_{OUT MAX}$	Maximum Gate Drive Voltage (MIC5157/8)	$V_{SOURCE} = 0V$ $V_{DD} = 3.5V$ $V_{DD} = 5V$ $V_{DD} = 12V$	5 9 24	7.0 11.3 28	9 15 30	V V V
$V_{OUT MIN}$	Minimum Gate Drive Voltage	$V_{SOURCE} > V_{OUT(NOM)}$		1.0		V
V_{LIM}	Current Limit Threshold	$V_{DD} - V_D @ I_{LIM}$	28	35	42	mV
V_S	Source Voltage	Short G (gate) to (S) source, Note 2 MIC5156-3.3 MIC5156-5.0 MIC5157, 3.3V pin to S pin (3.3V config.) MIC5157, 5V pin to S pin (5V config.) MIC5157, $V_{DD} = 7V$, (12V config.) MIC5158, 5V FB pin to EA pin (5V config.)	3.267 4.950 3.250 4.950 11.70 4.925	3.3 5.0 3.3 5.0 12 5.0	3.333 5.050 3.350 5.050 12.30 5.075	V V V V V V
V_{BG}	Bandgap Reference Voltage	MIC5156 [adjustable] and MIC5158	1.222	1.235	1.248	V
V_{LR}	Output Voltage Line Regulation	$5V < V_{DD} < 15V$, $V_{OUT} = 3.3V$		2	7	mV
$V_{GS MAX}$	Gate to Source Clamp		14	16.6	20	V
V_{FT}	Flag Comparator Threshold	% of nominal V_{SOURCE}		92		%
V_{FH}	Flag Comparator Hysteresis	% of nominal V_{SOURCE}		3		%
V_{SAT}	Flag Comparator Sat. Voltage	$I_{FLAG} = 1mA$		0.09	0.2	V

General Note: Devices are ESD sensitive. Handling precautions recommended.

Note 1: $T_A = 25^\circ C$, $V_{DD} = 5V$, $V_{EN} = 5V$, unless noted.

Note 2: Test configuration. External MOSFET not used.

Typical Characteristics

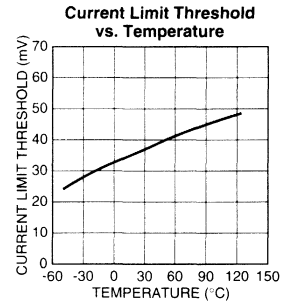
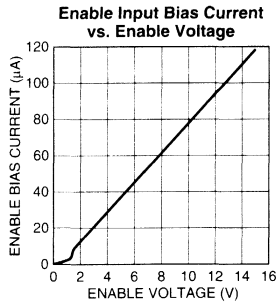
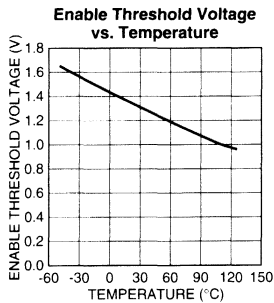
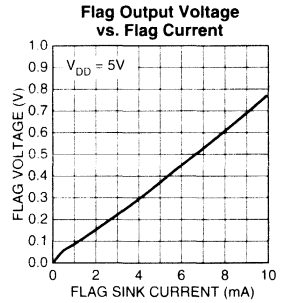
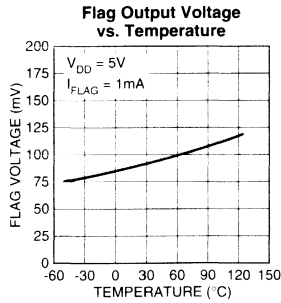
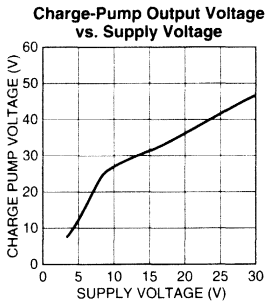
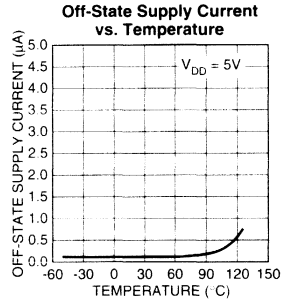
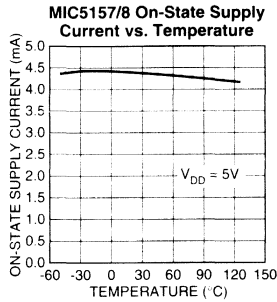
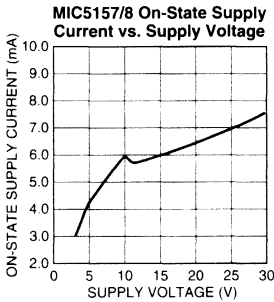
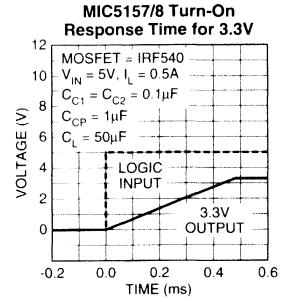
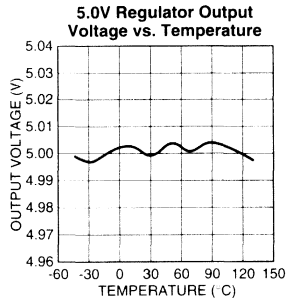
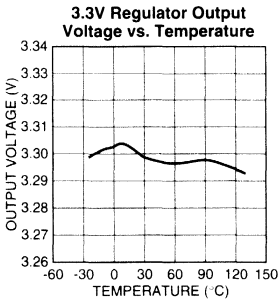

Block Diagram MIC5156

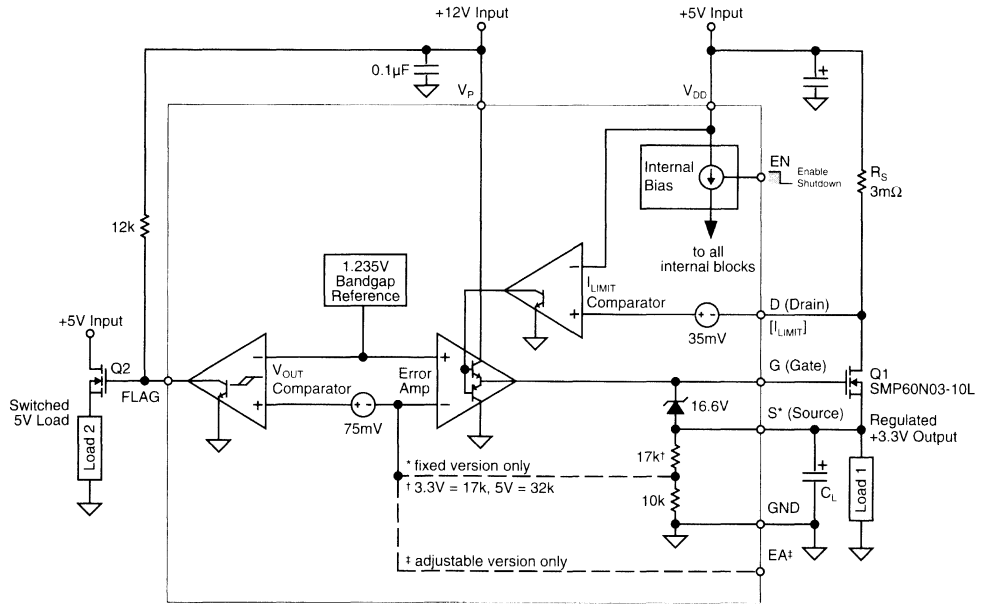

**Block Diagram with External Components
Fixed 3.3V Power Supply with 5.0V Load Switch**

Block Diagram MIC5157

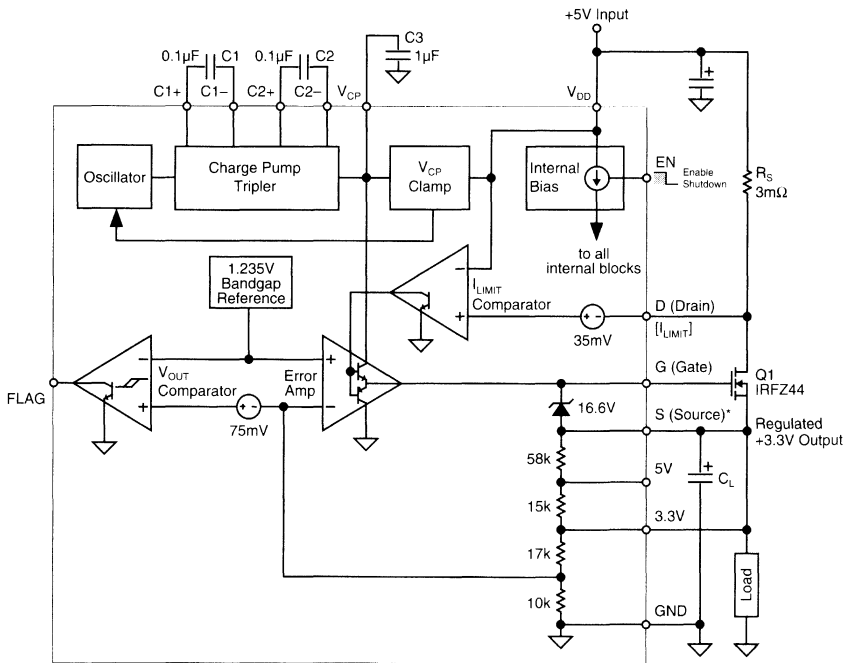

**Block Diagram with External Components
Fixed 3.3V 10A Power Supply**

Block Diagram MIC5158

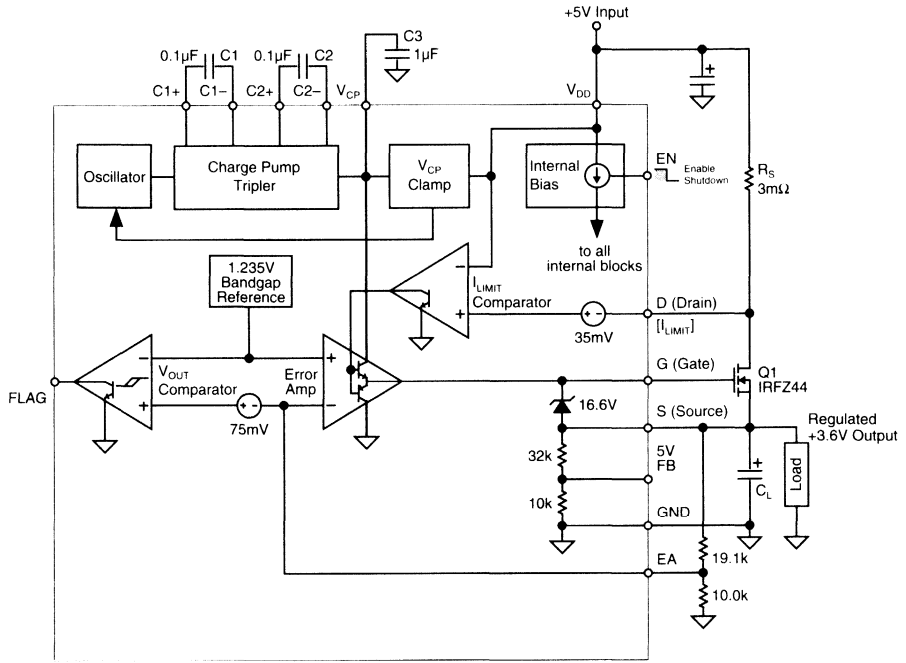

**Block Diagram with External Components
Adjustable Power Supply, 3.6V Configuration**

Functional Description

A *Super LDO Regulator* is a complete regulator built around Micrel's *Super LDO Regulator Controller*.

Refer to Block Diagrams MIC5156, MIC5157, and MIC5158.

Version Differences

The MIC5156 requires an external voltage for MOSFET gate drive and is available in 3.3V fixed output, 5V fixed output, or adjustable output versions. With 8-pins, the MIC5156 is the smallest of the Super LDO Regulator Controllers.

The MIC5157 and MIC5158 each have an internal charge pump which provides MOSFET gate drive voltage. The MIC5157 has a selectable fixed output of 3.3V, 5V, or 12V. The MIC5158 may be configured for a fixed 5V or adjustable output.

Enable (EN)

With at least 3.0V on V_{DD}, applying a TTL low to EN places the controller in shutdown mode. A TTL high on EN enables the internal bias circuit which powers all internal circuitry. EN must be pulled high if unused. The voltage applied to EN may be as high as 36V.

The controller draws less than 1µA in shutdown mode.

Gate Enhancement

The Super LDO Regulator Controller manages the gate-to-source enhancement voltage for an external N-channel

MOSFET (regulator pass element) placed between the supply and the load. The gate-to-source voltage may vary from 1V to 16V depending upon the supply and load conditions.

Because the source voltage (output) approaches the drain voltage (input) when the regulator is in dropout and the MOSFET is fully enhanced, an additional higher supply voltage is required to produce the necessary gate-to-source enhancement. This higher gate drive voltage is provided by an external gate drive supply (MIC5156) or by an internal charge pump (MIC5157 and MIC5158).

Gate Drive Supply Voltage (MIC5156 only)

The gate drive supply voltage must not be more than 14V above the supply voltage ($V_P - V_{DD} < 14V$). The minimum necessary gate drive supply voltage is:

$$V_P = V_{OUT} + V_{GS} + 1$$

where:

V_P = gate drive supply voltage

V_{OUT} = regulator output voltage

V_{GS} = gate-to-source voltage for full MOSFET gate enhancement

The error amplifier uses the gate drive supply voltage to drive the gate of the external MOSFET. The error amplifier output can swing to within 1V of V_P .

Charge Pump (MIC5157/5158 only)

The charge pump tripler creates a dc voltage across reservoir capacitor C3. External capacitors C1 and C2 provide the necessary storage for the stages of the charge pump tripler.

The tripler's approximate dc output voltage is:

$$V_{CP} \approx 3(V_{DD} - 1)$$

where:

V_{CP} = charge pump output voltage

V_{DD} = supply voltage

The V_{CP} clamp circuit limits the charge pump voltage to 16V above V_{DD} by gating the charge pump oscillator ON or OFF as required. The charge pump oscillator operates at 160kHz.

The error amplifier uses the charge pump voltage to drive the gate of the external MOSFET. It provides a constant load of about 1mA to the charge pump. The error amplifier output can swing to within 1V of V_{CP} .

Although the MIC5157/8 is designed to provide gate drive using its internal charge pump, an external gate drive supply voltage can be applied to V_{CP} . When using an external gate drive supply, V_{CP} must not be forced more than 14V higher than V_{DD} .

When constant loads are driven, the ON/OFF switching of the charge pump may be evident on the output waveform. This is caused by the charge pump switching ON and rapidly increasing the supply voltage to the error amplifier. The period of this small charge pump excitation is determined by a number of factors: the input voltage, the 1mA op-amp load, any dc leakage associated with the MOSFET gate circuit, the size of the charge pump capacitors, the size of the charge pump reservoir capacitor, and the characteristics of the input voltage and load. The period is lengthened by increasing the charge pump reservoir capacitor (C3). The amplitude is reduced by weakening the charge pump—this is accomplished by reducing the size of the pump capacitors (C1 and C2). If this small burst is a problem in the application, use a 10 μ F reservoir capacitor at C3 and 0.01 μ F pump capacitors

at C1 and C2. Note that the recovery time to repetitive load transients may be affected with small pump capacitors.

Gate-to-Source Clamp

A gate-to-source protective voltage clamp of 16.6V protects the MOSFET in the event that the output voltage is suddenly forced to zero volts. This prevents damage to the external MOSFET during shorted load conditions. Refer to "Charge Pump" for normal clamp circuit operation.

The source connection required by the gate-to-source clamp is not available on the adjustable version of the MIC5156.

Output Regulation

At start-up, the error amplifier feedback voltage (EA), or internal feedback on fixed versions, is below nominal when compared to the internal 1.235V bandgap reference. This forces the error amplifier output high which turns on external MOSFET Q1. Once the output reaches regulation, the controller maintains constant output voltage under changing input and load conditions by adjusting the error amplifier output voltage (gate enhancement voltage) according to the feedback voltage.

Out-of-Regulation Detection

When the output voltage is 8% or more below nominal, the open-collector FLAG output (normally high) is forced low to signal a fault condition. The FLAG output can be used to signal or control external circuitry. The FLAG output can also be used to shut down the regulator using the EN control.

Current Limiting

Super LDO Regulators perform constant-current limiting (not foldback). To implement current limiting, a sense resistor (R_S) must be placed in the "power" path between V_{DD} and D (drain).

If the voltage drop across the sense resistor reaches 35mV, the current limit comparator reduces the error amplifier output. The error amplifier output is decreased only enough to reduce the output current, keeping the voltage across the sense resistor from exceeding 35mV.

Application Information

MOSFET Selection

Standard N-channel enhancement-mode MOSFETs are acceptable for most Super LDO regulator applications.

Logic-level N-channel enhancement-mode MOSFETs may be necessary if the external gate drive voltage is too low (MIC5156), or the input voltage is too low, to provide adequate charge pump voltage (MIC5157/8) to enhance a standard MOSFET.

Circuit Layout

For the best voltage regulation, place the source, ground, and error amplifier connections as close as possible to the load. See figures (1a) and (1b).

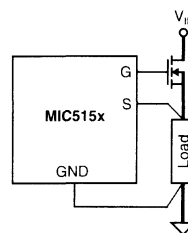

Figure 1a. Connections for Fixed Output

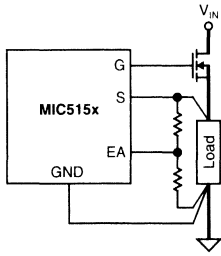
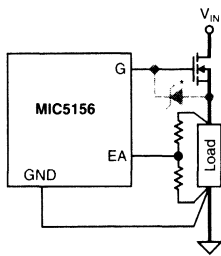

Figure 1b. Connections for Adjustable Output



* Optional 16V zener diode recommended in applications where V_G is greater than 18V

Figure 1c. MIC5156 Connections for Adjustable Output

MOSFET Gate-to-Source Protection

When using the adjustable version of the MIC5156, an external 16V zener diode placed from gate-to-source is recommended for MOSFET protection. All other versions of the Super LDO regulator controller use the internal gate-to-source clamp.

Output Voltage Configuration

Fixed Configurations

The MIC5156-3.3 and MIC5156-5.0 are preset for 3.3V and 5.0V respectively.

The MIC5157 operates at 3.3V when the 3.3V pin is connected to the S (source) pin; 5.0V when the 5.0V pin is connected to the S pin; or 12V if the 3.3V and 5.0V pins are open.

The MIC5158 operates at a fixed 5V (without an external resistive divider) if the 5V FB pin is connected to EA.

Adjustable Configurations

Micrel's MIC5156 [adjustable] and MIC5158 require an external resistive divider to set the output voltage from 1.235V to 36V. For best results, use a 10kΩ resistor for R2. See equation (1) and figure (2).

$$1) \quad R_1 = 1 \times 10^4 \left(\frac{V_{OUT}}{1.235} - 1 \right)$$

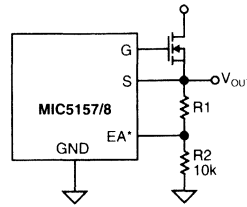

Figure 2. Typical Resistive Divider

Input Filter Capacitor

The Super LDO requires an input bypass capacitor for accommodating wide changes in load current and for decoupling the error amplifier and charge pump. A medium to large value low-ESR (equivalent series resistance) capacitor is best, mounted close to the device.

Output Filter Capacitor

An output filter capacitor may be used to reduce ripple and improve load regulation. Stable operation does not require a large capacitor, but for transient load regulation the size of the output capacitor may become a consideration. Common aluminum electrolytic capacitors perform nicely; very low-ESR capacitors are not necessary. Increased capacitance (rather than reduced ESR) is preferred. The capacitor value should be large enough to provide sufficient $I = C \times dV/dt$ current consistent with the required transient load regulation quality. For a given step increase in load current, the output voltage will drop by about $dV = I \times dt/C$, where I represents the increase in load current over time t. This relationship assumes that all output current was being supplied via the MOSFET pass device prior to the load increase. Small (0.01μF to 10μF) film capacitors parallel to the load will further improve response to transient loads.

Some linear regulators specify a minimum required output filter capacitance because the capacitor determines the dominant pole of the system, and thereby stabilizes the system. This is not the situation for the MIC5156/7/8; its dominant pole is determined within its error amplifier.

Current Limiting

Current sensing requires a low-value series resistance (R_S) between V_{DD} and D (drain). Refer to the typical applications. The internal current-limiting circuit limits the voltage drop across the sense resistor to 35mV. Equation (2) provides the sense resistor value required for a given maximum current.

$$2) \quad R_S = \frac{35\text{mV}}{I_{LIM}}$$

where:

R_S = sense resistor value

I_{LIM} = maximum output current

Most current-limited applications require low-value resistors. See *Application Hints 21 and 25* for construction hints.

Non-Current Limited Applications

For circuits not requiring current limiting, do not use a sense resistor between V_{DD} and D (drain). See figure (3). The controller will not limit current when it does not detect a 35mV drop from V_{DD} to D.

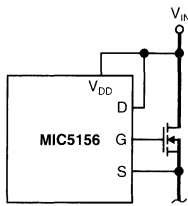

Figure 3. No Current Limit

3.3V Microprocessor Applications

For computer designs that use 3.3V microprocessors with 5V logic, the FLAG output can be used to suppress the 5V supply until the 3.3V output is in regulation. Refer to the external components shown with the MIC5156 Block Diagram.

SMPS Post Regulator Application

A Super LDO regulator can be used as a post regulator for a switch-mode power supply. The Super LDO regulator can provide a significant reduction in peak-to-peak ripple voltage.

High-Current Switch Application

All versions of the MIC5156/7/8 may be used for current-limited, high-current, high-side switching with or without voltage regulation. See figure (4a). Simply leave the "S" terminal open. A 16V zener diode from the gate to the source of the MOSFET protects the MOSFET from overdrive during fault conditions.

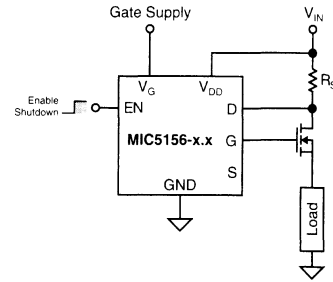

Figure 4a. High-Side Switch

If a MIC5157 or MIC5158 is used and is shutdown for a given time, the charge pump reservoir V_{CP} will bleed off. If recharging the reservoir causes an unacceptable delay in the load reaching its operating voltage, do not use the EN pin for on/off control. Instead, use the MIC5158, hold EN high to keep the charge pump in continuous operation, and switch the MOSFET on or off by overriding the error amplifier input as shown in figure (4b).

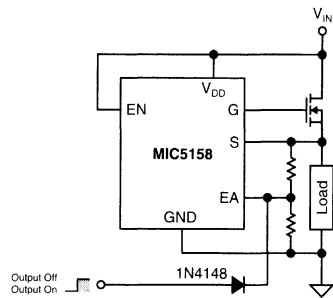

Figure 4b. Fast High-Side Switch

Battery Charger Application

The MIC5158 may be used in constant-current applications such as battery chargers. See figure (5). The regulator supplies a constant-current ($35\text{mV} \div R3$) until the battery approaches the float voltage:

$$V_{FL} = 1.235 \left(1 + \frac{R1}{R2} \right)$$

where:

V_{FL} = float voltage

At float voltage, the MOSFET is shut off. A trickle charge is supplied by R4.

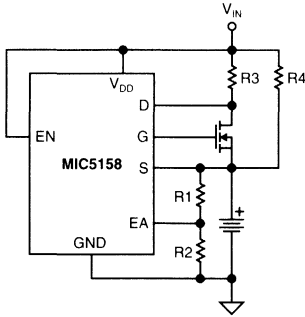

Figure 5. Battery Charger Concept

Uninterruptible Power Supply

The MIC5157 and two N-channel MOSFETs provide battery switching for uninterruptible power as shown in figure (6). Two MOSFETs are placed source-to-source to prevent current flow through their body diodes when switched off. The Super LDO regulator is continuously enabled to achieve fast battery switch-in. Careful attention must be paid to the ac-line monitoring circuitry to ensure that the output voltage does not fall below design limits while the battery is being switched in.

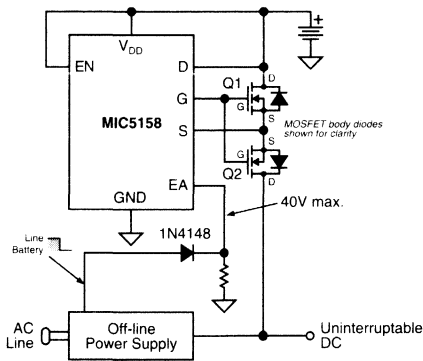

Figure 6. UPS Power Supply Concept

Switching Regulator Selection Guide

Device	Input Voltage Range	Preferred Topology	Maximum Switch Current	Control Mode	Maximum Frequency	Features				Package
						Front Edge Blanking	Shut-down or Sync (s)	Over Current Shutdown / Current Limit	Thermal Protection	
MIC2171 adjustable	3V to 40V	Boost	2.5A	Current	100kHz		•		•	TO-220 TO-263
MIC2172 adjustable	3V to 40V	Boost	1.25A	Current	100kHz		(s)	•	•	P-DIP SOIC
MIC3172 adjustable	3V to 40V	Boost	1.25A	Current	100kHz		•	•	•	CerDIP
MIC2177/78 3.3V, 5.0V, adjustable	4.5V to 20V	Buck	2.5A	Current	100kHz 200kHz		• (s) • (s)		• •	SOIC
MIC2570 2.85/3.3/5V selectable, adjustable	1.3V to 15V	Boost	130µA	Skip Mode	20kHz		(s)	•		SOIC
MIC2571 2.85/3.3/5V selectable, adjustable	0.9V to 15V	Boost	120µA	Skip Mode	20kHz		(s)	•		MM8™
LM2574 3.3V, 5.0V, 12V, adjustable	4V to 40V	Buck	0.5A	Voltage	52kHz		•	•	•	P-DIP SOIC
MIC4574 3.3V, 5.0V, adjustable	4V to 24V	Buck	0.5A	Voltage	200kHz		•	•	•	P-DIP SOIC
LM2575 3.3V, 5.0V, 12V, adjustable	4V to 40V	Buck	1A	Voltage	52kHz		•	•	•	TO-220 TO-263* P-DIP SOIC
MIC4575 3.3V, 5.0V, adjustable	4V to 24V	Buck	1A	Voltage	200kHz		•	•	•	TO-220 TO-263*
LM2576 3.3V, 5.0V, 12V, adjustable	4V to 40V	Buck	3A	Voltage	52kHz		•	•	•	TO-220 TO-263*
MIC4576 3.3V, 5.0V, adjustable	4V to 24V	Buck	3A	Voltage	200kHz		•	•	•	TO-220 TO-263*
MIC3832/33	8.3V to 21V	Current-Fed Push-Pull	external FET	Current or Voltage	500kHz	•	•	•		P-DIP CerDIP SOIC
MIC38x42/ 43/44/45	8.4V to 20V	Flyback	external FET	Current	500kHz			•		P-DIP CerDIP SOIC MM8™

* Surface Mount Power Package

Section 6: Package Information

Packaging for Automatic Handling	230
Tape & Reel Standards	230
Packages Available in Tape & Reel	230
Package Orientation	231
Package Dimensions	232
8-Pin Plastic DIP	232
14-Pin Plastic DIP	232
8-Pin SOIC	233
14-Pin SOIC	233
TO-92	234
SOT-223	234
SOT-23	235
SOT-143	235
SOT-23-5	236
8-Pin MSOP	236
3-Lead TO-220	237
5-Lead TO-220	237
5-Lead TO-220, Vertical Lead Bend	238
5-Lead TO-220, Horizontal Lead Bend	238
3-Lead TO-263	239
5-Lead TO-263	239
Typical 3-Lead TO-263 PCB Layout	240
Typical 5-Lead TO-263 PCB Layout	240
3-Lead TO-247	241
5-Lead TO-247	242

Packaging for Automatic Handling

Tape & Reel

Surface mount and TO-92 devices are available in tape and reel packaging. Surface mount components are retained in an embossed carrier tape by a cover tape. TO-92 device leads are secured to a backing tape by a cover tape. The tape is spooled on standard size reels.

Ammo Pack

TO-92 devices are also available in an “ammo pack.” TO-92 devices are secured to a backing tape by a cover tape and are fanfolded into a box. Ammo packs contain the same quantity, feed direction, and component orientation as a reel.

To order, specify the complete part number with the suffix “AP” (example†: MICxxxxZ AP).

Pricing

Contact the factory for price adder and availability.

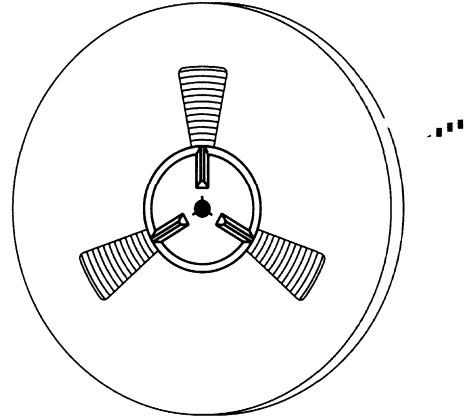

Typical 13" Reel
for Surface Mount Components

Tape & Reel Standards

Embossed tape and reel packaging conforms to:

- 8mm & 12mm Taping of Surface Mount Components for Automatic Handling, EIA-481-1*
- 16mm and 24mm Embossed Carrier Taping of Surface Mount Components for Automatic Handling, EIA-481-2*
- 32mm, 44mm and 56mm Embossed Carrier Taping of Surface Mount Components for Automatic Handling, EIA-481-3*

Packages Available in Tape & Reel

Part Number†	Package Description	Quantity / Reel	Reel Diameter	Carrier Tape Width	Carrier Tape Pitch
MICxxxxM T&R	8-lead SOIC	2,500	13"	12mm	8mm
	14-lead SOIC	2,500	13"	16mm	8mm
	16-lead SOIC	2,500	13"	16mm	8mm
MICxxxxWM T&R	16-lead wide SOIC	1,000	13"	16mm	12mm
	18-lead wide SOIC	1,000	13"	16mm	12mm
	20-lead wide SOIC	1,000	13"	24mm	12mm
	24-lead wide SOIC	1,000	13"	24mm	12mm
MICxxxxSM T&R	28-lead SSOP	1,000	13"	16mm	12mm
MICxxxxV T&R	20-lead PLCC	1,000	13"	16mm	12mm
	28-lead PLCC	500	13"	24mm	16mm
	44-lead PLCC	500	13"	32mm	24mm
MICxxxxM4 T&R	SOT-143	3,000	7"	8mm	4mm
MICxxxxM3 T&R	SOT-23	3,000	7"	8mm	4mm
MICxxxxM5 T&R	SOT-23-5	3,000	7"	8mm	4mm
MICxxxxS T&R	SOT-223	2,500	13"	16mm	12mm
MICxxxxU T&R	3-lead TO-263	750	13"	24mm	16mm
	5-lead TO-263	750	13"	24mm	16mm
MICxxxxZ T&R	TO-92	2,000	14¼"‡	—	1/2"

* Standards are available from: Electronic Industries Associations, EIA Standards Sales Department, tel: (202) 457-4966

† xxxx = base part number + temperature designation. Example: MIC5201BM T&R

‡ Cardboard reel

Package Orientation

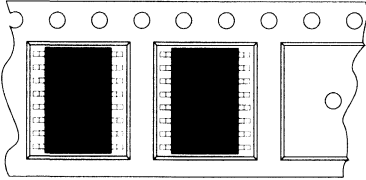

Typical SOIC Package Orientation
12mm, 16mm, 24mm Carrier Tape

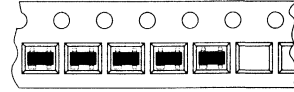

SOT-143 Package Orientation
8mm Carrier Tape

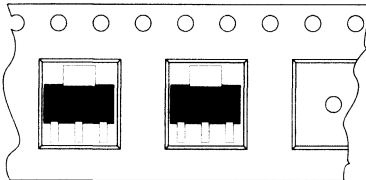

SOT-223 Package Orientation
16mm Carrier Tape

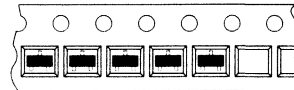

SOT-23 Package Orientation
8mm Carrier Tape

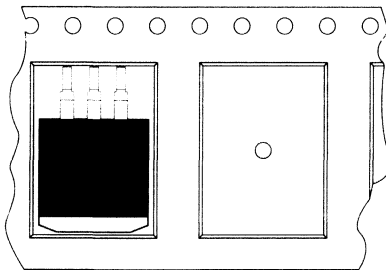

Typical TO-263 Package Orientation
24mm Carrier Tape

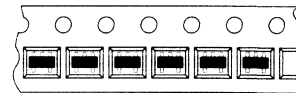

SOT-23-5 Package Orientation
8mm Carrier Tape

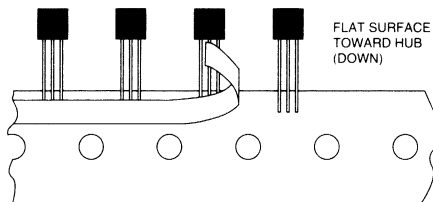

Typical TO-92 Package Orientation

Linear Regulator Packages

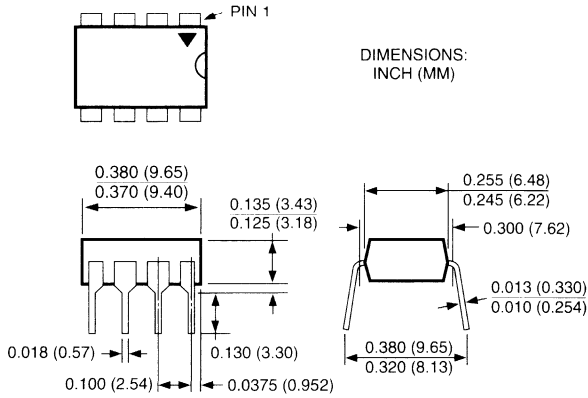

8-Pin Plastic DIP (N)

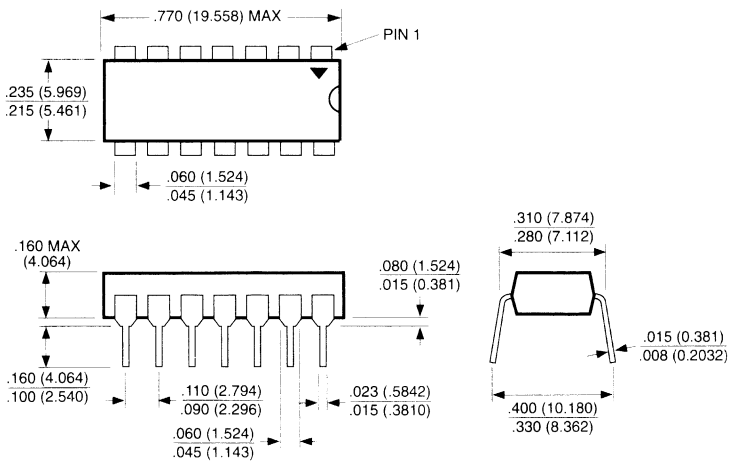

14-Pin Plastic DIP (N)

Note: Pin 1 is denoted by one or more of the following: a notch, a printed triangle, or a mold mark.

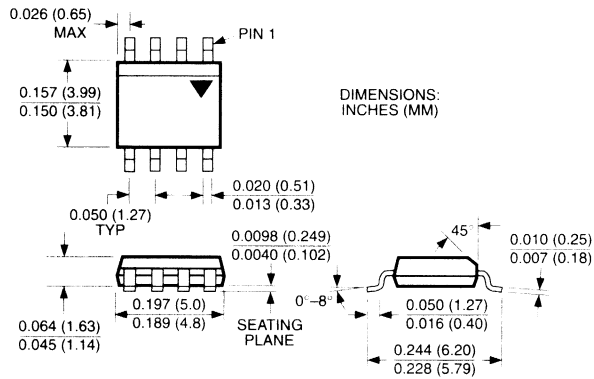

8-Pin SOIC (M)

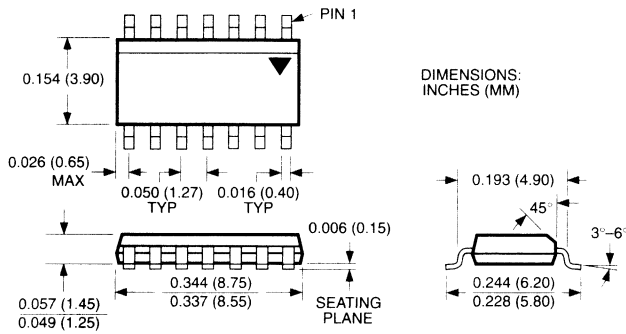

14-Pin SOIC (M)

Note: Pin 1 is denoted by one or more of the following: a notch, a printed triangle, or a mold mark.

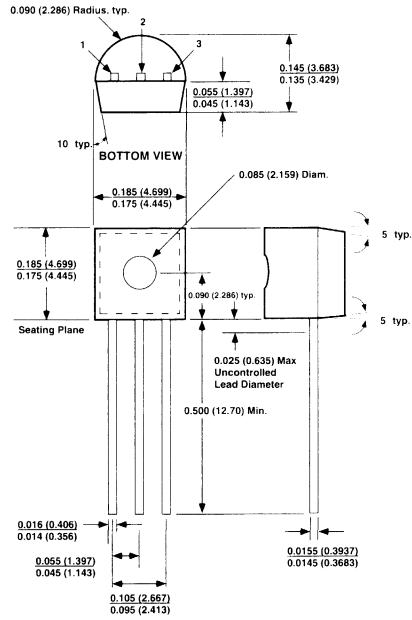

TO-92 (Z)

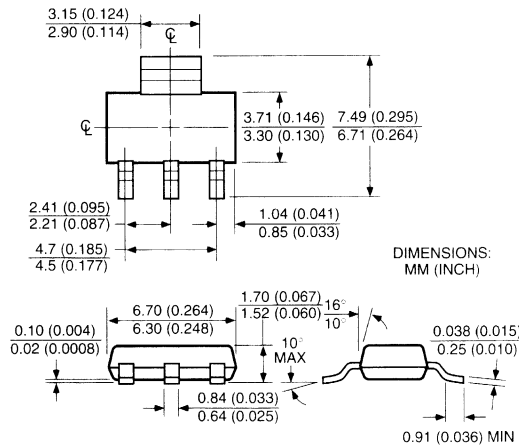

SOT-223 (S)

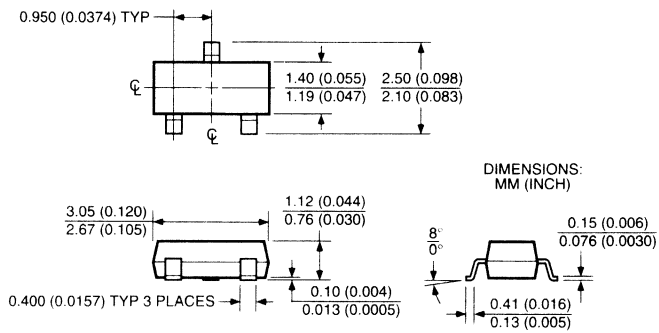

SOT-23 (M3)

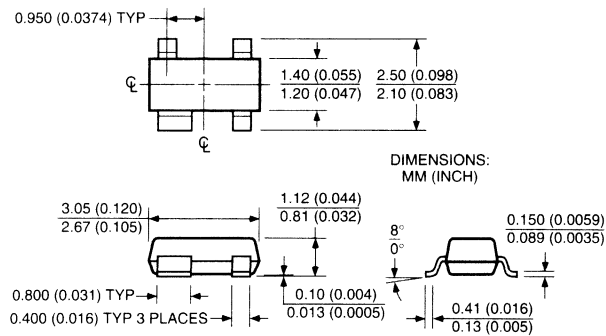

SOT-143 (M4)

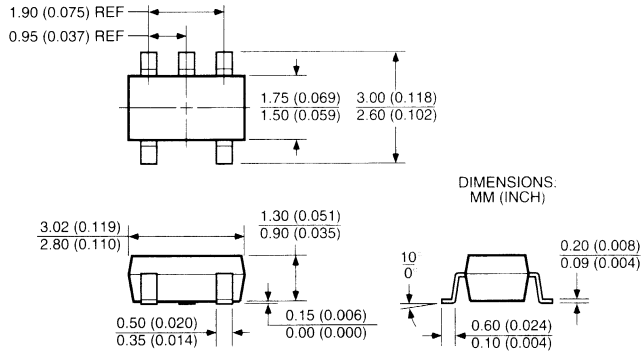

SOT-23-5 (M5)

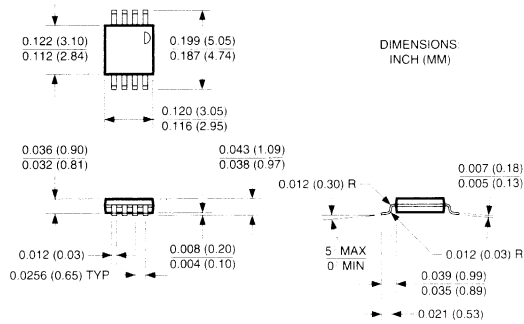

MSOP-8 (MM8)

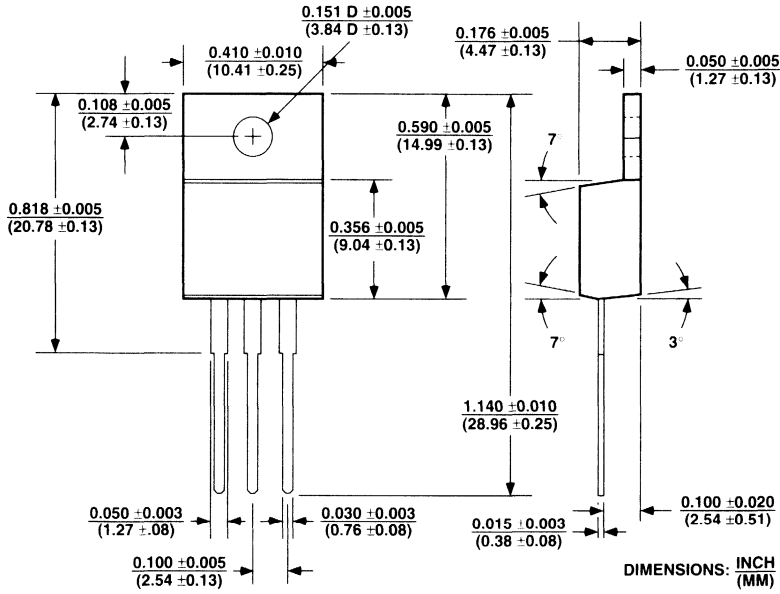

3-Lead TO-220 (T)

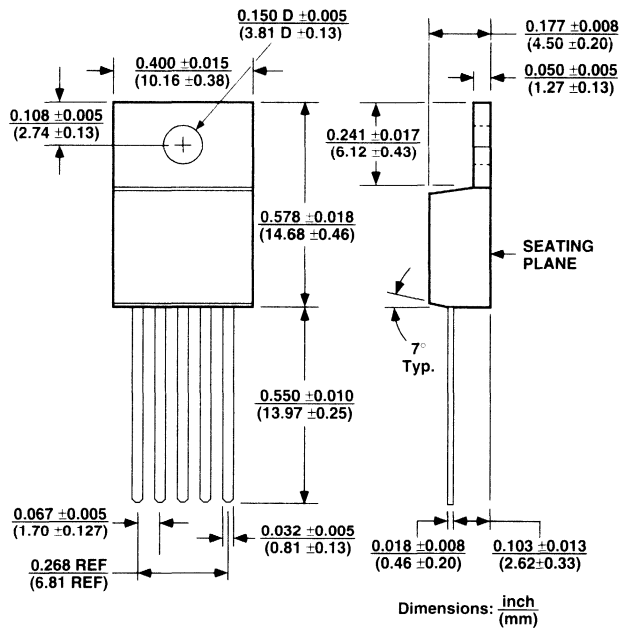

5-Lead TO-220 (T)

TO-220 Lead Bend Options *Contact Factory for Availability*

Part Number	Package	Lead Form
MICxxxxyT	5-lead TO-220	none (straight)
MICxxxxyT-LB03	5-lead TO-220	vertical, staggered leads, 0.704" seating
MICxxxxyT-LB02	5-lead TO-220	horizontal, staggered leads

MICxxxx = base part number, y = temperature range, T = TO-220

* Leads not trimmed after bending.

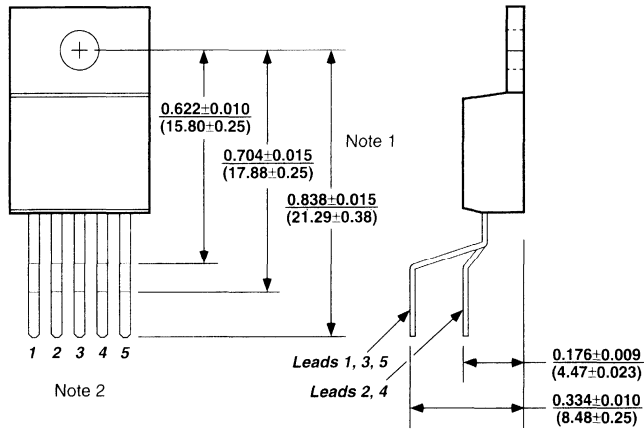

TO-220 Vertical Lead Bend Option -LB03

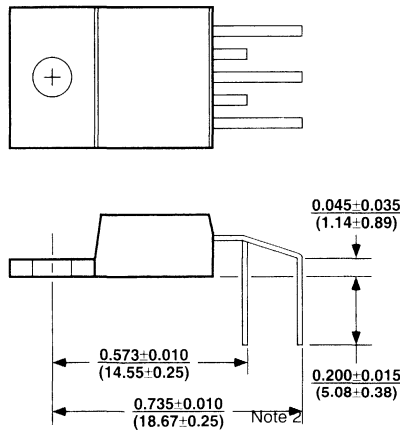

TO-220 Horizontal Lead Bend Option -LB02

Note 1. Lead protrusion through printed circuit board subject to change.

Note 2. Lead ends may be curved or square.

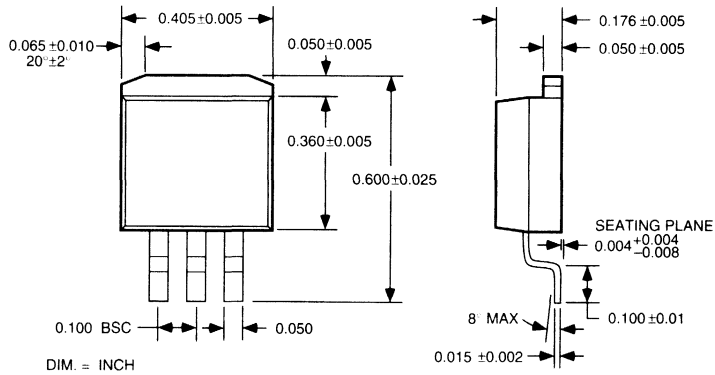

3-Lead TO-263 (U)

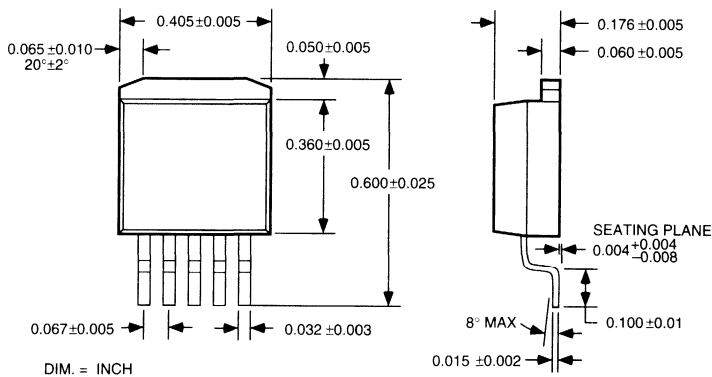

5-Lead TO-263 (U)

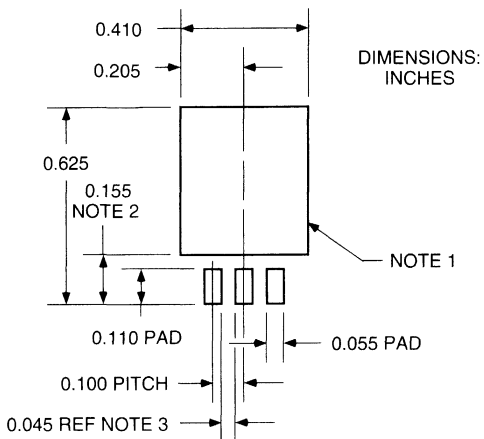

- NOTE 1: PAD AREA MAY VARY WITH HEAT SINK REQUIREMENTS
- NOTE 2: MAINTAIN THIS DIMENSION
- NOTE 3: AIR GAP (REFERENCE ONLY)

Typical 3-Lead TO-263 PCB Layout

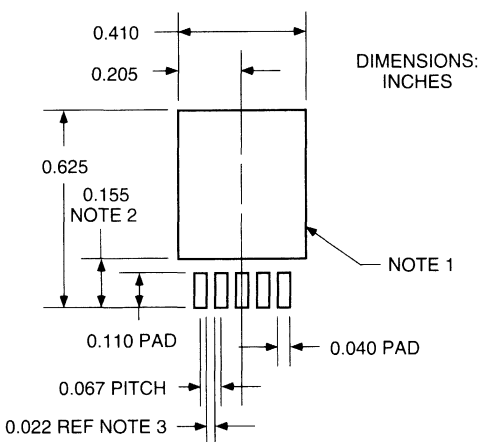

- NOTE 1: PAD AREA MAY VARY WITH HEAT SINK REQUIREMENTS
- NOTE 2: MAINTAIN THIS DIMENSION
- NOTE 3: AIR GAP (REFERENCE ONLY)

Typical 5-Lead TO-263 PCB Layout

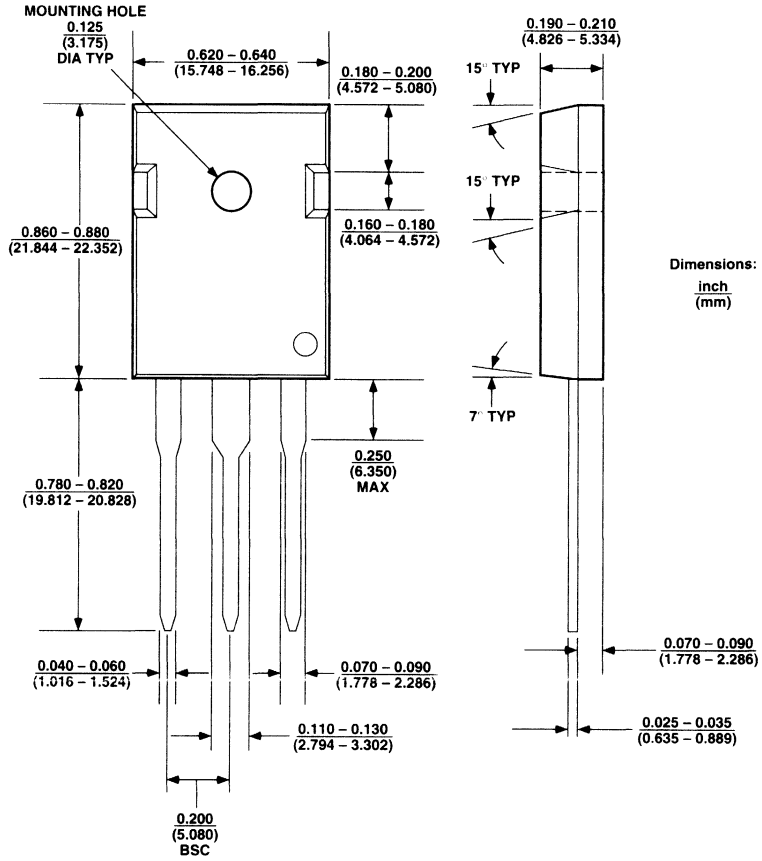

3-Lead TO-247 (WT)

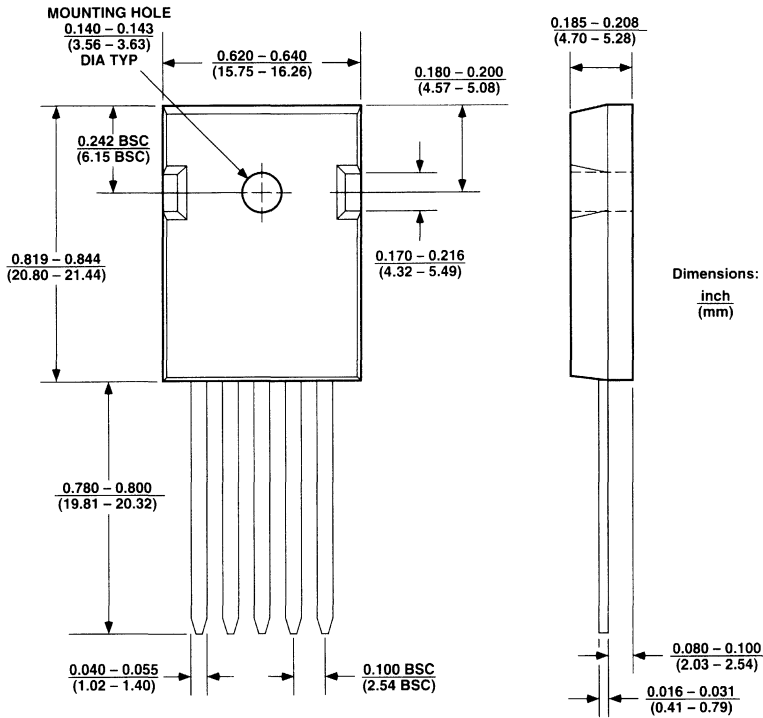

5-Lead TO-247 (WT)

Section 7. Appendices

List of Appendices

Appendix A. Table of Standard 1% Resistor Values	244
Appendix B. Table of Standard $\pm 5\%$ and $\pm 10\%$ Resistor Values	245
Appendix C. LDO SINK for the HP 48 Calculator	246

Appendix A. Table of Standard 1% Resistor Values

100	215	464
102	221	475
105	226	487
107	232	499
110	237	511
113	243	523
115	249	536
118	255	549
121	261	562
124	267	576
127	274	590
130	280	604
133	287	619
137	294	634
140	301	649
143	309	665
147	316	681
150	324	698
154	332	715
158	340	732
162	348	750
165	357	768
169	365	787
174	374	806
178	383	825
182	392	845
187	402	866
191	412	887
196	422	909
200	432	931
205	442	953
210	453	976

This table shows three significant digits for standard $\pm 1\%$ resistor values. These significant digits are multiplied by powers of 10 to determine resistor values. For example, standard resistor values are 0.100 Ω , 1.00 Ω , 1.00k Ω , 1.00M Ω , 100M Ω , etc.

Appendix B. Table of Standard $\pm 5\%$ and $\pm 10\%$ Resistor Values

($\pm 10\%$ values in bold)
10
11
12
13
15
16
18
20
22
24
27
30
33
36
39
43
47
51
56
62
68
75
82
91

This table shows two significant digits for the standard $\pm 5\%$ and $\pm 10\%$ resistor values. These significant digits are multiplied by powers of 10 to determine resistor values. For example, standard resistor values are 0.1 Ω , 1.0 Ω , 1.0k Ω , 1.0M Ω , 10M Ω , etc.

Appendix C. LDO SINK for the HP 48 Calculator

The following program, written for the HP 48 calculator, will calculate all power dissipation and heat sink related parameters and ease your design optimization process. It will also graph the resulting heat sink characteristics versus input voltage. The program listing follows the user information. It was written on a HP 48S and runs on both the "S" and the 48G(X) version of the calculator. If you would like to receive the program electronically, send e-mail to Micrel at apps@micrel.com and request program "LDO SINK for the HP48". It will be sent via return e-mail.

Using LDO SINK

After loading the program, change to the directory containing it. In the example shown, it is loaded into {HOME MICREL LDO SINK}.

The first screen you will see looks like this:

```
{ HOME MICREL LDO SINK }
4:
3:
2:
1:
FIRST DTIN REVW GRAF θSA HELP
```

Pressing the white HELP function key displays a screen of on-line help.

```
Regulator Thermals
HELP file
Press FIRST to begin.
DTIN is DaTaINput
RE VW is REView data
GRA F shows θsa
SOLVR solves numericly
FIRST DTIN REVW GRAF θSA HELP
```

Pressing either FIRST or DTIN will start the program and prompt you for the most commonly changed data. REVW brings up a list of data already entered. GRAF draws the heat sink θ_{SA} versus input

voltage. SOLVR begins the built-in solve routine that allows you to solve for any variable numerically.

Let's run the program. Press FIRST to begin. Your screen shows:

```
Regulator Thermals
Enter data, then press
← CONT
FIRST DTIN REVW GRAF θSA HELP
```

After a brief pause, the output voltage prompt appears:

```
Vout=3.30?
4:
3:
2:
1: 3.30
FIRST DTIN REVW GRAF θSA HELP
```

Enter a new number and press ← CONT to continue. If the data previously entered is still correct, you may simply press ← CONT to retain it. Proceed through the list, entering data as prompted and pressing ← CONT to continue. You will be prompted for

- Vout the desired regulator output voltage
- Iout regulator output current
- Vmax the maximum input voltage
- Vmin the lowest input voltage (used only by the graphing routine)
- θ_{jc} thermal resistance, junction to case (from the device data sheet)
- θ_{cs} thermal resistance from the case to the heat sink

After these data are entered, the Review screen appears and confirms your entries.

```

==Regulator Thermals==
Output V: 3.30
Output I: 3.00
Vin:      5.50
θjc:     2.00
θcs:     0.50
Ambient Temp: 50.00°C
GRAF SOLVR REVW VMAX VMIN NEXT
    
```

Ambient temperature was not on the list of prompted data. If you wish to change it, press ON (CANCEL) followed by the white NEXT key. Enter the ambient temperature followed by the white TA key. Press the white NEXT key twice to get to the calculation menu. Another variable used but not prompted for is T_{JM}, the maximum junction temperature for the regulator.

You may now press GRAF to calculate and view the θ_{sa} versus V_{in} graph, or SOLVR to start the numerical solve routine. If we press GRAF, the following is displayed:

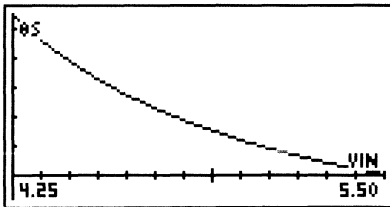

This shows the thermal resistance of the heat sink as the input voltage varies from a low of 4.25V to a high of 5.50V. Pressing ON/CANCEL at this time returns you to the stack display, with θ_{sa} at the maximum input voltage displayed.

NOTE: the x-axis is shown beneath the HP 48 graph menu. Press the minus (-) key to toggle between the menu and axis display. Pressing TRACE followed by (X, Y) puts the HP 48 in trace mode and displays the coordinate values of the plot. Press the cursor keys to move around the plot and show voltage (v) versus θ_{sa} and displays the coordinate values of the plot. Press the cursor keys to move around the plot and show voltage (v) versus θ_{sa} (y-axis). Here the cursor has been moved to a V_{in} of 5.00V and shows a required maximum θ_{sa} of 11.79 C/W.

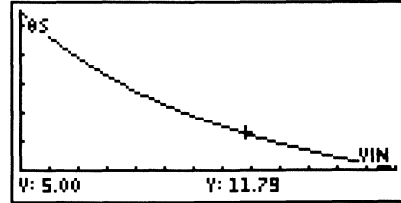

Pressing ON/CANCEL returns you to the calculation menu. If you hit the white SOLVR key, the HP 48 Solve application is started and you may solve for any of the variables numerically.

```

EQ: 'θsa=(TJM-TA)/(( ...
4:
3:
2:
1:
θsa TJM TA Vin VO IO
    
```

Enter a value and press its white function key to modify variables. Use the HP 48 NXT key to access θ_{jc} and θ_{cs}. Solve for a variable by pressing the ← key followed by the variable's white function key. Press → VIEW (HP 48G) or ← REVIEW (HP 48S) to review all variable values.

Program Listing

For those without the HP 48 compatible serial cable or e-mail access, here is the program listing for LDO SINK. "SINK" is installed as a directory. It is 1948.5 bytes long and has a checksum of # 35166d.

```

%%HP: T(1)A(D)F(.);
DIR
  FIRST
  < DTIN
  >
  DTIN
  < CLLCD
  "Regulator Thermals
  Enter data, then press
  ← CONT"
  1 DISP 3 WAIT CLEAR
  VO "Vout=" VO + "?"
  + PROMPT 'VO' STO
  CLEAR IO "Iout=" IO
    
```

```

+ "?" + PROMPT 'IO'
STO CLEAR VMAX
"Vmax=" VMAX + "?"
+ PROMPT 'VMAX' STO
CLEAR VMIN "Vmin="
VMIN + "?" + PROMPT
'VMIN' STO CLEAR
θJC "θjc=" θJC +
"?" + PROMPT 'θJC'
STO CLEAR θCS
"θcs=" θCS + "?" +
PROMPT 'θCS' STO
REVV
»
REVV
« CLLCD
"==Regulator Thermals=="
1 DISP "Output V: "
VO + 2 DISP
"Output I: " IO + 3
DISP "Vin: "
VMAX VMAX 'VIN' STO
+ 4 DISP
"Ambient Temp: " TA
+ "°C" + 7 DISP
"θjc: " θJC +
5 DISP "θcs: "
θCS + 6 DISP NEX1
TMENU 3 FREEZE
»
GRAF
« CLLCD
"Regulator Thermals
Graphing θsa vs Vin"
2 FIX 1 DISP '(TJM-
TA)/((1.02*VIN-VO)*
IO)-θJC-θCS' STEQ
FUNCTION 'VIN'
INDEP VMIN VMAX
XRNG VMIN VMAX
'VIN' STO EQ EVAL
R+C AXES { "Vin"
"θS" } AXES AUTO
ERASE DRAW DRAX
LABEL VMAX 'VIN'
STO EQ EVAL 1 TRNC
"θsa(min)" →TAG
PICTURE
»
θsa 1.19549150037
HELP

```

```

« CLLCD
"Regulator Thermals
HELP file
Press FIRST to begin.
DTIN is DaTaINput
REVV is REvIEW data
GRAF shows θsa
SOLVR solves numericly"
1 DISP 3 FREEZE
»
NEX1 { GRAF {
"SOLVR"
« HS STEQ 30
MENU
» } REVW VMAX
VMIN { "NEXT"
« NEX2 TMENU
» } }
NEX2 { VO IO VIN
TA TJM { "NEXT"
« NEX3 TMENU
» } }
NEX3 { θJC θCS ""
"" HELP { "NEXT"
« NEX1 TMENU
» } }

```

Variables

```

θJC 2
VMAX 5.5
VMIN 4.25
HS 'θsa=(TJM-TA)/
((1.02*VIN-VO)*IO)-
θJC-θCS'
PPAR {
(4.25,6.47110814478)
(5.5,22.6889168766)
VIN 0 {
(4.25,8.5864745011)
"Vin" "θS" }
FUNCTION Y {
EQ 'θsa=(TJM-TA)/
((1.02*VIN-VO)*IO)-
θJC-θCS'
θCS .5
IO 6
VO 3.3
VIN 5.5
TJM 125
TA 75
END

```

Section 8. Low-Dropout Voltage Regulator Glossary

Dropout (Voltage)	The minimum value of input-to-output voltage differential required by the regulator. Usually defined as the minimum additional voltage needed before the regulator's output voltage dips a certain amount below its normal in-regulation value, and regulation ceases. For example, if an output of 5V is desired, and the regulator has a dropout voltage (V_{DO}) of 0.3V, then at least 5.3V is required on the regulator input.
Enable	Digital input allowing ON/OFF control of the regulator. Also called "control" or " <u>shutdown</u> " (see Shutdown, below). Enable denotes positive logic—a high level enables the regulator.
Error Flag	A digital indicator that signals an error condition. Micrel LDOs have optional error flags that indicate the output is not in-regulation because of overcurrent faults, low input voltage faults, or excessively high input voltage faults.
Forced Convection	Heat flow away from a source, such as a regulator or heat sink, aided by forced air flow (usually provided by a fan). See <u>Natural Convection</u> .
Ground Current	The portion of regulator supply current that flows to ground instead of to the load. This is wasted current and should be minimized. Ground current is composed of <u>quiescent current</u> and base current. (See quiescent current, below). Base current is reduced by using Micrel's proprietary <u>Super β PNP™</u> process, giving Micrel LDOs the best performance in the industry.
Heat Sink	A conductor of heat attached to a regulator package to increase its power handling ability.
LDO	<u>Low DropOut</u> . Jargon for a linear, low drop out voltage regulator.
Line Transient	The change in regulator output caused by a sudden change in input voltage.
Linear Regulator	A regulator that uses linear control blocks and pass elements, as opposed to a <u>switching regulator</u> . Linear regulators are simple to use, require no magnetic components, and produce extremely clean, well regulated output. Their efficiency varies greatly with input voltage. Linear regulators have approximately the same <i>output current</i> as <i>input current</i> .
Load Dump	An automotive industry term for a large positive voltage spike that is created when the alternator's load is suddenly disconnected due to a system fault. The automotive industry considers an electronic component "load dump protected" if it can survive a +60V transient for at least 100msec.

Load Transient	The change in output voltage caused by a sudden change in load current.
Natural Convection	Heat flow away from a hot source, such as a regulator or heat sink, unaided by a fan. See Forced Convection .
Overtemperature Shutdown	A protection feature of Micrel regulators that disables the output when the regulator temperature rises above a safe threshold.
Overvoltage Shutdown	A protection feature of some Micrel regulators that disables the output when the input voltage rises above a certain threshold.
Post Regulator	A method of reducing output ripple by following a switching regulator with a linear regulator.
Quiescent Current	Current used by the regulator for housekeeping. Quiescent current does not contribute to the load and should be minimized. In a PNP LDO, ground current equals quiescent when the output current is 0mA.
Reverse Battery Protection	A regulator with reverse battery protection will not be destroyed if the input supply polarity is backwards. A related feature allows Micrel LDOs to effectively act as an “ideal” diode, protecting the load from this backward polarity condition, or allowing the outputs of different output-voltage regulators to be “ORed” without damage.
Shutdown	Digital input allowing ON/OFF control of the regulator. Also called “control” or “ enable ”. Shutdown denotes negative logic—a logic low enables the regulator.
Super Beta PNP™	Micrel's trademarked name for a power semiconductor process combining good high voltage operation with high transistor beta (current gain). Compared to standard power PNP transistor betas of only 8 to 10, Super Beta PNP-processed transistors feature nominal betas of 50 to 100. LDO efficiency depends on high beta: efficiency at high load current is proportional to the PNP pass transistor beta. High beta means low ground current which improves efficiency; this allows high output with less wasted power than other monolithic linear regulators, either standard or low-dropout.
Super LDO	The MIC5156, MIC5157, and/or MIC5158. Linear regulator controllers that drive external N-channel power MOSFETs. Output current and dropout voltage are dependant upon the MOSFET employed. Using the Super LDO with large MOSFETs allow extremely low dropout voltage and very high output currents.
Switching Regulator	Also known as SMPS (Switch Mode Power Supply). Voltage regulator topology that uses ON/OFF switching to efficiently regulate voltage. Magnetics (inductors and/or transformers) are generally used. Ideal switching regulators have nearly the same <i>output power</i> as <i>input power</i> , resulting in very high efficiency. Switching regulators usually have inferior output characteristics, such as noise and voltage regulation, compared to linear regulators.

Section 9. References

Thermal Information

Micrel Databook, Micrel Inc., San Jose, CA. Tel: + 1 (408) 944-0800

MIL-STD-275E: *Printed Wiring for Electronic Equipment*. (31 December 1984)

Innovative Thermal Management Solutions, Wakefield Engineering, 60 Audubon Road, Wakefield, MA 01880. Tel: + 1 (617) 245-5900

Spoor, Jack: *Heat Sink Applications Handbook*, 1974, Aham, Inc.

Technical Reports and Engineering Information Releases, Thermalloy Inc., Dallas Texas. Tel: + 1 (214) 243-4321

Thermal Management, AAVID™ Engineering, Inc., Laconia, NH. Tel: + 1 (603) 528-3400

Thermal Management Solutions, Thermalloy Inc., Dallas Texas. Tel: + 1 (214) 243-4321

4-Lead Resistor Manufacturers

Dale Electronics, Columbus, NE. Tel: + 1 (402)563-6506

Vishay Resistors, Malvern, PA. Tel: + 1 (215) 644-1300

Section 10. Index

A

Accuracy. *See* Voltage accuracy

B

Bandgap. *See* References (voltage)

C

Capacitors 25
 effective series resistance 25
 Cellular telephones 47
 Computer power supplies 39
 Copper wire resistance 70
 Current source 37
 Super LDO 37
 using op amps 37

D

Design issues 2
 Dropout 249
 Dropout voltage 2

E

Efficiency 3, 32
 Enable pin 249
 Error Flag 249

F

Filter capacitor. *See* Capacitors
 Forced Convection 249

G

Glossary 249
 Ground current 2, 249
 Ground loop 26

H

Heat sink 27, 48, 249
 charts for high current regulators 51
 for surface mount packages 57
 mounting multiple devices 55
 reading manufacturer's graphs 53
 selection 53
 size reduction via power sharing resistor 54
 High input voltage operation 34

I

Inrush surge, controlling 34
 Isolation 47

K

Kelvin sensing 26, 70

L

Layout 25
 Lead bending 27
 Lead forming. *See* Lead bending
 Line transient 249
 Linear regulator 249
 Linear regulator benefits 1
 Load dump 249
 Load transient 250
 LP2950/2951 99

M

MIC29150/29300/29500/29750 Series 178
 MIC2920A/29201/29202/29203/29204 152
 MIC29310/29312 193
 MIC2937A/29371/29372/29373 161
 MIC2940A/2941A 170
 MIC2950/2951 100
 MIC29510/29512 201
 MIC2954 142
 MIC29710/29712 209
 MIC5156/5157/5158 217
 MIC5200 87
 MIC5201 136
 MIC5202 93
 MIC5203 81
 MIC5205 115
 MIC5206 122
 MIC5207 129
 MIC5230 76
 Microprocessor supplies 39
 accuracy 43
 dropout requirement 39
 heat sink calculations 52
 multiple output 44
 using a current-booster MIC2951 41
 using a monolithic LDO 40
 using the MIC5156 40
 using the MIC5158 41

N

- Natural convection 250
- Noise 32
 - effects on VCOs 46
 - reference. *See* References (voltage): noise

O

- Overtemperature shutdown 250
- Overvoltage shutdown 64, 250

P

- Packages 64
- Packaging
 - 14-Pin Plastic DIP (N) 232
 - 14-Pin SOIC (M) 233
 - 3-Lead TO-220 (T) 237
 - 5-Lead TO-220 (T) 237
 - 8-Pin MSOP (MM8) 236
 - 8-Pin Plastic DIP (N) 232
 - 8-Pin SOIC (M) 233
 - SOT-143 (M4) 235
 - SOT-223 (S) 234
 - SOT-23 (M3) 235
 - SOT-23-5 (M5) 236
 - TO-220 Horizontal Lead Bend Option -LB02 238
 - TO-220 Vertical Lead Bend Option -LB03 238
 - TO-247 (WT) 241, 242
 - TO-263 (U) 239
 - TO-263 PCB Layout 240
 - TO-92 (Z) 234
- Packaging for Automatic Handling 230
 - package orientation 231
 - Tape & Reel 230
- Portable equipment 46
- Post regulator 250
- Power dissipation by package type, graph 7

Q

- Quiescent current 250

R

- References (bibliography) 251
- References (voltage) 28, 29, 32
 - noise 32
- Resistance
 - Copper Wire (table) 70
 - Printed Circuit Board (table) 71
- Resistors
 - Standard $\pm 5\%$ and $\pm 10\%$ Value Table 245
 - Standard 1% Value Table 244
- Reverse battery protection 250

S

- Sequencing multiple supplies 45, 47
- Shutdown 250
- Sleep mode 47
- Split supplies, problems with 33
- Stability 32, 65
- Super β PNP™ regulators
 - dropout voltage 62
 - family list 5, 61
 - ground current 63
 - overvoltage shutdown 64
 - paralleling 65
 - reverse-polarity characteristics 63
 - simplified schematic 62
- "Super LDO" 67, 250
 - comparison to monolithics 68
 - current limit 70
 - current limit sense resistor 70
 - data sheet 217
 - unique applications 68
- Super β PNP™ regulators 61
- Switching regulators 250
 - comparison to LDO 4

T

- Thermals 48
 - calculator program 52, 246
 - definition of parameters 48
 - electrical analogy 48
 - example calculations 52
 - heat flow 49
 - maximum junction temperature 50
 - primer 48
 - thermal resistance 49
- Transients 28
 - improving response 42
- Troubleshooting guide 60

V

- Voltage accuracy 26, 28, 29

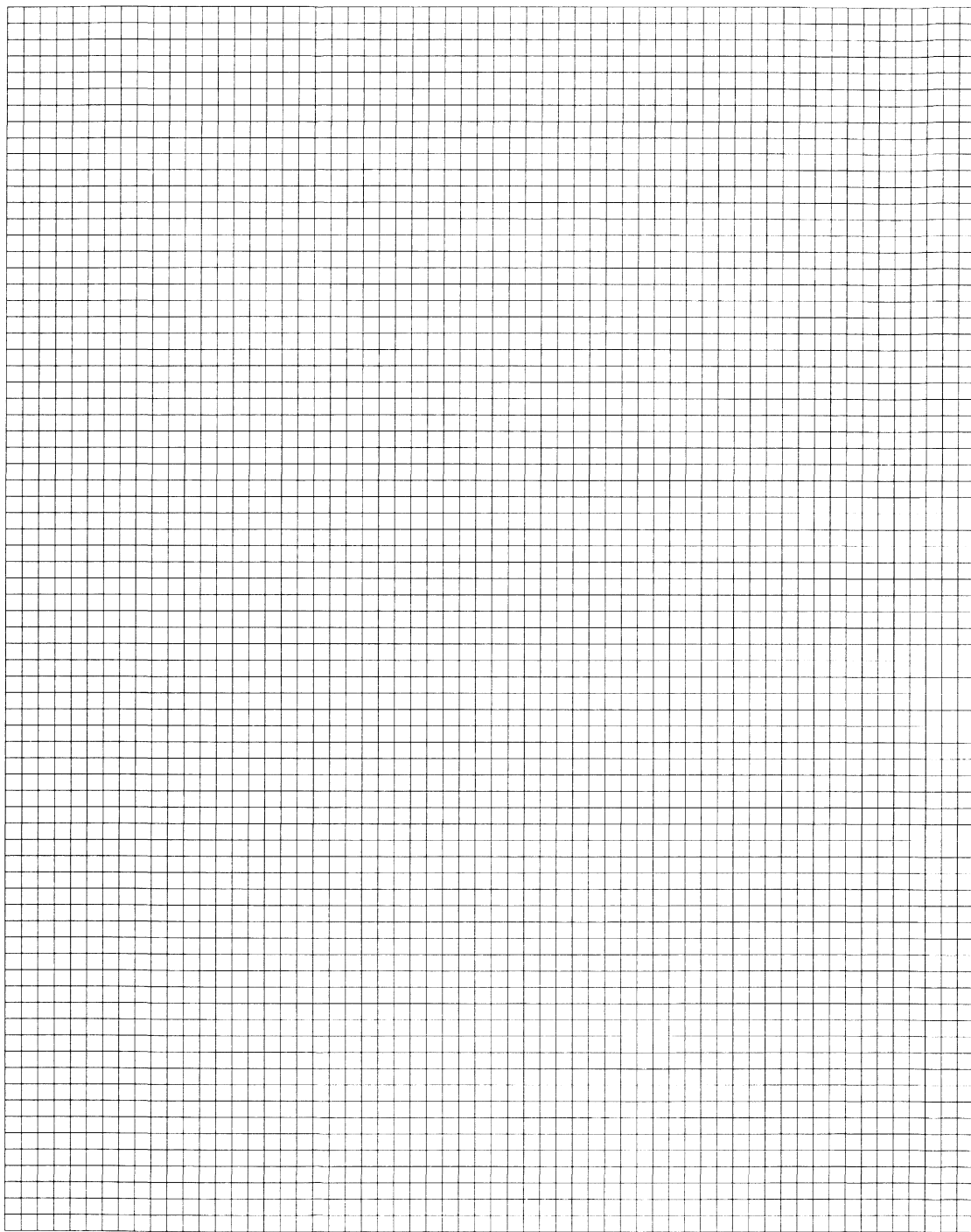

Section 11. Worldwide Sales Force

Micrel Sales Offices

**MICREL SEMICONDUCTOR
CORPORATE OFFICE**

1849 Fortune Dr. Tel: (408) 944-0800
San Jose, CA 95131 Fax: (408) 944-0970

MICREL WESTERN AREA SALES OFFICE

Suite 67
1850 West Orangethorpe Ave. Tel: (714) 879-9710
Fullerton, CA 92833 Fax: (714) 879-3922

MICREL EASTERN AREA SALES OFFICE

119 Westgate Rd. Tel: (617) 237-4628
Wellesley, MA 02181 Fax: (617) 237-4145

MICREL CENTRAL AREA SALES OFFICE

Suite 450C-199
120 S. Denton Tap. Tel: (972) 393-3603
Coppell, TX 75019 Fax: (972) 393-9186

**MICREL DISTRIBUTOR SALES MANAGEMENT
OFFICE**

81 New St. Tel: (516) 673-2204
Huntington, NY 11743 Fax: (516) 673-2987

MICREL EUROPE TECHNICAL CENTER

Clere House
21 Old Newtown Road Tel: + 44 (1635) 524455
Newbury RG 147DP Fax: + 44 (1635) 524466
United Kingdom

U.S. Sales Representatives

ALABAMA

CSR Electronics
Suite 931
303 Williams Ave.
Huntsville, AL 35801

Tel: (205) 533-2444
Fax: (205) 536-4031

ALASKA

contact factory

Tel: (408) 944-0800

ARIZONA

O'Donnell Associates Southwest, Inc.

Suite 1026
2432 West Peoria Ave.
Phoenix, AZ 85029

Tel: (602) 944-9542
Fax: (602) 861-2615

ARKANSAS

Kruvand Associates Inc.

Suite 113
1202 Richardson Dr.
Richardson, TX 75080

Tel: (972) 437-3355
Fax: (972) 680-8854

CALIFORNIA (NORTHERN)

Trinity Technologies, Inc.

1261 Oakmead Pkwy.
Sunnyvale, CA 94086

Tel: (408) 733-9000
Fax: (408) 733-9970

CALIFORNIA (SOUTHERN)

CK Associates

Suite 102
8333 Clairmont Mesa Blvd.
San Diego, CA 92111

Tel: (619) 279-0420
Fax: (619) 279-7650

Select Electronics

Bldg. F, Suite 106
14730 Beach Blvd.
La Mirada, CA 90638

Tel: (714) 739-8891
Tel: (310) 921-5159
Fax: (714) 739-1604

COLORADO

Lindberg Company

Suite 21
5701 East Evans Ave.
Denver, CO 80222

Tel: (303) 758-9033
Fax: (303) 758-5863

CONNECTICUT (EXCEPT FAIRFIELD COUNTY)

3D Sales

Suite 205
5 Burlington Woods
Burlington, MA 01803

Tel: (617) 229-2999
Fax: (617) 229-2033

CONNECTICUT (FAIRFIELD COUNTY)

Harwood Associates

25 High St.
Huntington, NY 11743

Tel: (516) 673-1900
Fax: (516) 673-2848

DELAWARE

Harwood Associates

242 Welsh Ave.
Bellmawr, NJ 08031

Tel: (609) 933-1541
Fax: (609) 933-1520

FLORIDA

Conley Associates

3696 Ulmerton Rd.
Clearwater, FL 34622

Suite 222
1750 West Broadway St.
Oviedo, FL 32765

Tel: (813) 572-8895

Tel: (407) 365-3283
Fax: (407) 365-3727

GEORGIA

Electronic Marketing Associates

Suite 190
5855 Jimmy Carter Blvd.
Norcross, GA 30071

Tel: (770) 448-1215
Fax: (770) 446-9363

HAWAII

contact factory

Tel: (408) 944-0800

IDAHO (NORTHERN)

SPS Electronic Sales Incorporated

128 North Shore Circle
Oswego, OR 97034

Tel: (503) 697-7768
Fax: (503) 697-7764

IDAHO (SOUTHERN)

Lindberg Company

P.O. Box 526458
1095 East 2100 Street, #265-4
Salt Lake City, UT 84152

Tel: (801) 484-8689
Fax: (801) 484-9691

ILLINOIS

Janus, Incorporated

Suite 170
650 East Devon Ave.
Itasca, IL 60143

Tel: (630) 250-9650
Fax: (630) 250-8761

INDIANA

Applied Data Management

P.O. Box 213
Batesville, IN 47006

Tel: (317) 257-8949
Fax: (513) 579-8510

IOWA

J.R. Sales Engineering

1930 St. Andrews, NE
Cedar Rapids, IA 52402

Tel: (319) 393-2232
Fax: (319) 393-0109

KANSAS

Midwest Technical Sales

Suite 240
10,000 College Blvd.
Overland Park, KS 66210

Tel: (913) 338-2400
Fax: (913) 338-0404

13 Woodland Dr.

Augusta, KS 67010

Tel: (316) 775-2565
Fax: (316) 775-3577

KENTUCKY

Crest Component Sales

Mike Kilroy Corporation
12360 Hemple Road
Farmersville, OH 45325

Tel: (513) 696-2277
Fax: (513) 696-2246

LOUISIANA

Kruvand Associates Inc.

Suite 113
1202 Richardson Dr.
Richardson, TX 75080

Tel: (972) 437-3355
Fax: (972) 680-8854

MAINE

3D Sales

Suite 205
5 Burlington Woods
Burlington, MA 01803

Tel: (617) 229-2999
Fax: (617) 229-2033

MARYLAND

Burgin-Kreh Associates, Inc.

Suite 330
7000 Security Blvd.
Baltimore, MD 21244

Tel: (410) 265-8500
Fax: (410) 265-8536

MASSACHUSETTS

Byrne Associates (*Digital Equipment Corp. only*)

125 Conant Rd.
Weston, MA 02193

Tel: (617) 899-3439
Fax: (617) 899-0774

3D Sales (*except Digital Equipment Corp.*)

Suite 205
5 Burlington Woods
Burlington, MA 01803

Tel: (617) 229-2999
Fax: (617) 229-2033

MICHIGAN

Applied Data Management

1925 Pauline Blvd., Ste. D
Ann Arbor, MI 48103

Tel: (313) 741-9292
Fax: (313) 741-9292

18761 Blakely

Woodhaven, MI 48183

Tel: (313) 675-6327
Tel: (513) 579-8108
Fax: (313) 675-7154

MINNESOTA

George Russell Associates

Suite 114
8030 Cedar Ave. South
Minneapolis, MN 55425

Tel: (612) 854-1166
Fax: (612) 854-6799

MISSISSIPPI

CSR Electronics

Suite 931
303 Williams Ave.
Huntsville, AL 35801

Tel: (205) 533-2444
Fax: (205) 536-4031

MISSOURI

Midwest Technical Sales

Suite 149
4203 Earth City Expressway
Earth City, MO 63045

Tel: (314) 298-8787
Fax: (314) 298-9843

MONTANA

Lindberg Company

Suite 21
5701 East Evans Ave.
Denver, CO 80222

Tel: (303) 758-9033
Fax: (303) 758-5863

NEBRASKA

J.R. Sales Engineering
1930 St. Andrews, NE
Cedar Rapids, IA 52402
Tel: (319) 393-2232
Fax: (319) 393-0109

NEVADA (NORTHERN)

Trinity Technologies, Inc.
1261 Oakmead Pkwy.
Sunnyvale, CA 94086
Tel: (408) 733-9000
Fax: (408) 733-9970

NEVADA (CLARK COUNTY)

O'Donnell Associates Southwest, Inc.
Suite 1026
2432 West Peoria Ave.
Phoenix, AZ 85029
Tel: (602) 944-9542
Fax: (602) 861-2615

NEW HAMPSHIRE

3D Sales
Suite 205
5 Burlington Woods
Burlington, MA 01803
Tel: (617) 229-2999
Fax: (617) 229-2033

NEW JERSEY (NORTHERN)

Harwood Associates
25 High St.
Huntington, NY 11743
Tel: (516) 673-1900
Fax: (516) 673-2848

NEW JERSEY (SOUTHERN)

Harwood Associates
242 Welsh Ave.
Bellmawr, NJ 08031
Tel: (609) 933-1541
Fax: (609) 933-1520

NEW MEXICO

O'Donnell Associates Southwest, Inc.
Suite 558
5959 Gateway, West
El Paso, TX 79925
Tel: (915) 778-2581
Fax: (915) 778-6429

NEW YORK

Harwood Associates
25 High St.
Huntington, NY 11743
Tel: (516) 673-1900
Fax: (516) 673-2848

NORTH CAROLINA

ACM, Inc.
206 New Addition Ct.
Cary, NC 27511
Tel: (919) 319-0900
Fax: (919) 319-3552

ACM, Inc.
6412 Lake Forrest Rd. East
Charlotte, NC 28227
Tel: (704) 568-2258
Fax: (704) 568-2258

NORTH DAKOTA

George Russell Associates
Suite 114
8030 Cedar Ave. South
Minneapolis, MN 55425
Tel: (612) 854-1166
Fax: (612) 854-6799

OHIO (NORTH)

Crest Component Sales
11681 Stafford Road
Burton, OH 44021
Tel: (216) 543-9808
Fax: (216) 543-9800

OHIO (SOUTH)

Crest Component Sales
The Mike Kilroy Corporation
12360 Hemple Road
Farmersville, OH 45325
Tel: (513) 696-2277
Fax: (513) 696-2246

OKLAHOMA

Kruvand Associates Inc.
Suite 113
1202 Richardson Dr.
Richardson, TX 75080
Tel: (972) 437-3355
Fax: (972) 680-8854

OREGON

SPS Electronic Sales Incorporated
128 North Shore Circle
Oswego, OR 97034
Tel: (503) 697-7768
Fax: (503) 697-7764

PENNSYLVANIA (EAST)

Harwood Associates
242 Welsh Ave.
Bellmawr, NJ 08031
Tel: (609) 933-1541
Fax: (609) 933-1520

PENNSYLVANIA (WEST)

Crest Component Sales
11681 Stafford Road
Burton, OH 44021
Tel: (216) 543-9808
Fax: (216) 543-9800

RHODE ISLAND

3D Sales
Suite 205
5 Burlington Woods
Burlington, MA 01803
Tel: (617) 229-2999
Fax: (617) 229-2033

SOUTH DAKOTA

George Russell Associates
Suite 114
8030 Cedar Ave. South
Minneapolis, MN 55425
Tel: (612) 854-1166
Fax: (612) 854-6799

SOUTH CAROLINA

ACM, Inc.
6412 Lake Forrest Rd. East
Charlotte, NC 28227
Tel: (704) 568-2258
Fax: (704) 568-2258

TENNESSEE

CSR Electronics
Suite 931
303 Williams Ave.
Huntsville, AL 35801
Tel: (205) 533-2444
Fax: (205) 536-4031

TEXAS

Kruvand Associates Inc.
Suite 109
11754 Jollyville Road
Austin, TX 78759
Tel: (512) 219-9443
Fax: (512) 219-1932

1314 Irish Mist
Katy, TX 77450
Tel: (713) 956-6741
Fax: (713) 395-5911

Suite 113
1202 Richardson Dr.
Richardson, TX 75080
Tel: (972) 437-3355
Fax: (972) 680-8854

TEXAS (EL PASO COUNTY)

O'Donnell Associates Southwest, Inc.
Suite 558
5959 Gateway, West
El Paso, TX 79925
Tel: (915) 778-2581
Fax: (915) 778-6429

UTAH

Lindberg Company
1095 East 2100 South, #265-4
P.O. Box 526458
Salt Lake City, UT 84152
Tel: (801) 484-8689
Fax: (801) 484-9691

VERMONT

3D Sales
Suite 205
Tel: (617) 229-2999
5 Burlington Woods
Fax: (617) 229-2033
Burlington, MA 01803

VIRGINIA

Burgin-Kreh Associates, Inc.
Suite 330
7000 Security Blvd.
Tel: (410) 265-8500
Baltimore, MD 21244
Fax: (410) 265-8536

WASHINGTON

SPS Electronic Sales Incorporated
Unit C216
21303 52nd Ave. West
Tel: (206) 672-8766
Mountlake Terrace, WA 98043
Fax: (206) 672-8766

WASHINGTON D.C.

Burgin-Kreh Associates, Inc.
Suite 330
7000 Security Blvd.
Tel: (410) 265-8500
Baltimore, MD 21244
Fax: (410) 265-8536

WEST VIRGINIA

Crest Component Sales
11681 Stafford Road
Tel: (216) 543-9808
Burton, OH 44021
Fax: (216) 543-9800

WISCONSIN

Janus, Incorporated
375 Williamstowne
Tel: (414) 646-5420
Delafield, WI 53018
Fax: (414) 646-5421

WYOMING

Lindberg Company
Suite 21
5701 East Evans Ave.
Tel: (303) 758-9033
Denver, CO 80222
Fax: (303) 758-5863

U.S. Distributors

ALABAMA

Bell Industries, Inc.
Suite 600D
555 Sparkmen Dr.
Huntsville, AL 35816

Tel: (205) 430-3150
Fax: (205) 430-3160

Future Electronics

Suite 400 A
6767 Old Madison Pike
Huntsville, AL 35806

Tel: (205) 971-2010
Fax: (205) 922-0004

Jaco Electronics, Inc.
Suite 404
9900 W. Sample Rd.
Coral Springs, FL 33065

Tel: (800) 777-9373
Fax: (954) 341-7874

Nu Horizons Electronics Corp.

Suite 10
4835 University Square
Huntsville, AL 35816

Tel: (205) 722-9330
Fax: (205) 722-9348

ARIZONA

Bell Industries, Inc.
Suite D-103
10611 North Hayden Rd.
Scottsdale, AZ 85260

Tel: (602) 905-2355
Fax: (602) 905-2356

FAI

Suite 245
4636 East University Dr.
Phoenix, AZ 85034

Tel: (602) 731-4661
Fax: (602) 731-9866

Future Electronics

Suite 245
4636 East University Dr.
Phoenix, AZ 85034

Tel: (602) 968-7140
Fax: (602) 968-0334

Jaco Electronics, Inc.

2432 West Peoria Ave., #1344
Phoenix, AZ 85029

Tel: (602) 906-4004
Fax: (602) 906-4054

CALIFORNIA (NORTHERN)

Active Electronics
1717 El Camino Real
Santa Clara, CA 95051

Tel: (408) 249-5494

Bell Industries, Inc.

Suite 205
3001 Douglas Blvd.
Roseville, CA 95661

Tel: (916) 781-8070
Fax: (916) 781-2954

1161 North Fairoaks Ave.
Sunnyvale, CA 94089

Tel: (408) 734-8570
Fax: (408) 734-8875

FAI

755 N. Sunrise Blvd., #150
Roseville, CA 95678

Tel: (916) 782-7882
Fax: (916) 783-7877

2220 O'Toole Ave.
San Jose, CA 95131

Tel: (408) 434-0369

Future Electronics

755 N. Sunrise Blvd., #150
Roseville, CA 95678

Tel: (916) 783-7877
Fax: (916) 783-7988

2220 O'Toole Ave.
San Jose, CA 95131

Tel: (408) 434-1122
Fax: (408) 433-0822

Integrated Electronics, Inc.

Suite 145
9940 Business Park Dr.
Sacramento, CA 95827

Tel: (916) 363-6030
Fax: (916) 362-6926

Jaco Electronics, Inc.

1610-A Berryessa Rd.
San Jose, CA 95133

Tel: (408) 928-1600
Tel: (800) 696-0948
Fax: (408) 928-1616

Nu Horizons Electronics Corp.

2070 Ringwood Ave.
San Jose, CA 95131

Tel: (408) 434-0800
Fax: (408) 434-0935

CALIFORNIA (SOUTHERN)

Active Electronics

25A Technology
Irvine, CA 92718

Tel: (714) 753-4778
Fax: (714) 753-1183

Bell Industries, Inc.

Suite 100
220 Technology Dr.
Irvine, CA 92718

Tel: (714) 727-4500
Fax: (714) 453-4610

Suite 205

5520 Ruffin Rd.
San Diego, CA 92123

Tel: (619) 576-3290
Fax: (619) 492-9826

Suite 110

125 Auburn Ct.
Westlake Village, CA 91362

Tel: (805) 373-5600
Fax: (805) 496-7340

FAI

Suite 310
27489 West Agoura Rd.
Agoura Hills, CA 91301

Tel: (818) 879-1234
Tel: (800) 274-0818
Fax: (818) 879-5200

Suite 200

25B Technology
Irvine, CA 92718

Tel: (714) 753-4778
Tel: (800) 967-0350
Fax: (714) 753-11835

Suite 220

5151 Shoreham Place
San Diego, CA 92122

Tel: (619) 623-2888
Fax: (619) 623-2891

Future Electronics

Suite 300
27489 West Agoura Rd.
Agoura Hills, CA 91301

Tel: (818) 865-0040
Tel: (800) 876-6008
Fax: (818) 865-1340

1692 Browning Ave.
Irvine, CA 92714

Tel: (714) 250-4141
Tel: (800) 950-2147
Fax: (714) 453-1226

Suite 220

5151 Shoreham Place
San Diego, CA 92122

Tel: (619) 625-2800
Fax: (619) 625-2810

Integrated Electronics Corp.

Suite 125
16 Technology Dr.
Irvine, CA 92718

Tel: (714) 753-0127
Fax: (714) 753-0831

Jaco Electronics, Inc.

1541 Parkway Loop, #A
Tustin, CA 92680

Tel: (714) 258-9003
Fax: (714) 258-1909

2282 Townsgate Rd.
Westlake, CA 91361

Tel: (805) 495-9998
Tel: (800) 350-9992
Fax: (805) 494-3864

Jan Devices Incorporated

6925 Canby, Bldg. 109
Reseda, CA 91335

Tel: (818) 757-2000
Fax: (818) 708-7436

Nu Horizons Electronics Corp.

Suite 123
13900 Alton Pkwy.
Irvine, CA 92718

Tel: (714) 470-1011
Fax: (714) 470-1104

Suite B
4360 View Ridge Ave.
San Diego, CA 92123

Tel: (619) 576-0088
Fax: (619) 576-0990

Suite 104

31225 La Baya Dr.
Westlake Village, CA 91362

Tel: (818) 889-9911
Fax: (818) 889-1771

COLORADO

Bell Industries, Inc.

Suite 460
9351 Grant St.
Thornton, CO 80229

Tel: (303) 280-1115
Fax: (303) 280-0005

FAI

Suite B150
12600 West Colfax Ave.
Lakewood, CO 80215

Tel: (303) 237-1400
Fax: (303) 232-2009

Integrated Electronics Corp.

5750 North Logan St.
Denver, CO 80216

Tel: (303) 292-6121
Fax: (303) 297-2053

Jaco Electronics, Inc.

695 Pierce St.
Erie, CO 80516

Tel: (303) 828-3074
Fax: (303) 828-3080

Suite 405

12445 East 39th Ave.
Denver, CO 80239

Tel: (303) 373-2766
Fax: (303) 373-4029

CONNECTICUT

Bell Industries, Inc.

1064 East Main St.
Meriden, CT 06450

Tel: (203) 639-6000
Fax: (203) 639-6005

FAI

Westgate Office Center
700 West Johnson Ave.
Cheshire, CT 06410

Tel: (203) 250-1319
Fax: (203) 250-0081

Nu Horizons Electronics Corp.

100 Mill Plain Rd.
Danbury, CT 06811

Tel: (203) 265-0162
Fax: (203) 791-3801

FLORIDA

Bell Industries, Inc.

Suite 400
650 South North Lake Blvd.
Altamonte Springs, FL 32701

Tel: (407) 339-0078
Fax: (407) 339-0139

Suite 170

1499 West Palmetto Park Rd.
Boca Raton, FL 33486

Tel: (407) 338-3203
Fax: (407) 338-4129

FAI

Suite 307
237 South Westmonte Dr.
Altamonte Springs, FL 32701

Tel: (407) 685-7900
Tel: (800) 333-9719
Fax: (407) 865-5969

Suite 200

1400 East Newport Center Dr.
Deerfield Beach, FL 33442-4219

Tel: (954) 626-4043
Tel: (800) 305-8181
Fax: (954) 426-9477

Suite 108

2200 Tall Pines Dr.
Largo, FL 34641

Tel: (813) 530-1665
Fax: (813) 538-9598

Future Electronics

Suite 307
237 South Westmonte Dr.
Altamonte Springs, FL 32714

Tel: (407) 865-7900
Tel: (800) 950-0168
Fax: (407) 865-7660

Suite 200
1400 East Newport Center Dr.
Deerfield Beach, FL 33442

Tel: (954) 426-4043
Tel: (800) 305-2343
Fax: (954) 426-3939

Jaco Electronics, Inc.

Suite 404
9900 West Sample Rd.
Coral Springs, FL 33065

Tel: (954) 341-8280
Tel: (800) 776-5226
Fax: (954) 341-7848

Nu Horizons Electronics Corp.

Suite 270
600 South North Lake Blvd.
Altamonte Springs, FL 32701

Tel: (407) 831-8008
Fax: (407) 831-8862

3421 Northwest 55th St.
Ft. Lauderdale, FL 33309

Tel: (954) 735-2555
Fax: (954) 735-2880

GEORGIA

Bell Industries, Inc.

Suite D
3000 Business Park Dr.
Norcross, GA 30071

Tel: (770) 446-2333
Fax: (770) 446-7264

FAI

Suite 130
3150 Holcomb Bridge Rd.
Norcross, GA 30071

Tel: (404) 441-7676

Future Electronics

Suite 130
3150 Holcomb Bridge Rd.
Norcross, GA 30071

Tel: (404) 441-7676
Fax: (404) 441-7580

Jaco Electronics, Inc.

5206 Greens Dairy Rd.
Raleigh, NC 27604

Tel: (919) 876-7767
Fax: (919) 876-6964

Nu Horizons Electronics Corp.

Suite 155
100 Pinnacle Way
Norcross, GA 30071

Tel: (770) 416-8666
Fax: (770) 416-9060

IDAHO

Future Electronics

12301 W. Explorer Dr.
Boise, ID 83713

Tel: (208) 376-8080

ILLINOIS

Active Electronics

1776 West Golf Rd.
Mount Prospect, IL 60056

Tel: (847) 640-7713

Bell Industries, Inc.

870 Cambridge Dr.
Elk Grove Village, IL 60007

Tel: (847) 640-3270
Fax: (847) 640-1926

FAI

Suite 160
3150 West Higgins Rd.
Hoffman Estates, IL 60195

Tel: (847) 882-1255
Tel: (800) 283-1899
Fax: (847) 843-1163

Future Electronics

Suite 200
3150 West Higgins Rd.
Hoffman Estates, IL 60195

Tel: (847) 882-1255
Tel: (800) 490-9290
Fax: (847) 490-9290

Integrated Electronics Corp.

Suite 1505
2401 West Hassell Rd.
Hoffman Estates, IL 60195

Tel: (847) 843-2040
Fax: (847) 843-2320

Jaco Electronics, Inc.

101 East Commerce Dr.
Schaumburg, IL 60173

Tel: (847) 884-6620
Fax: (847) 884-7573

INDIANA

Bell Industries, Inc.

525 Airport North Office Park
Fort Wayne, IN 46825

Tel: (219) 422-4300
Fax: (219) 490-2400

6982 Hillsdale Ct.
Indianapolis, IN 46250

Tel: (317) 842-4244
Fax: (317) 570-1344

Future Electronics

Suite 175
8425 Woodfield Crossing
Indianapolis, IN 46240

Tel: (317) 469-0441
Fax: (317) 469-0452

IOWA

Dee Electronics, Inc.

P.O. Box 1508
2500 16th Ave., SW
Cedar Rapids, IA 52406

Tel: (319) 365-7551
Fax: (319) 365-8506

KANSAS

Future Electronics

Suite 150
8826 Sante Fe Dr.
Overland Park, KS 66212

Tel: (913) 381-6800
Fax: (913) 381-6899

MARYLAND

Bell Industries, Inc.

Suite 130
8945 Guilford Rd.
Columbia, MD 21046

Tel: (410) 290-5100
Fax: (410) 290-8006

FAI

Suite F
1530 Caton Center Dr.
Baltimore, MD 21227

Tel: (410) 536-5400
Fax: (410) 536-5406

Future Electronics

Suite 101
6716 Alexander Bell Dr.
Columbia, MD 21046

Tel: (410) 290-0600
Fax: (410) 290-0328

Jaco Electronics, Inc.

Rivers Center
10270 Old Columbia Rd.
Columbia, MD 21046

Tel: (410) 995-6620
Fax: (410) 995-6032

Nu Horizons Electronics Corp.

Suite 160
8965 Guilford Rd.
Columbia, MD 21046

Tel: (410) 995-6330
Tel: (301) 621-8244
Fax: (410) 995-6332

MASSACHUSETTS

Active Electronics

11 Cummings Park
Woburn, MA 01801

Tel: (617) 932-0050

Bell Industries, Inc.

Suite 106
100 Burt Rd.
Andover, MA 01810

Tel: (508) 474-8880
Fax: (508) 474-8902

FAI

41 Main St.
Bolton, MA 01740

Tel: (508) 779-3111
Fax: (508) 779-3199

Future Electronics

41 Main St.
Bolton, MA 01740

Tel: (508) 779-3000
Fax: (508) 779-3050

Jaco Electronics, Inc.

1053 East St.
Tewksbury, MA 01876

Tel: (508) 640-0010
Fax: (508) 640-0755

Nu Horizons Electronics Corp.

19 Corporate Place, Bldg. 1
107 Audubon Rd.
Wakefield, MA 01880

Tel: (617) 246-4442
Fax: (617) 246-4462

MICHIGAN

FAI

Suite 100
1393 Wheaton
Troy, MI 48083

Tel: (313) 698-8000

Future Electronics

4505 Broadmoor, SE
Grand Rapids, MI 49512

Tel: (616) 698-6800
Fax: (616) 698-6821

Suite 106

35200 Schoolcraft Rd.
Livonia, MI 48150

Tel: (313) 261-5270
Fax: (313) 261-8175

RM Electronics Company, Inc.

4375 Donker Ct., SE
Kentwood, MI 49512

Tel: (616) 977-0900
Fax: (616) 977-0053

MINNESOTA

Bell Industries, Inc.

Suite 142
9401 James Ave. South
Bloomington, MN 55431

Tel: (612) 888-7747
Fax: (612) 888-7757

FAI

Suite 198
10025 Valley View Rd.
Eden Prairie, MN 55344

Tel: (612) 974-0909
Fax: (612) 944-2520

Future Electronics

Suite 196
10025 Valley View Rd.
Eden Prairie, MN 55344

Tel: (612) 944-2200
Fax: (612) 944-2520

Jaco Electronics, Inc.

Suite 115
10340 Viking Dr.
Eden Prairie, MN 55344

Tel: (612) 941-2757
Fax: (800) 844-5226
Fax: (612) 941-1989

Nu Horizons Electronics Corp.

6955 Washington Ave. South
Edina, MN 55439

Tel: (612) 942-9030
Fax: (612) 942-9144

Voyager Electronics Corp.

Suite 303
5201 East River Road
Fridley, MN 55421

Fax: (612) 571-7766
Fax: (612) 571-9519

MISSOURI

FAI

Suite 220
12125 Woodcrest Executive Dr.
St. Louis, MO 63141

Tel: (314) 542-9922
Fax: (314) 542-9655

Future Electronics

Suite 220
12125 Woodcrest Executive Dr.
St. Louis, MO 63141

Tel: (314) 469-6805
Fax: (314) 469-7226

NEVADA

Competitive Components

Unit K
7310 Smoke Ranch Rd.
Las Vegas, NV 89128

Tel: (702) 233-0967
Fax: (702) 233-0947

NEW JERSEY

Active Electronics

Heritage Square
1871 Route 70
Cherryhill, NJ 08034

Tel: (609) 424-7070

Bell Industries, Inc.

Suites F202-203
271 Route 46 West
Fairfield, NJ 07004

Tel: (201) 227-6060
Fax: (201) 227-2626

Suite 110

158 Gaither Dr.
Mount Laurel, NJ 08054

Tel: (609) 439-8860
Fax: (609) 439-9009

- FAI**
Suite 130
12 East Stow Rd.
Marlton, NJ 08053
Tel: (609) 988-1500
Fax: (609) 988-9231
- Future Electronics**
Suite 200
12 East Stow Rd.
Marlton, NJ 08053
Tel: (609) 596-4080
Fax: (609) 596-4266
- 1259 Route 46 East
Parsippany, NJ 07054
Tel: (201) 299-0400
Fax: (201) 299-1377
- Nu Horizons Electronics Corp.**
Suite 200
18000 Horizon Way
Mt. Laurel, NJ 08054
Tel: (609) 231-0900
Fax: (609) 231-9510
- 39 U.S. Route 46
Pine Brook, NJ 07058
Tel: (201) 882-8300
Fax: (201) 882-8398
- NEW YORK**
- Active Electronics**
3075 Veteran's Memorial
Ronkonkoma, NY 11779
Tel: (516) 471-5400
- Bell Industries, Inc.**
Suite 217
300 Vanderbilt Motor Pkwy.
Hauppauge, NY 11788
Tel: (516) 435-8910
Fax: (516) 435-8913
- FAI**
801 Motor Pkwy.
Hauppauge, NY 11788
Tel: (516) 240-3700
Fax: (516) 234-6183
- Future Electronics**
300 Linden Oaks
Rochester, NY 14625
Tel: (716) 387-9600
Fax: (716) 387-9563
- Suite 130
200 Salina Meadows Pkwy.
Syracuse, NY 13212
Tel: (315) 451-4405
Fax: (315) 451-7258
- Jaco Electronics, Inc.**
145 Oser Ave.
Hauppauge, NY 11788
Tel: (516) 273-5500
Fax: (516) 273-5799
- Nu Horizons Electronics Corp.**
6000 New Horizons Blvd.
Amityville, NY 11701
Tel: (516) 226-6000
Fax: (516) 226-6140
- 333 Metro Park
Rochester, NY 14623
Tel: (716) 292-0777
Fax: (716) 292-0750
- NORTH CAROLINA**
- Bell Industries, Inc.**
Suite 800
3100 Smoketree Ct.
Raleigh, NC 27604
Tel: (919) 874-0011
Fax: (919) 874-0013
- Future Electronics**
Suite 108
8401 University Executive Park
Charlotte, NC 28262
Tel: (704) 547-1107
- Suite 314
Smith Towers
Charlotte Motor Speedway
P.O. Box 600
Concord, NC 28026
Tel: (704) 455-9030
Fax: (704) 455-9173
- 1 North Commerce Center
5225 Capital Blvd.
Raleigh, NC 27604
Tel: (919) 876-0088
Fax: (919) 790-9022
- Jaco Electronics, Inc.**
5206 Greens Dairy Rd.
Raleigh, NC 27604
Tel: (919) 876-7767
Fax: (919) 876-6964
- Nu Horizons Electronics Corp.**
Suite 200
6200 Falls of the Neuse Rd.
Raleigh, NC 27609
Tel: (800) 929-5383
Fax: (770) 416-9060
- OHIO**
- Bell Industries, Inc.**
444 Windsor Park Dr.
Dayton, OH 45459
Tel: (513) 435-5922
Fax: (513) 435-3122
- Suite 11
31200 Solon Rd.
Solon, OH 44139
Tel: (216) 498-2002
Fax: (216) 498-2006
- Bell Industries, Inc. (Military)**
446 Windsor Park Dr.
Dayton, OH 45459
Tel: (513) 434-8231
Fax: (513) 434-8103
- FAI**
Suite 203
1430 Oak Ct.
Beavercreek, OH 45430
Tel: (513) 427-6090
Fax: (216) 449-8987
- Future Electronics**
Suite 203
1430 Oak Ct.
Beavercreek, OH 45430
Tel: (513) 426-0090
Fax: (513) 426-8490
- Nu Horizons Electronics Corp.**
2208 Enterprise E. Pkwy.
Twinsburg, OH 44087
Tel: (216) 963-9933
Fax: (216) 963-9944
- OKLAHOMA**
- Jaco Electronics**
12943 East 28th Pl.
Tulsa, OK 74134
Tel: (918) 438-6002
Fax: (918) 438-6002
- OREGON**
- Bell Industries, Inc.**
Suite 100
8705 Southwest Nimbus Ave.
Beaverton, OR 97008
Tel: (503) 644-3444
Fax: (503) 520-1948
- Future Electronics**
Cornell Oaks Corp. Center
15236 NW Greenbrier Pkwy.
Beaverton, OR 97006
Tel: (503) 645-9454
Fax: (503) 645-1559
- Integrated Electronics Corp.**
Suite 102
3720 Southwest 141st St.
Beaverton, OR 97005
Tel: (503) 641-1690
Fax: (503) 646-3737
- Jaco Electronics Inc.**
Suite 129
4900 Southwest Griffith Dr.
Beaverton, OR 97005
Tel: (503) 626-1439
Tel: (800) 245-5226
Fax: (503) 626-0979
- PENNSYLVANIA**
- Bell Industries, Inc.**
Suite 110
158 Gaither Dr.
Mount Laurel, NJ 08054
Tel: (609) 439-8860
Fax: (609) 439-9009
- Future Electronics**
Suite 200
12 East Stow Rd.
Marlton, NJ 08053
Tel: (609) 596-4080
Fax: (609) 596-4266
- Nu Horizons Electronics Corp.**
Suite 200
18000 Horizon Way
Mt. Laurel, NJ 08054
Tel: (215) 557-6450
Fax: (609) 231-9510
- TEXAS**
- Bell Industries, Inc.**
Suite 170
14110 Dallas Pkwy.
Dallas, TX 75240
Tel: (972) 458-0047
Fax: (972) 404-0267
- Suite 263
10700 Richmond
Houston, TX 77042
Tel: (713) 974-2111
Fax: (713) 974-2117
- FAI**
Suite 126
800 East Campbell
Richardson, TX 75081
Tel: (972) 231-7195
Tel: (800) 272-0694
Fax: (972) 231-2508
- Suite 137E
6800 Park Ten Blvd.
San Antonio, TX 78213
Tel: (210) 738-3330
Fax: (210) 738-0511
- Future Electronics**
Ste. 610, Bldg. II
9020 Capital Texas Hwy. N.
Austin, TX 78759
Tel: (512) 346-6426
Fax: (512) 346-6781
- Suite 970
10333 Richmond Ave.
Houston, TX 77042
Tel: (713) 952-7088
Tel: (203) 250-0083
Fax: (713) 952-7098
- Suite 130
800 East Campbell
Richardson, TX 75081
Tel: (972) 437-2437
Tel: (203) 250-0083
Fax: (972) 669-2347
- Jaco Electronics, Inc.**
2120-A Braker Lane
Austin, TX 78758
Tel: (512) 835-0220
Fax: (512) 339-9252
- 1209 North Glenville Dr.
Richardson, TX 75081
Tel: (972) 234-5565
Fax: (972) 238-7068
- Nu Horizons Electronics Corp.**
Suite F-29
7801 N. Lamar
Austin, TX 78752
Tel: (512) 467-2292
Fax: (512) 467-2466
- Suite 119
2081 Hutton Dr.
Carrollton, TX 75006
Tel: (214) 488-2255
Tel: (800) 200-1586
Fax: (214) 488-2265
- US Connections Inc.**
Suite 140
8850 Jemeel Rd.
Houston, TX 77040
Tel: (713) 460-8160
Fax: (713) 460-8220
- UTAH**
- Bell Industries, Inc.**
Suite B
6912 South 185 West
Midvale, UT 84047
Tel: (801) 561-9691
Fax: (801) 255-2477
- FAI**
Suite 301
3450 South Highland Dr.
Salt Lake City, UT 84106
Tel: (801) 467-9696
Fax: (801) 467-9755
- Future Electronics**
Suite 301
3450 South Highland Dr.
Salt Lake City, UT 84106
Tel: (801) 467-4448
Fax: (801) 467-3604
- Integrated Electronics Corp.**
Technology Park
2117 South 3600 West
W. Valley City, UT 84119
Tel: (801) 977-9750
Fax: (801) 975-1207
- VIRGINIA**
- FAI**
Suite 202
660 Hunters Pl.
Charlottesville, VA 22911
Tel: (804) 563-7312
Fax: (804) 984-5422
- WASHINGTON**
- Active Electronics**
13107 Northup Way 20th St., NE
Bellevue, WA 98005
Tel: (206) 881-8191
- Bell Industries, Inc.**
Suite 208
1715 114th Ave., SE
Bellevue, WA 98004
Tel: (206) 646-8750
Fax: (206) 646-8559

FAI

13107 Northup Way 20th St., NE
Bellevue, WA 98005 Tel: (206) 485-6166

Future Electronics

North Creek Corporate Center
Suite 118
19102 North Creek Pkwy. Tel: (206) 489-3400
Bothell, WA 98011 Fax: (206) 489-3411

Integrated Electronics Corp.

1750-124th Ave., NE Tel: (206) 455-2727
Bellevue, WA 98005 Fax: (206) 453-2963

Jaco Electronics, Inc.

Suite 300 Tel: (206) 481-3372
17220 127th Pl. NE Tel: (800) 245-5226
Woodinville, WA 98072 Fax: (206) 481-1664

VESCO

716 Industry Dr. Tel: (206) 575-3607
Tukwila, WA 98188 Fax: (206) 575-1965

WISCONSIN**Bell Industries, Inc.**

W 226 N 900 Eastmound Tel: (414) 547-8879
Waukesha, WI 53186 Fax: (414) 547-6547

FAI

Suite 170
250 North Patrick Blvd. Tel: (414) 793-9778
Brookfield, WI 53045 Fax: (414) 792-9779

Future Electronics

Suite 170
250 North Patrick Blvd. Tel: (414) 879-0244
Brookfield, WI 53045 Fax: (414) 879-0250

Marsh Electronics

1563 South 101st St. Tel: (414) 475-6000
Milwaukee, WI 53214 Fax: (414) 711-2847

Taylor Electric Company

1000 West Donges Bay Rd. Tel: (414) 241-4321
Mequon, WI 53092 Fax: (414) 241-4025

International Sales Representatives and Distributors

AUSTRALIA**GEC Electronics Division**

38 South Street, Unit 1 Tel: + 61 (2) 638 1888
 Rydalmere, NSW 2116 Fax: + 61 (2) 898 0176

AUSTRIA**Steiner Electronic Vertrieb GmbH**

Egererstraße 18 Tel: + 43 (2233) 55 3 66-0
 3013 Tullnerback Fax: + 43 (2233) 55 3 60

BELGIUM**Microtron N.V.**

Generaal DeWittelaan 7 Tel: + 32 (15) 21.22.23
 2800 Mechelen Fax: + 32 (15) 21.00.69

BRAZIL**Aplicacoes Electronicas Artimar Ltda.**

10º Andar Tel: + 55 (11) 231-0277
 Rua Marques de Itu 70 Fax: + 55 (11) 255-0511
 01223-000 São Paulo - SP

CANADA**Electronic Sales Professionals Inc. (Representative)**

104-215 Stafford Rd. Tel: (613) 828-6881
 Nepean, ON K2H 9C1 Fax: (613) 828-5725

Suite 204
 137 Main Street North
 Markham, ON L3P 1Y2
 Tel: (905) 294-3520
 Fax: (905) 294-3806

CANADA—ALBERTA**Active Electronics**

Unit 1
 2015 32nd Ave., NE Tel: (403) 291-5626
 Calgary, AB T2E 6Z3 Fax: (403) 291-5444

Future Active Industrial

Unit 1
 2015 32nd Ave., NE Tel: (403) 291-5333
 Calgary, AB T2E 6Z3 Fax: (403) 291-5444

Future Active Industrial

6029 103rd St. Tel: (403) 438-5888
 Edmonton, AB T6H 2H3 Fax: (403) 436-1874

Future Electronics

3833 - 29th St., NE Tel: (403) 250-5550
 Calgary, AB T1Y 6B5 Fax: (403) 291-7054

Future Electronics

4606 - 97th St. Tel: (403) 438-2858
 Edmonton, AB T6E 5N9 Fax: (403) 434-0812

CANADA—BRITISH COLUMBIA**Active Electronics**

100 S.E. Marine Dr. Tel: (604) 654-1057
 Vancouver, BC V5X 2S3 Fax: (604) 324-3100

Future Active Industrial

1695 Boundary Road Tel: (604) 654-1050
 Vancouver, BC V5K 4X7 Fax: (604) 294-3170

Future Electronics

1695 Boundary Road Tel: (604) 294-1166
 Vancouver, BC V5K 4X7

CANADA—MANITOBA**Future Active Industrial**

106 King Edward St. East Tel: (204) 786-3075
 Winnipeg, MB R3H 0N8 Fax: (204) 783-8133

Future Electronics

106 King Edward St. East Tel: (204) 944-1446
 Winnipeg, MB R3H 0N8 Fax: (204) 783-8133

CANADA—ONTARIO**Active Electronics**

Unit 2
 1350 Matheson Blvd. Tel: (905) 238-8825
 Mississauga, ON L4W 4M1 Fax: (905) 238-2817

1023 Merivale Road
 Ottawa, ON K1Z 6A6
 Tel: (613) 728-7900
 Fax: (613) 728-3586

100 Lombard St.
 Toronto, ON M5C 1M3
 Tel: (416) 367-2911
 Fax: (416) 367-4706

Future Active Industrial

Suite 205/210
 5935 Airport Rd. Tel: (613) 820-8244
 Mississauga, ON L4V 1W5 Fax: (613) 820-8046

Future Electronics

Baxter Center
 1050 Baxter Road Tel: (613) 820-8313
 Ottawa, ON K2C 3P2 Fax: (613) 820-3271

CANADA—QUEBEC**Active Electronics**

Suite 190
 1990 Boul. Charest Ouest Tel: (418) 682-5775
 Ste. Foy, PQ G1N 4K8 Fax: (418) 682-6282

Future Active Industrial

5651 Ferrier St. Tel: (514) 731-7444
 Montreal, PQ H4P 1N1 Fax: (514) 731-0129

6080 Metropolitan Blvd.
 Montreal, PQ H1S 1A9
 Tel: (514) 256-7538
 Fax: (514) 256-4890

Future Electronics

Suite 100
 1000 Ave. St. Jean Baptiste Tel: (418) 877-6666
 Quebec, PQ G2E 5G5 Fax: (418) 877-6671

237 Hymus Blvd.
 Pointe Claire, PQ H9R 5C7
 Tel: (514) 694-7710
 Fax: (514) 695-3707

CHINA**Lestina International Ltd.**

Room 20404
 Friendship Hotel
 No. 3 Bai Shi Qiao Road Tel: + 86 (10) 8499430
 Beijing 100873 Fax: + 86 (10) 8499430

248 Sha Yang Road
 Sha Ping Ba
 Chongqing 630030
 Tel: + 86 (811) 5315258
 Fax: + 86 (811) 5315258

Room 2301, Tower 1
 14 Huang Hua Road
 Guangzhou 510053
 Tel: + 86 (20) 3807307
 Fax: + 86 (20) 3807307

No. 3-1, Fuxing Bridge
 Houzai Door
 Nanjing 210016
 Tel: + 86 (25) 4491384
 Fax: + 86 (25) 4491384

DENMARK**Ditz Schweitzer**

Titangade 15 Tel: + 45 35 86 90 90
 2200 Copenhagen Fax: + 45 35 86 90 60

FINLAND**Integrated Electronics Oy Ab**

Laurinmäenkuja 3 Tel: + 358 (9) 586 1770
 00440 Helsinki Fax: + 358 (9) 586 1771

P.O. Box 31
 00441 Helsinki

FRANCE**LSX S.A.R.L. (Representative)**

30, rue du Morvan SILIC Tel: + 33 (1) 46.87.83.36
 94633 Rungis cedex Fax: + 33 (1) 45.60.07.84

LSX S.A.R.L. (Representative)

B.P. 82
 7, Chemin de la Segue Tel: + 33 (5) 56.78.89.14
 33611 Cestas cedex Fax: + 33 (5) 57.83.56.21

Future Electronics

Parc Technopolis
 Bat. theta 2 LP854 Les Ulis
 3, avenue du Canada Tel: + 33 (1) 69.82.11.11
 91940 Courtaboeuf cedex Fax: + 33 (1) 69.82.11.00

3D-PEP

6-8, rue Ambroise Croizat Tel: + 33 (1) 64 47 29 29
 91127 Palaiseau cedex Fax: + 33 (1) 64 47 00 84

GERMANY**KaMa GmbH (Representative)**

Hauptstraße 19 Tel: + 49 (62 37) 20 72
 67133 Maxdorf Fax: + 49 (62 37) 5 93 36

C.E.D. Ditricon GmbH

Julius-Hölder-Straße 42 Tel: + 49 (7 11) 72 00 10
 70597 Stuttgart Fax: + 49 (7 11) 7 28 97 80

dacom Electronic Vertriebs GmbH

Freisinger Straße 13 Tel: + 49 (89) 9 96 54 90
 85737 Ismaning Fax: + 49 (89) 96 49 89

Future Electronics Deutschland GmbH

München Straße 18 Tel: + 49 (89) 95 72 70
 85774 Unterföhring Fax: + 49 (89) 95 72 71 73

HONG KONG**Lestina International Ltd.**

14th Floor, Park Tower
 15 Austin Road
 Tsimshatsui Tel: + 852 27351736
 Kowloon Fax: + 852 27305260

INDIA**Samura Electronics Pvt. Ltd.**

Room No. 507 W
 Navketan Commercial Complex Tel: + 91 (40) 7806541
 62, S. D. Road Tel: + 91 (40) 7806542
 Secunderabad - 500003 Fax: + 91 (40) 7806542

+ country code (city code) telephone number

IRELAND

Future Electronics
Post Office Lane
Abbey Street
Ennis, County Clare

Tel: + 353 (65) 41330
Fax: + 353 (65) 40654

ISRAEL

EI-GeV Electronics, Ltd.
POB 50 Building 101
73142 Tirat-Yehuda

Tel: + 972 (3) 9712056
Fax: + 972 (3) 9712407

ITALY

Future Electronics S.r.l.
Via Fosse Ardeantine 4
20092 Cinisello Balsamo (MI)

Tel: + 39 (2) 66012763
Fax: + 39 (2) 66012843

Carlo Gavazzi Cefra S.p.A.
Via G. De Castro, 4
20144 Milano

Tel: + 39 (2) 48012355
Fax: + 39 (2) 48008167

JAPAN

Micro Summit K.K. (Stocking Representative)

Premier K1 Bldg.
1 Kanda Mikura-cho
Chiyoda-ku
Tokyo 101

Tel: + 81 (3) 3258-5531
Fax: + 81 (3) 3258-0433

Nippon Imex Corporation

No. 6 Sanjo Bldg., 5F
1-46-9 Matsubara Setagaya-ku
Tokyo 156

Tel: + 81 (3) 3321-8000
Fax: + 81 (3) 3325-0021

KOREA

Shinwa Corporation

2F. The Christian Literature Society
of Korea Bldg.
169-1, Samsung-Dong
Kangnam-Ku
Seoul

Tel: + 82 (2) 554-6431
Fax: + 82 (2) 554-7649

MALAYSIA

JAG Components (Pte.) Ltd.

Ruby Industrial Complex
Genting Block
80 Genting Lane, #11-06A
Singapore 349565

Tel: + 65 749 56 63
Fax: + 65 749 56 62

MEXICO

Harwood Associates Mexico (Representative)

Anguila 3627
Col. Loma Bonita
44590 Zapopan, Jalisco

Tel: + 52 (3) 634-99-27
Fax: + 52 (3) 634-62-56

Future Electronics Mexico S.A. de C.V.

5º Piso, Suite 2
Chimalhuacán 3569
Ciudad del Sol
45050 Zapopan, Jalisco

Tel: + 52 (3) 122-00-43
Fax: + 52 (3) 122-10-66

NETHERLANDS

Nijkerk Elektronika B.V.

Drentestraat 7
1083 HK Amsterdam

Tel: + 31 (20) 504 14 35
Fax: + 31 (20) 642 39 48

NEW ZEALAND

VSI Electronics (N.Z.) Ltd.

274 Church Street
Penrose, Auckland

Tel: + 64 (9) 636 7801
Fax: + 64 (9) 634 4900

P.O. Box 92821
Penrose, Auckland

NORWAY

Power & Systems Norway AS

Postboks 84
Vestvollveien 10
2020 Skedsmokorset

Tel: + 47 63 89 89 89
Fax: + 47 63 87 59 00

PHILIPPINES

Crystalsem Incorporated

216 Ortega Street
San Juan, Metro Manila 1500

Tel: + 63 (2) 79 05 29
Fax: + 63 (2) 722 1006

SINGAPORE

JAG Components (Pte.) Ltd.

Ruby Industrial Complex
Genting Block
80 Genting Lane, #11-06A
Singapore 349565

Tel: + 65 749 56 63
Fax: + 65 749 56 62

SOUTH AFRICA

Prime Source (Pty.) Ltd.

Prime Source House
3 Olympia Street
Marlboro, Sandton

Tel: + 27 (11) 444 7237
Fax: + 27 (11) 444 7298

P.O. Box 46169
Orange Grove 2119

SPAIN

Unitronics Componentes, S.A.

Pza. Espana, 18, PL9
28008 Madrid

Tel: + 34 (1) 542 52 04
Fax: + 34 (1) 548 42 28

SWEDEN

Quantum Electronics AB (Representative)

Girovagen 13
175 62 Jarfälla

Tel: + 46 (8) 621 03 35
Fax: + 46 (8) 621 03 99

Pelcon Electronics AB

Girovagen 13
175 62 Jarfälla

Tel: + 46 (8) 795 98 70
Fax: + 46 (8) 760 76 85

SWITZERLAND

Electronitel SA

Ch. du Grand-Clos 1
B.P. 142
1752 Villars-sur-Glâne 1

Tel: + 41 (26) 401 00 60
Fax: + 41 (26) 401 00 70

ENA AG

Postfach
8917 Oberlunkhofen

Tel: + 41 (56) 634 28 34
Fax: + 41 (56) 634 14 43

TAIWAN, R.O.C.

Galaxy Far East Corp.

8F-6, No. 390, Section 1
Fu Hsing South Road
Taipei

Tel: + 886 (2) 705-7266
Fax: + 886 (2) 708-7901

THAILAND

JAG Components (Pte.) Ltd.

Ruby Industrial Complex
Genting Block
80 Genting Lane, #11-06A
Singapore 349565

Tel: + 65 749 56 63
Fax: + 65 749 56 62

UNITED KINGDOM

Silicon Concepts Ltd. (Stocking Representative)

PEC Lynchborough Road
Passfield, Liphook
Hampshire GU30 7SB

Tel: + 44 (1428) 751617
Fax: + 44 (1428) 751603

Solid State Supplies Ltd. (Stocking Representative)

Unit 2, Eastlands Lane
Paddock Wood
Kent TN12 6BU

Tel: + 44 (1892) 836836
Fax: + 44 (1892) 837837

Future Electronics Ltd.

Future House
Poyle Road
Colnbrook
Berkshire SL3 0EZ

Tel: + 44 (1753) 763000
Fax: + 44 (1753) 689100

Gothic Crellon Ltd.

3 The Business Centre
Molly Millars Lane
Wokingham
Berkshire RG11 2EY

Tel: + 44 (1734) 788878
Fax: + 44 (1734) 776095

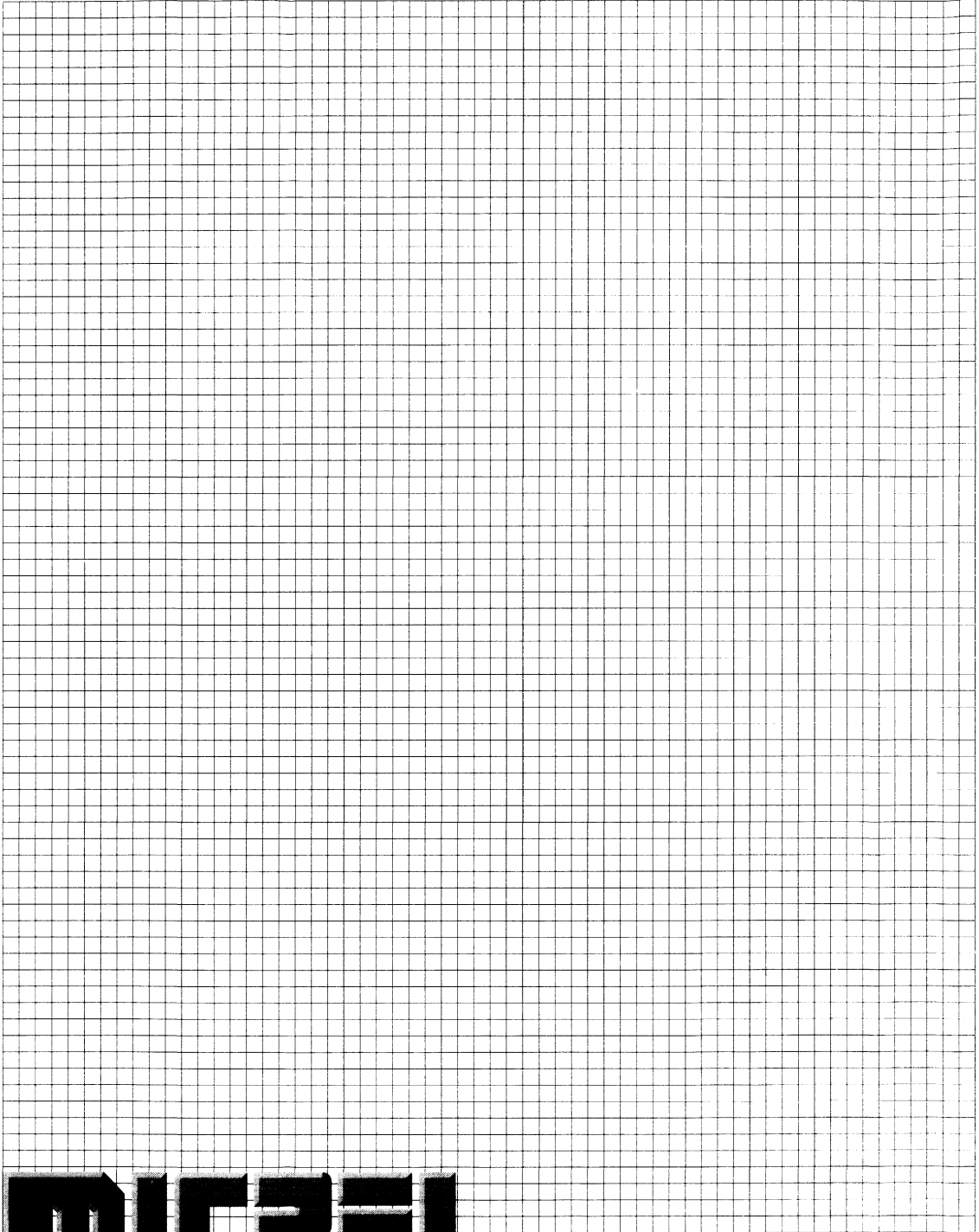

MICREL